

A Guide for Private and Commercial Applicators

# Applying Pesticides Correctly

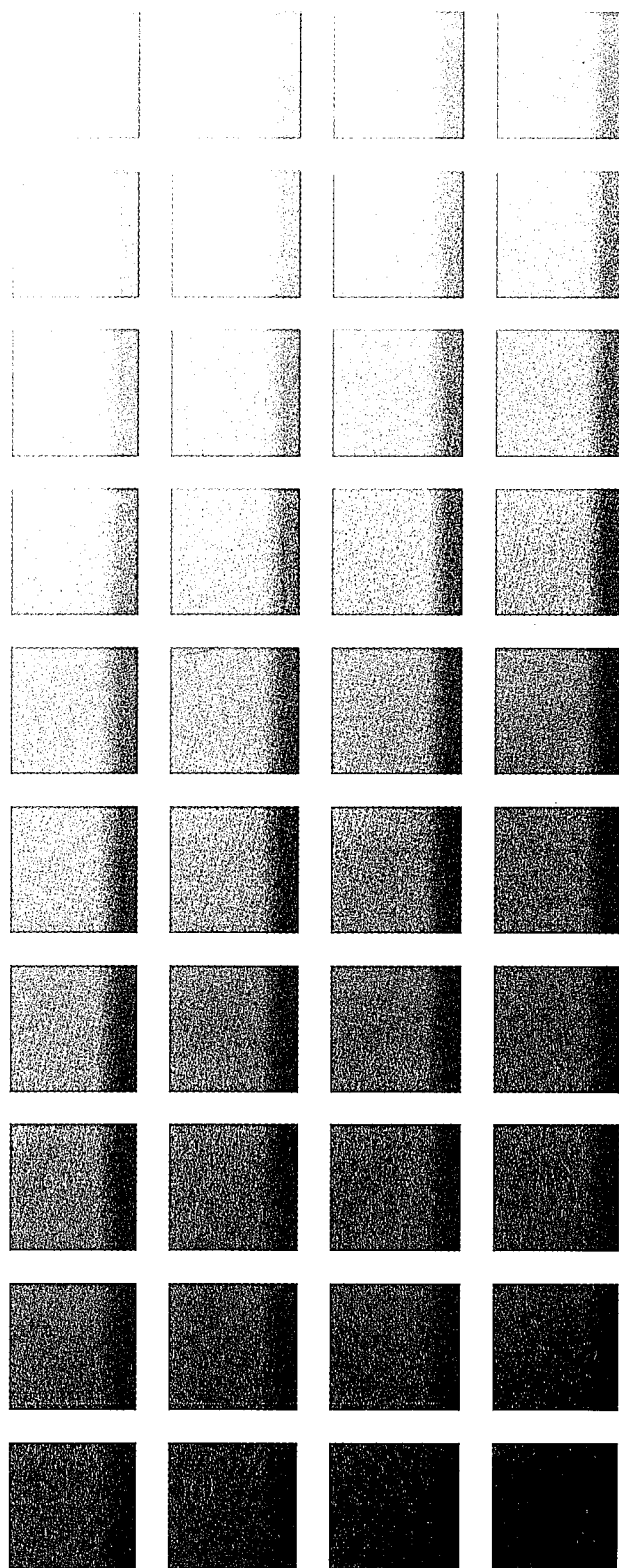

C

C

C

# Principles of Pest Control

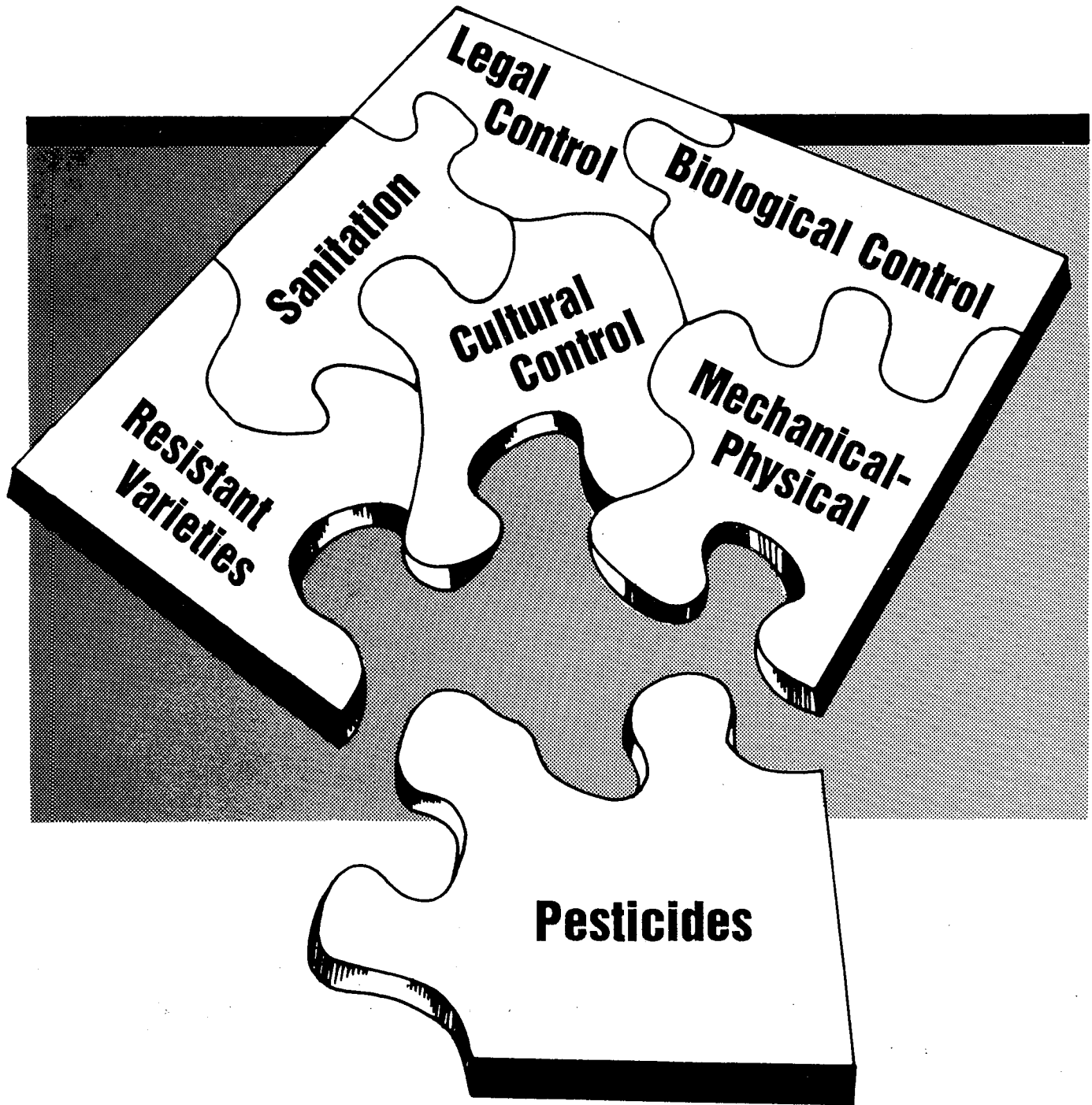

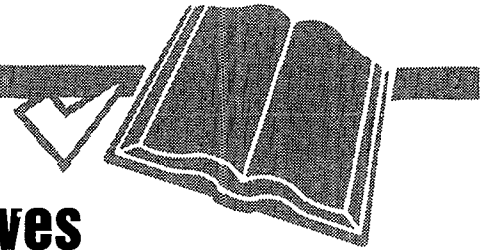
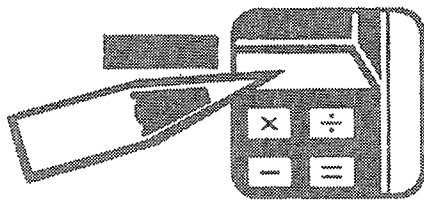

## Learning Objectives

After you complete your study of this unit, you should be able to:

- Explain why identification of the pest is the first step in developing an effective pest control strategy.
- Explain the differences between continuous pests, sporadic pests, and potential pests.
- Explain what is meant by prevention, suppression, and eradication of pests.
- Describe “thresholds” and why they are an important consideration in developing a pest control strategy.
- Describe “monitoring” as it relates to pest control and explain why it is important to pest control strategy.
- Define “integrated pest management” and list several possible control tactics that may be used in an IPM strategy.
- Name factors that can cause pesticide applications to fail to control pests.
- Name ways to help avoid the development of pest resistance to pesticides.

## Terms To Know

**Host** — A plant or animal on or in which a pest lives.

**Juvenile hormones** — Natural insect chemicals that keep the earlier stages of an insect from changing into the normal adult form.

**Labeling** — The pesticide product label and other accompanying materials that contain directions that pesticide users are legally required to follow.

**Mycoplasmas** — The smallest known living organisms that can reproduce and exist apart from other living organisms. They obtain their food from plants.

**Nematodes** — Small, usually microscopic, eel-like roundworms.

**Nontarget organism** — Any plant or animal other than the pest that is being controlled.

**Parasite** — An organism living on, in, or with another living organism for the purpose of obtaining food.

**Pathogen** — An organism that causes disease in other organisms.

**Pheromones** — Chemicals emitted by an organism to influence the behavior of other organisms of the same species.

**Predator** — An organism that attacks, kills, and feeds on other organisms.

**Scouting** — Regularly searching for, identifying, and assessing numbers of pests and the damage they are causing.



# Applying Pesticides Correctly

## A Guide for Private and Commercial Applicators

### Bulletin 825



United States  
Environmental Protection Agency



Extension Service, United States  
Department of Agriculture



 For Sale Publication

Copyright © The Ohio State University, 1992

All educational programs conducted by Ohio State University Extension are available to clientele on a nondiscriminatory basis without regard to race, color, creed, religion, sexual orientation, national origin, gender, age, disability or Vietnam-era veteran status.

Reprinted with permission of the Ohio State University Extension, 1992. President for Ag. Adm. and Director, OSU Extension

TDD No. 800-589-8292 (Ohio only) or 614-292-1868

Reprinted 10/00—5M—184437

This publication is issued by Ohio State University Extension, with permission of the U.S. Environmental Protection Agency and the Extension Service, U.S. Department of Agriculture.

## Preface

This manual represents the second revision of "Applying Pesticides Correctly — A Guide for Private and Commercial Applicators." The series began with separate guides for private and commercial applicators published jointly by the U.S. Department of Agriculture (USDA) and the U.S. Environmental Protection Agency (EPA) in 1974. Those manuals were a part of the initial implementation of the applicator training requirements of the Federal Insecticide, Fungicide, and Rodenticide Act of 1972. They established a threshold level of information necessary for applicators seeking initial certification.

The first revision, in 1983, recognized the need for private and commercial applicators to have a common basis of knowledge about pesticide use. It combined the two 1974 publications into an expanded and updated "core" manual for use by both groups of applicators. Produced by North Carolina State University and Information Impact, in cooperation with USDA and EPA, it included new information and represented a step towards more depth of knowledge for certified applicators.

This second revision reflects the continuing evolution of the applicator certification program. Pesticide use has become increasingly complex. Safe, responsible pesticide use has become increasingly important to human health and environmental quality. This new manual includes much new information about the effects of pesticides and how to ensure that they can continue to be used for the

benefit of society with a minimum of risk to either people or the environment.

Another major change is in the focus of the manual. The previous versions, while giving much basic information, were slanted toward agricultural pesticide use. Recognizing that more and more applicants for certification come from fields other than agriculture, this version has taken a broad approach. The "core" of information it contains is, in general, applicable to the entire range of categories in which certification is granted.

Finally, this revision constitutes a major change in the format of the core manual. The information is contained in separate units, or modules, that each contain learning objectives and review questions and answers. The structure allows for replacement of individual units, as needed, without the need to revise and renumber the entire book. Since the modules are not numbered, training agencies can organize them to suit their individual needs and can add or delete units as appropriate.

This project, which has the support of both the Extension Service, USDA, and the Office of Pesticide Programs, EPA, represents the continuation of a long-standing effort to ensure that pesticide applicator training is relevant and useful to applicators who seek certification and that it fulfills the purpose of improving the safety and efficacy of pesticide use.

## Acknowledgments

This manual, "Applying Pesticides Correctly," was produced by The Ohio State University and Information Impact, in cooperation with the Extension Service, U.S. Department of Agriculture, and the Office of Pesticide Programs, U.S. Environmental Protection Agency.

Principal participants in the project were:

Sally A. McDonald, Information Impact — primary author and compiler.

Mary Ann Wamsley, Information Impact — editor and reading level advisor.

John K. Victor, Mary Hoffelt, Jodi Barnhill, and Jackie Marthey, Section of Information and Applied Communications in the Ohio Cooperative Extension Service at The Ohio State University — artists and graphic designers.

Richard C. Funt, The Ohio State University — project coordinator.

Members of The Ohio State University Advisory Committee included:

Richard C. Funt, Department of Horticulture, Chair  
Mark Headings, Agricultural Technical Institute

Joanne Kick-Raack, Pesticide Applicator Training

Richard Lindquist, Department of Entomology

Erdal Ozkan, Department of Agricultural

Engineering

Charles Powell, Jr., Department of Plant Pathology

Celeste Welty, Department of Entomology

The following people are especially acknowledged for their thorough reviews and constructive suggestions:

Karen Angulo, Environmental Protection Agency

Robert Bellinger, Clemson University

Burton C. Evans, University of Georgia  
Ronald Gardner, Cornell University

Several printed sources were particularly crucial to the development of this manual:

"Agricultural Respiratory Hazards Education Series, Unit 9, Personal Protective Equipment". 1986. C. Mutel, C. Hradek, and W. Pependorf. American Lung Association of Iowa, Des Moines, Iowa.

"Personal & Environmental Safety". 1990. Lab Safety Supply, Janesville, Wisconsin.

"Pesticide Applicator Training Manual, Core Manual". 1990. D. Rutz, R. Gardner, and W. Smith. Chemicals-Pesticides Program, Cornell University, Ithaca, NY.

"Pesticide Education Manual, A Guide to Safe Use and Handling". C. Brown and W. Hock. The Pennsylvania State University, University Park, Pennsylvania.

"Recognition and Management of Pesticide Poisonings". 1989. D.P. Morgan. Fourth Edition. Iowa Pesticide Hazard Assessment Project, The University of Iowa College of Medicine, Iowa City, Iowa.

Thanks go also to the many other reviewers who took the considerable time necessary to read the draft manuscript and to offer comments and suggestions. Each had a significant hand in ensuring that this final version represents the best and most up-to-date information available about the safe use of pesticides. These reviewers included Cooperative Extension Service pesticide coordinators, EPA headquarters and regional personnel, NIOSH personnel, and other experts from the pesticide industry.

# Contents

## **Unit 1 Principles of Pest Control**

- Pests ■ Pest Control ■ Integrated Pest Management ■ Pest Control Failures

## **Unit 2 Pesticide Labeling**

- EPA Approval of Pesticide Labeling ■ Classification of Pesticide Uses
- Parts of Pesticide Labeling

## **Unit 3 Formulations**

- Liquid Formulations ■ Dry Formulations ■ Fumigants ■ Adjuvants

## **Unit 4 Pesticides in the Environment**

- Sources of Contamination ■ Sensitive Areas ■ Pesticide Movement
- Harmful Effects on Nontarget Plants and Animals ■ Harmful Effects on Surfaces

## **Unit 5 Special Environmental Concerns — Protecting Ground Water and Endangered Species**

- Sources of Ground Water ■ Pesticide Contamination of Ground Water
- The Certified Applicator's Role ■ Limitations on Pesticide Use
- Habitats of Endangered Species ■ Importance of Protecting Endangered Species
- The Certified Applicator's Role

## **Unit 6 Harmful Effects and Emergency Response**

- Exposure ■ Toxicity ■ Harmful Effects ■ Signs and Symptoms of Harmful Effects
- Responding to a Poisoning Emergency ■ Heat Stress

## **Unit 7 Personal Protective Equipment**

- Chemical-Resistant Personal Protective Equipment ■ Protecting Your Skin
- Protecting Your Eyes ■ Protecting Your Respiratory Tract
- Personal Protective Equipment for Handling Fumigants ■ Disposables and Reusables
- Maintaining Personal Protective Equipment

## **Unit 8 Pesticide Handling Decisions**

- Personal Safety Considerations ■ Pre-Application Decisions ■ Avoid Heat Stress

## **Unit 9 Mixing, Loading, and Application**

- Safe Mixing and Loading Practices ■ Applying Pesticides Safely
- After Mixing, Loading, and Application ■ Safety Systems

## **Unit 10 Applying the Correct Amount**

- Deciding How Much To Apply ■ Mixing, Loading, and Calibration Alternatives
- Calibrating Your Equipment ■ Calibration Methods ■ Measure Accurately

## **Unit 11 Transportation, Storage, Disposal, and Spill Cleanup**

- Transportation of Pesticides ■ Pesticide Storage ■ Disposal ■ Spill Management

## **Appendix Effects of Pesticides on the Human Body**

**A** pest is anything that:

- competes with humans, domestic animals, or desirable plants for food or water,
- injures humans, animals, desirable plants, structures, or possessions,
- spreads disease to humans, domestic animals, wildlife, or desirable plants,
- annoys humans or domestic animals.

## Types of Pests

Types of pests include:

- insects, such as roaches, termites, mosquitoes, aphids, beetles, fleas, and caterpillars,
- insect-like organisms, such as mites, ticks, and spiders,
- microbial organisms, such as bacteria, fungi, nematodes, viruses, and mycoplasmas,
- weeds, which are any plants growing where they are not wanted,
- mollusks, such as snails, slugs, and shipworms, and
- vertebrates, such as rats, mice, other rodents, birds, fish, and snakes.

Most organisms are not pests. A species may be a pest in some situations and not in others. An organism should not be considered



a pest until it is proven to be one.

Categories of pests include:

- **continuous** pests that are nearly always present and require regular control.
- **sporadic, migratory, or cyclical** pests that require control occasionally or intermittently.
- **potential** pests that do not require control under normal conditions, but may require control in certain circumstances.

## Pest Identification

Accurate identification is the first step in an effective pest management program. Never attempt a pest control program until you are sure of what the pest is. The more you know about the pest and the factors that influence its development and spread, the easier, more cost-effective, and more successful your pest control

will be. Correct identification of a pest allows you to determine basic information about it, including its life cycle and the time that it is most susceptible to being controlled.

As a certified applicator, you must be familiar with the pests you are likely to encounter in the type of work in your certification category. To be able to identify and control pests, you need to know:

- the physical features of the pests likely to be encountered,
- characteristics of the damage they cause,
- their development and biology,
- whether they are continuous, sporadic, or potential pests, and
- what your control goal is.

If you need help in identifying a pest, contact your commodity or industry organization, Cooperative

Extension agent, or State land-grant university.

## Pest Control

Any time you are considering whether pest control is necessary, remember:

**Control a pest only when it is causing or is expected to cause more harm than is reasonable to accept.**

**Use a control strategy that will reduce the pest numbers to an acceptable level.**

**Cause as little harm as possible to everything except the pest.**

Even though a pest is present, it may not do very much harm. It could cost more to control the pest than would be lost because of the pest's damage.

## Pest Control Goals

Whenever you try to control a pest, you will want to achieve one of these three goals, or some combination of them:

- prevention — keeping a pest from becoming a problem,
- suppression — reducing pest numbers or damage to an acceptable level, and
- eradication — destroying an entire pest population.

**Prevention** may be a goal when the pest's presence or abundance can be predicted in advance. Continuous pests, by definition, are usually very predictable. Sporadic and potential pests may be predictable if you know the circumstances or conditions that will favor their presence as pests. For example, some plant diseases occur only under certain environmental conditions. If such conditions are present, you can take steps to prevent the plant disease organisms from harming the desirable plants.

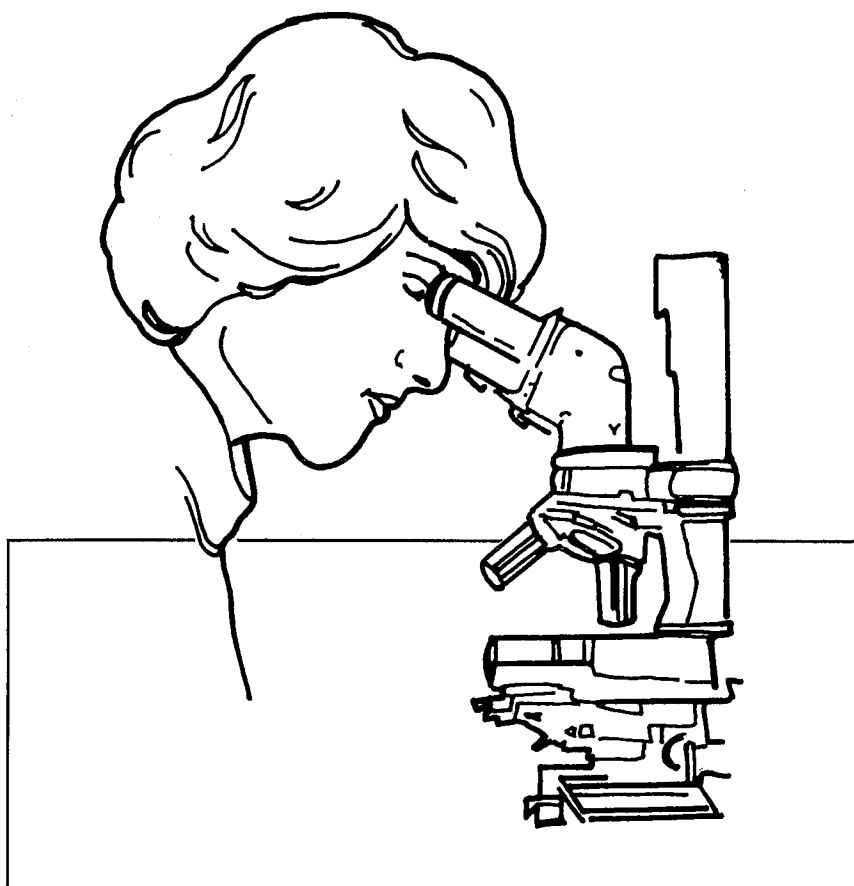

**Suppression** is a common goal in many pest situations. The intent is to reduce the number of pests to a level where the harm they are causing is acceptable. Once a pest's presence is detected and the decision is made that control is necessary, suppression and prevention often are joint goals. The right combination of control measures can often suppress the pests already present and prevent them from building up again to a level where they are causing unacceptable harm.

**Eradication** is a rare goal in outdoor pest situations, because it is difficult to achieve. Usually the goal is prevention and/or suppression. Eradication is occasionally attempted when a foreign pest has been accidentally introduced but is not yet established in an area. Such eradication strategies often

are supported by the Government. Mediterranean fruit fly, gypsy moth, and fire ant control programs are examples.

In indoor areas, eradication is a more common goal. Enclosed environments usually are smaller, less complex, and more easily controlled than outdoor areas. In many enclosed areas, such as dwellings; schools; office buildings; and health care, food processing, and food preparation facilities, certain pests cannot or will not be tolerated.

## Threshold Levels

Thresholds are the levels of pest populations at which you should take pest control action if you want to prevent the pests in an area from causing unacceptable injury or harm. Thresholds may be based on esthetic, health, or

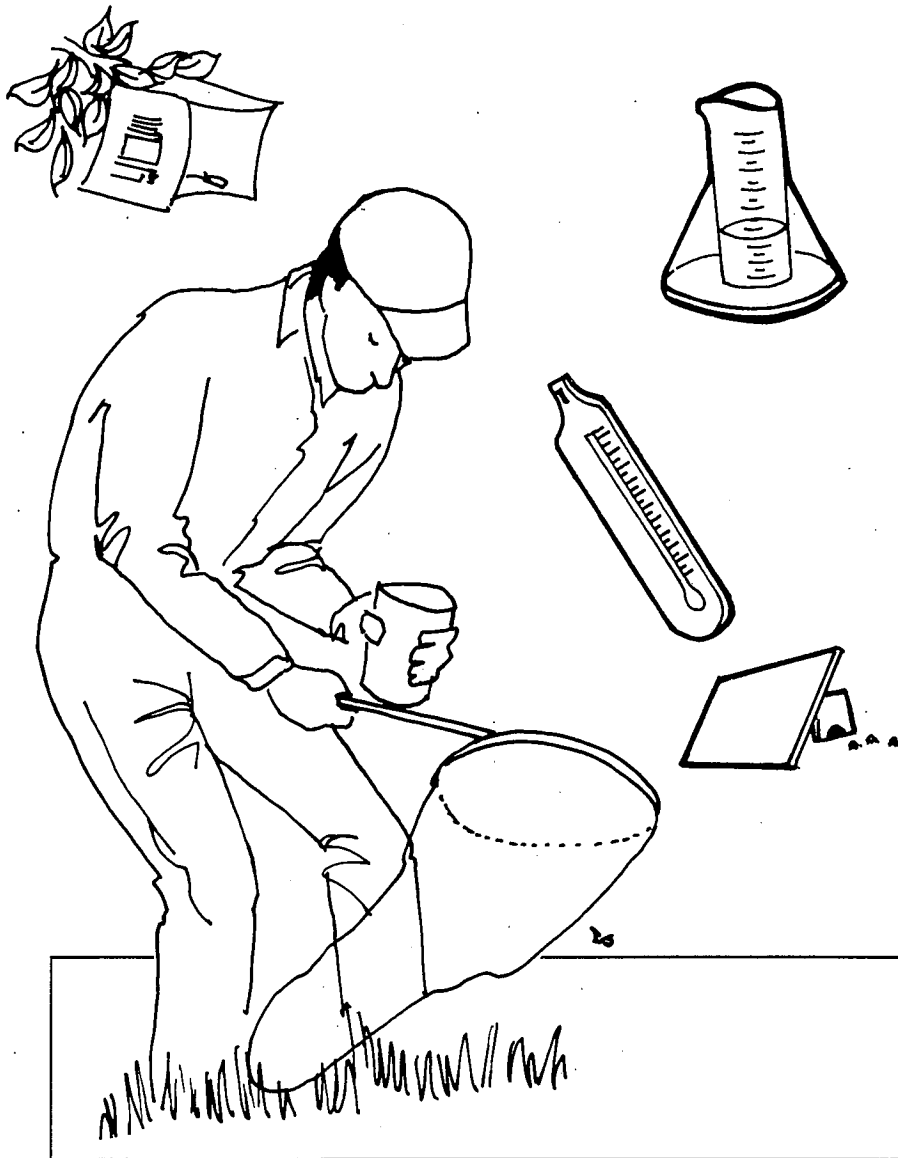

economic considerations. These levels, which are known as “action thresholds,” have been determined for many pests.

A threshold often is set at the level where the economic losses caused by pest damage, if the pest population continued to grow, would be greater than the cost of controlling the pests. These types of action thresholds sometimes are called “economic thresholds.”

In some pest control situations, the threshold level is zero: even a single pest in such a situation is unreasonably harmful. For example, the presence of any rodents in food processing facilities forces action. In homes, people generally

take action to control some pests, such as rodents or roaches, even if only one or a few have been seen.

### **Pest Monitoring**

In most pest control situations, the area to be protected should be monitored (checked or scouted) often. Regular monitoring can answer several important questions:

- What kinds of pests are present?
- Are the numbers great enough to warrant control?
- When is the right time to begin control?
- Have the control efforts successfully reduced the number of pests?

Monitoring of insect, insect-like, mollusk, and vertebrate pests usually is done by trapping or by scouting. Monitoring of weed pests usually is done by visual inspection. Monitoring for microbial pests is done by looking for the injury or damage they cause.

Monitoring also can include checking environmental conditions in the area that is being managed. Temperature and moisture levels, especially humidity, are often important clues in predicting when a pest outbreak will occur or will hit threshold levels.

Monitoring is not necessary in situations where a pest is continually present and the threshold is zero. For example, there is zero tolerance for the presence of bacteria in operating rooms and other sterile areas of health care facilities. In these situations, routine pest control measures are taken to prevent pests from entering an area and to eradicate any pests that may be present.

### **Avoiding Harmful Effects**

Pest control involves more than simply identifying a pest and using a control tactic. The treatment site, whether it is an outdoor area or inside a structure, usually contains other living organisms (such as people, animals, and plants) and nonliving surroundings (such as air, water, structures, objects, and surfaces). All of these could be affected by the pest control measures you choose. Unless you consider the possible effects on the entire system within which the pest exists, your pest control effort could cause harm or lead to continued or new pest problems. Rely on your own good judgment and, when pesticides are part of the strategy, on the pesticide labeling.

Most treatment sites are disrupted to some degree by pest control strategies. The actions of every type of organism or component sharing the site usually affect the actions and well-being of many others. When the balance is disrupted, certain organisms may be destroyed or reduced in number, and others — sometimes the pests — may dominate.

## Integrated Pest Management

Integrated pest management is the combining of appropriate pest control tactics into a single plan (strategy) to reduce pests and their damage to an acceptable level. Using many different tactics to control a pest problem tends to cause the least disruption to the living organisms and nonliving surroundings at the treatment site. Relying only on pesticides for pest control can cause pests to develop resistance to pesticides, can cause outbreaks of other pests, and can harm surfaces or nontarget organisms. With some types of pests, use of pesticides as the only tactic will achieve very poor control.

To solve pest problems, you must:

- identify the pest or pests and determine whether control is warranted for each,
- determine your pest control goal(s),
- know what control tactics are available,
- evaluate the benefits and risks of each tactic or combination of tactics,
- choose a strategy that will be most effective and will cause the least harm to people and the environment,
- use each tactic in the strategy correctly,

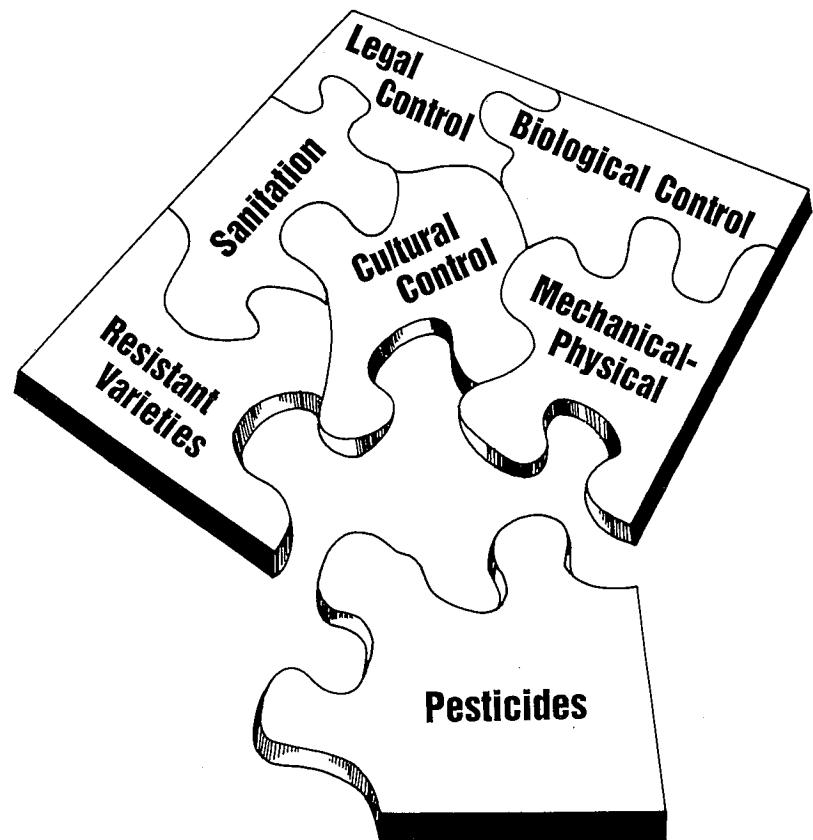

- observe local, State, and Federal regulations that apply to the situation.

The strategy you choose will depend on the pest you have identified and the kind and amount of control you need.

### Natural Controls

Some natural forces act on all organisms, causing the populations to rise and fall. These natural forces act independently of humans and may either help or hinder pest control. You may not be able to alter the action of natural forces on a pest population, but you should be aware of their influence and take advantage of them whenever possible. Natural forces that affect pest populations include climate, natural enemies, natural barriers,

availability of shelter, and food and water supplies.

### Climate

Weather conditions, especially temperature, day length, and humidity, affect pests' activity and their rate of reproduction. Pests may be killed or suppressed by rain, freezing temperatures, drought, or other adverse weather. Climate also affects pests indirectly by influencing the growth and development of their hosts. A population of plant-eating pests is related to growth of its host plants. Unusual weather conditions can change normal patterns so that increased or decreased damage results.



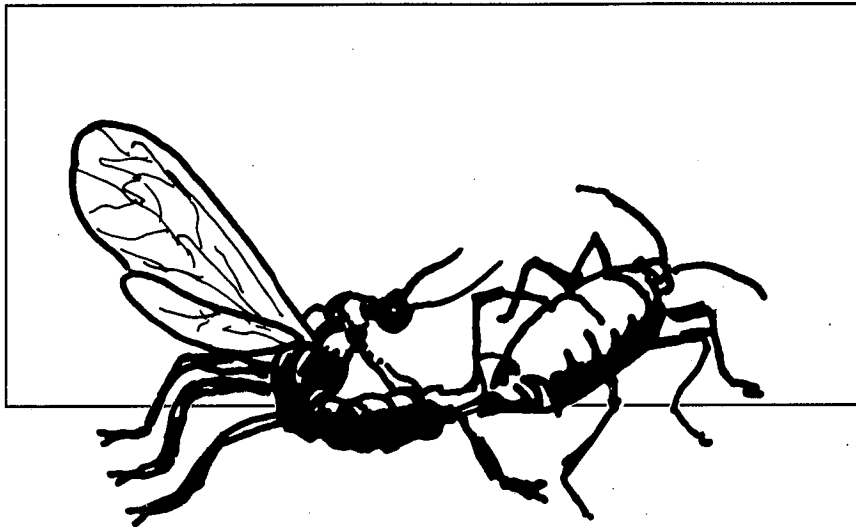

### **Natural enemies**

Birds, reptiles, amphibians, fish, and mammals feed on some pests and help control their numbers. Many predatory and parasitic insect and insect-like species feed on other organisms, some of which are pests. Pathogens often suppress pest populations.

### **Geographic barriers**

Features such as mountains and large bodies of water restrict the spread of many pests. Other features of the landscape can have similar effects.

### **Food and water supply**

Pest populations can thrive only as long as their food and water supply lasts. Once the food source — plant or animal — is exhausted, the pests die or become inactive. The life cycle of many pests depends on the availability of water.

### **Shelter**

The availability of shelter can affect some pest populations. Overwintering sites and places to hide from predators are important to the survival of some pests.

### **Applied Controls**

Unfortunately, natural controls often do not control pests quickly or completely enough to prevent unacceptable injury or damage.

Then other control measures must be used. Those available include:

- host resistance,
- biological control,
- cultural control,
- mechanical control,
- sanitation, and
- chemical control.

### **Host resistance**

Some plants, animals, and structures resist pests better than others. Some varieties of plants, wood, and animals are resistant to certain pests. Use of resistant types, when available, helps keep pest populations below harmful levels by making conditions less favorable for the pests.

Host resistance works in three main ways:

- Chemicals in the host repel the pest or prevent the pest from completing its life cycle.
- The host is more vigorous or tolerant than other varieties and thus less likely to be seriously damaged by pest attacks.
- The host has physical characteristics that make it more difficult to attack.

### **Biological control**

Biological control involves the use of natural enemies — parasites, predators, and pathogens. You can supplement this natural control by releasing more of a pest's enemies into the target area or by introducing new enemies that were not in the area before. Biological control usually is not eradication. The degree of control fluctuates. There is a time lag between pest population increase and the corresponding increase in natural controls. But, under proper conditions, sufficient control can be achieved to eliminate the threat to the plant or animal to be protected.

Biological control also includes methods by which the pest is biologically altered, as in the production and release of large numbers of sterile males and the use of pheromones or juvenile hormones.

Pheromones can be useful in monitoring pest populations. Placed in a trap, for example, they can attract the insects in a sample area so that pest numbers can be estimated. Pheromones also can be a control tool. Sometimes a manufactured copy of the pheromone that a female insect uses to attract males can be used to confuse males and prevent mating, resulting in lower numbers of pests. Applying juvenile hormones to an area can reduce pest numbers by keeping some immature pests from becoming normal, reproducing adults.

## Cultural control

Cultural practices sometimes are used to reduce the numbers of pests that are attacking cultivated plants. These practices alter the environment, the condition of the host plant, or the behavior of the pest to prevent or suppress an infestation. They disrupt the normal relationship between the pest and the host plant and make the pest less likely to survive, grow, or reproduce. Common cultural practices include rotating crops, cultivating the soil, varying time of planting or harvesting, planting trap crops, adjusting row width, and pruning, thinning, and fertilizing cultivated plants.

## Mechanical (physical) control

Devices, machines, and other methods used to control pests or alter their environment are called mechanical or physical controls. Traps, screens, barriers, fences, nets, radiation, and electricity sometimes can be used to prevent the spread of pests into an area.

Lights, heat, and refrigeration can alter the environment enough to suppress or eradicate some pest populations. Altering the amount of water, including humidity, can control some pests, especially insects and disease agents.

## Sanitation

Sanitation practices help to prevent and suppress some pests by removing the pests themselves or their sources of food and shelter. Urban and industrial pests can be reduced by improving



cleanliness, eliminating pest harborage, and increasing the frequency of garbage pickup. Management of pests attacking domestic animals is enhanced by good manure management practices. Carryover of agricultural pests from one planting to the next

can be reduced by removing crop residues.

Other forms of sanitation that help prevent pest spread include using pest-free seeds or transplants and decontaminating equipment, animals, and other possible carriers before allowing them to enter a pest-free area or leave an infested area. The proper design of food-handling areas can reduce access and shelter for many pests.

## Chemical control

Pesticides are chemicals used to destroy pests, control their activity, or prevent them from causing damage. Some pesticides either attract or repel pests. Chemicals that regulate plant growth or remove foliage also are classified as pesticides. Pesticides are generally the fastest way to control pests. In many instances, they are the only tactic available.

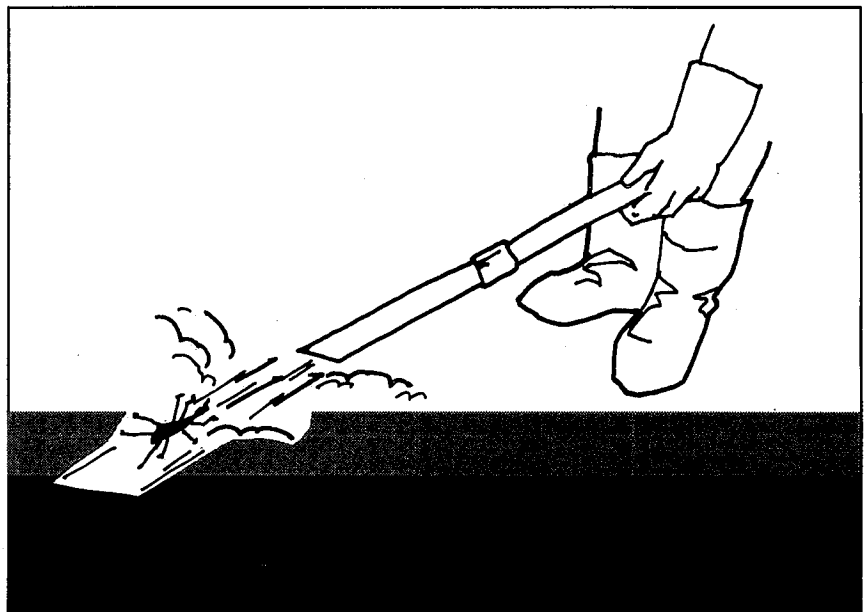

## Pest Control Failures

Sometimes you may find that even though you applied a pesticide, the pest has not been controlled. You should review the situation to try to determine what went wrong. There are several possible reasons for the failure of chemical pest control.

### Pest Resistance

Pesticides fail to control some pests because the pests are resistant to the pesticides. Consider this when planning pest control programs that rely on the use of pesticides. Rarely does any pesticide kill all the target pests. Each time a pesticide is used, it selectively kills the most susceptible pests. Some pests avoid the

pesticide. Others withstand its effects. Pests that are not destroyed may pass along to their offspring the trait that allowed them to survive.

When one pesticide is used repeatedly in the same place, against the same pest, the surviving pest population may be more resistant to the pesticide than the original population was. The opportunity for resistance is greater when a pesticide is used over a wide geographic area or when a pesticide is applied repeatedly to a rather small area where pest populations are isolated. A pesticide that leaves a residue that gradually loses its effectiveness over time will help select out resistance. Rotating pesticides may help reduce the development of pest resistance.

### Other Reasons for Failure

Not every pesticide failure is caused by pest resistance. Make sure that you have used the correct pesticide and the correct dosage and that you have applied the pesticide correctly. Sometimes a pesticide application fails to control a pest because the pest was not identified correctly and the wrong pesticide was chosen. Other applications fail because the pesticide was not applied at an appropriate time — the pest may not have been in the area during the application or it may have been in a life cycle stage or location where it was not susceptible to the pesticide. Also remember that the pests that are present may be part of a new infestation that developed after the chemical was applied.

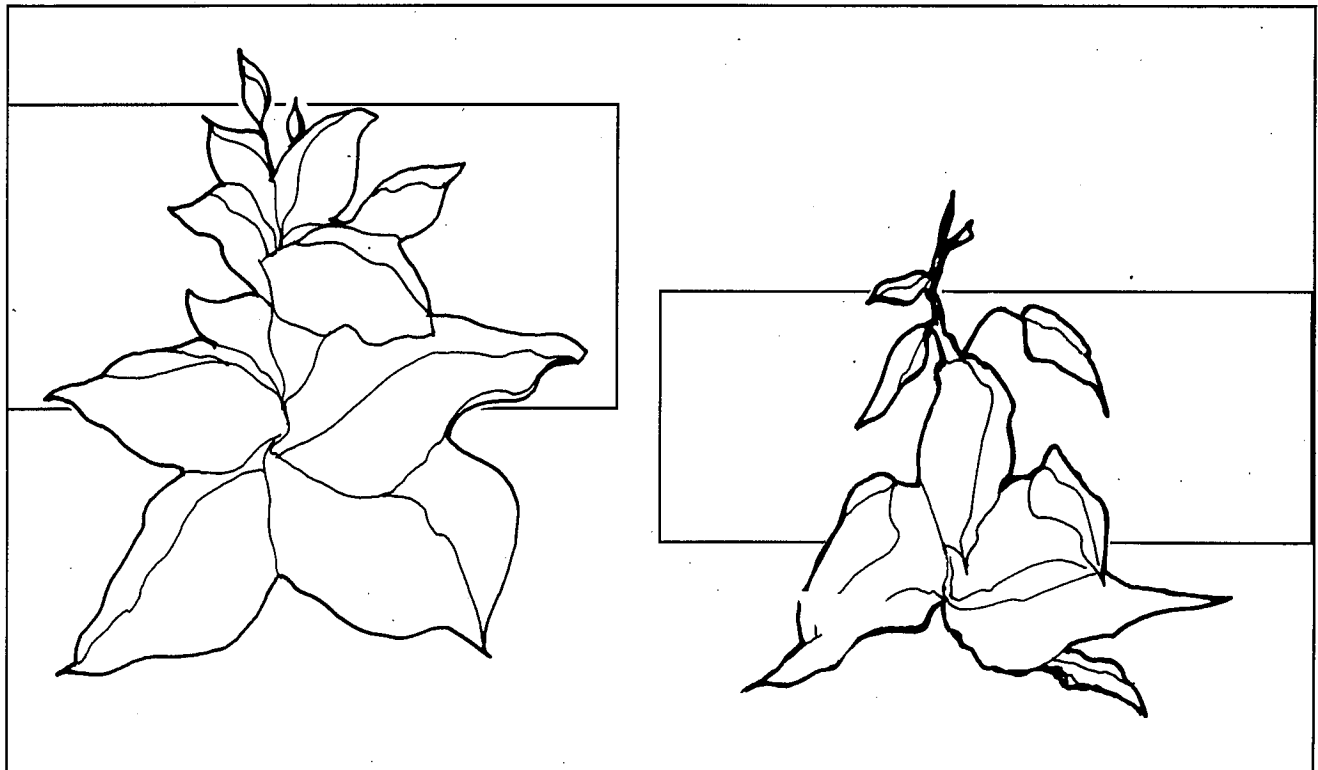



## Test Your Knowledge

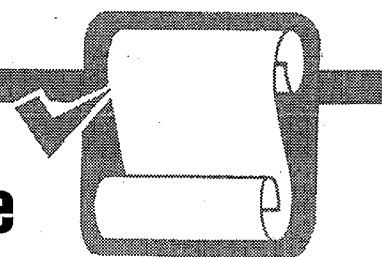

**Q.** What is the first thing you should do when you detect the presence of a pest that you think you may need to control?

**A.** Identify the pest to be sure you know exactly what the problem is.

**Q.** How can pest identification help you develop a good pest control strategy?

**A.** Identification of the pest allows you to determine basic information about it, including its life cycle and the time that it is most susceptible to being controlled.

**Q.** Explain the differences between continuous pests, sporadic pests, and potential pests.

**A.** Continuous pests are nearly always present and require regular control; sporadic pests are migratory, cyclical, or other occasional pests that require control once in a while, but not on a regular basis; potential pests are organisms that are not pests under normal conditions, but can become pests and require control in certain circumstances.

**Q.** Explain what is meant by prevention, suppression, and eradication of pests.

**A.** Prevention is keeping a pest from becoming a problem; suppression is reducing pest numbers or damage to an acceptable level; eradication is destroying an entire pest population.

**Q.** What is a threshold? Why should you consider thresholds when you develop a pest control strategy?

**A.** Thresholds are the levels of pest populations at which you must take pest control action to prevent unacceptable damage or injury. Use of threshold information can improve your pest control strategy by helping you make a decision about when to begin control tactics.

**Q.** Describe pest monitoring and explain how it can be important to pest control strategy.

**A.** Monitoring is checking or scouting for pests in an area to determine what pests are present, how many of each kind of pest are in the area, and how much damage they are causing. Monitoring is important to many pest control strategies, because it helps determine if the threshold has been reached and whether control measures have been effective.

**Q.** Define “integrated pest management” (IPM) and list several possible control tactics that may be used in an IPM strategy.

**A.** Integrated pest management is the combining of appropriate pest control tactics into a single plan to reduce pests and their damage to an acceptable level. Pest control tactics may include: host resistance, biological control, cultural control, mechanical control, sanitation, and chemical (pesticide) control.

**Q.** You applied a pesticide, but it did not control the pest. Name three reasons why your control effort might have failed.

**A.** The failure of the pesticide to control the pest might have been caused by pest resistance, choosing the wrong pesticide, misidentifying the pest, applying the wrong amount, or applying the pesticide incorrectly.

**Q.** What can you do to keep the pests you are trying to control from becoming resistant to the pesticides you use?

**A.** Pest resistance can be reduced by using integrated pest management and rotating the types of pesticides used.

# Pesticide Labeling



## PRECAUTIONARY STATEMENTS

### HAZARDS TO HUMANS (& DOMESTIC ANIMALS)

#### DANGER:

Fatal if absorbed through the skin, fatal if swallowed, and poisonous if inhaled. Do not breathe vapors or spray mist. Do not get on skin or clothing.

**SAFETY PRECAUTIONS** - Do not rub eyes or mouth with hands. If you feel sick in any way, STOP work and get help right away. **ON SKIN** - IMPORTANT! If pesticide comes in contact with skin, wash off with soap and water and contact a physician immediately. If handled indoors provide mechanical exhaust ventilation. Always wash hands, face and arms with soap and water before smoking, eating, drinking, or toileting.

### PERSONAL PROTECTIVE EQUIPMENT

Applicators and other handlers must wear:  
 Coveralls over long-sleeve shirt & long-legged pants  
 Chemical-resistant Gloves such as Butyl or Nitrile  
 Chemical-resistant Footwear plus socks  
 Eye Protection  
 Respirator with an organic vapor-removing cartridge and a prefilter approved for pesticides - MSHA/NIOSH approval prefix (23C) or canister approved for pesticides - MSHA/NIOSH approval number (14G)  
 Overhead applications: add Chemical-resistant wide-brimmed Hat or Hood  
 Mixers/Loaders and Cleaners of Equipment: add Chemical-resistant apron

## RESTRICTED USE PESTICIDE

Due to very high toxicity to humans and birds, use only by certified applicators or persons under their direct supervision and only as directed by the certified applicator's certification.

## DIRECTIONS FOR USE

It is a violation of Federal law to use this product in a manner inconsistent with its labeling.

Re-ent hours a and equ elsewhere states m: for variou your Stat informatio nanner a: rkers or ust be vac il warnin ected to l e treated even if th ings cann rnings . age cust 1 or oi g inform

## ENVIRONMENTAL HAZARDS

This pesticide is highly toxic to aquatic invertebrates and wildlife. Birds in treated areas may be killed. Shrimp and other aquatic organisms may be killed at recommended application rates. Do not apply directly to water or wetlands (swamps, bogs and marshes) unless otherwise permitted in Directions for Use. Drift from target areas may be hazardous to aquatic organisms in adjacent aquatic sites.

Do not contaminate water by cleaning of equipment or disposal of wastes.

This product is highly toxic to bees exposed to direct treatment or residues on blooming crops or weeds. Do not apply this product or allow it to drift to blooming crops or weeds if bees are visiting the treatment area.

Under the Endangered Species Act, it is a Federal offense to use any pesticide in a manner that results in the death of a member of an endangered species. Prior to making applications, the user must determine that endangered species are not located in or immediately adjacent to the site to be treated. If the users are unsure whether or not endangered species are located on the site, they should contact the U.S. Fish and Wildlife Service Office (Endangered Specialist) or personnel of the State Fish and Game Office.

This product is designed for use by trained operators and for use by trained operators and for use by trained operators. The hazards are indicated on the label. Do not dilute with water for spray application. Do not use a tank agitator. Thoroughly cover all surfaces. Rates of application given below.

## STORAGE AND DISPOSAL

**PROHIBITIONS:** Do not contaminate water, food, or feed by storage or disposal. Do not store under conditions which might adversely affect the container or its ability to function properly.

**STORAGE:** Do not store below temperature of 0 F. Store in a safe manner. Store in original container. Keep container tightly closed when not in use. Reduce stacking height where local conditions can affect package strength. Personnel should see clothing and equipment listed under "PRECAUTIONARY STATEMENTS" when handling open containers.

**SPILLED MATERIAL:** Block or dike to prevent spreading of spill. Cover with absorbent material such as lime, clay or sawdust. Wash area with strong lye solution, absorb and place in a disposable container.

**PESTICIDE DISPOSAL:** Pesticide wastes are acutely hazardous. Improper disposal of excess pesticide, spray mixture, or rinsate is a violation of Federal Law. If these wastes cannot be disposed of by use according to label instructions, contact your State Pesticide or Environmental Control Agency, or the Hazardous Waste representative at the nearest EPA Regional Office for guidance.

**CONTAINER DISPOSAL:** Metals - Triple rinse (or equivalent). Then offer for recycling or reconditioning, or puncture and dispose of in a sanitary landfill, or by other procedures approved by state and local authorities. Plastic - Triple rinse (or equivalent). Then offer for recycling or reconditioning, or puncture and dispose of in a sanitary landfill, or incinerate.

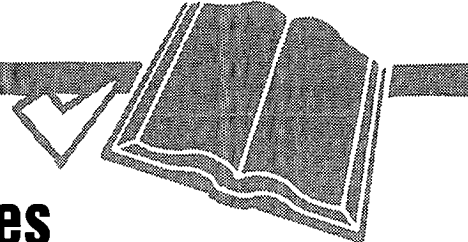
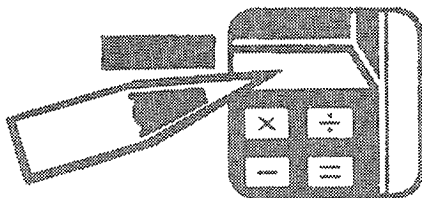

## Learning Objectives

After you complete your study of this module, you should be able to:

- Interpret the terms “label” and “labeling.”
- Identify the meaning of “Restricted Use” classification and explain where to look for it on pesticide labeling.
- Distinguish among the terms “common name,” “chemical

name,” and “brand name” and know which to use to most accurately identify a pesticide product.

- Interpret the signal words (and symbols) on pesticide labeling.
- Know the types of hazard precautionary statements on pesticide labeling.
- Interpret the statement “It is a violation of Federal law to use this

product in a manner inconsistent with its labeling.”

- Explain the pesticide user’s responsibility to follow use directions and requirements contained in separate documents that, although referenced on the labeling, do not necessarily accompany the product at the time of purchase.

## Terms To Know

**Acute effects** — Illnesses or injuries that may appear immediately after exposure to a pesticide (usually within 24 hours).

**Allergic effects** — Harmful effects, such as skin rash or asthma, that some people develop in reaction to pesticides that do not cause the same reaction in most other people.

**Carrier** — The primary material used to allow a pesticide to be dispersed effectively; for example, the talc in a dust formulation, the water mixed with a wettable powder before a spray applica-

tion, or the air that disperses the pesticide in an air blast application.

**Delayed effects** — Illnesses or injuries that do not appear immediately (within 24 hours) after exposure to a pesticide or combination of pesticides.

**Distributor products** — Products that are produced and registered by a manufacturer or formulator and sold under a different name by a distributor.

**Oncogenicity** — The ability to cause tumors.

**Personal protective equipment (PPE)** — Devices and clothing worn to protect the human body from contact with pesticides or pesticide residues.

**Pesticide handler** — Person who directly works with pesticides, such as during mixing, loading, transporting, storing, disposing, and applying, or working on pesticide equipment.

**Precautionary statements** — Pesticide labeling statements that alert you to possible hazards from use of the pesticide product and that sometimes indicate specific actions to take to avoid the hazards.

**Target pest** — The pest toward which control measures are being directed.

**P**esticide product labeling is the main method of communication between a pesticide manufacturer and pesticide users. The information printed on or attached to the pesticide container is the **label**. **Labeling** includes the label itself, plus all other information you receive from the manufacturer about the product when you buy it. The labeling may include brochures, leaflets, and other informa-

tion that accompanies the pesticide product. Pesticide labeling gives you instructions on how to use the product safely and correctly. **Pesticide users are required by law to comply with all the instructions and directions for use in pesticide labeling.**

## EPA Approval of Pesticide Labeling

No pesticide may be sold in the United States until the U.S.

Environmental Protection Agency (EPA) has reviewed the manufacturer's application for registration and determined that the use of the product will not present an unreasonable risk to humans or the environment. As part of this product registration process, EPA has certain labeling information requirements and must approve all language that the manufacturer proposes to include in the product labeling.



United States Environmental Protection Agency  
Pesticides and Toxic Substances (17506C)

### Protecting Endangered Species

201-2055

The information in this pamphlet is similar to what the U.S. Environmental Protection Agency (EPA) expects to distribute once our Endangered Species Protection Program is in effect. The limitations on pesticide use are not law at this time, but are being provided now for your use in voluntarily protecting endangered and threatened species from harm due to pesticide use. We also welcome your comments regarding the Endangered Species Act as intended to protect and promote recovery of animals and plants that are in danger of becoming extinct due to the activities of people. Under the Act, EPA must ensure that use of pesticides it registers will not result in harm to the species listed as endangered or threatened by the U.S. Fish and Wildlife Service, or to habitat critical to those species' survival. To accomplish this, the EPA expects to implement program requirements beginning in 1991. This program will protect endangered and threatened species from harm due to pesticide use. EPA requests your comments regarding the information presented in this publication. Please drop us a line to let us know whether the information is clear and correct. Also tell us to what extent following the recommended measures would affect your typical pesticide use or productivity. This information will be considered by EPA during the final stages of program development.

Please submit comments to:  
Interim Endangered Species Protection Program (17506C)  
Public Docket and Information Section  
U.S. EPA  
401 M Street, SW  
Washington, DC 20460

**201-2055**

**Does This Apply?**  
To determine if this pamphlet applies to your pesticide use, check the following:  
• Do you use the pesticide on a farm?  
• Are you a professional applicator?  
• Do you use the pesticide on a large area?  
• Do you use the pesticide on a large area?  
• Do you use the pesticide on a large area?

**About This Publication**  
This publication contains a County Map showing the area within the county where pesticide use should be limited to protect listed species. These areas are identified on the map by a shaded pattern. Each shaded pattern corresponds to a species in need of protection. The Shading Key shows the name of the species that each shaded pattern represents and describes the shaded area. The first column lists the species, its Range, and Section of the Act. The second column lists the Active Ingredients for which limitations on use are indicated. The next column lists the pattern of the shading key that is necessary to identify the species. The Code indicates the section of the Act that applies to the species.

**RESTRICTED USE PESTICIDE**  
Due to very high toxicity to humans and birds, for those uses covered by the certified applicator's certification.

**VIP DEPESTO I/M**  
Galactothion

**ACTIVE INGREDIENTS:**  
VIP-Diethyl methyl phosphorothioate ..... 21.0%

**INERT INGREDIENTS:**  
..... 79.0%

**TOTAL:**  
..... 100.0%

Contains styrene aromatic solvents.

**KEEP OUT OF REACH OF CHILDREN**

**ANGER PELIGRO**  **POISON**

**STATEMENT OF PRACTICAL TREATMENT**  
Call a doctor (physician), clinic, or hospital immediately. Explain that the victim has been exposed to galactothion and describe his/her condition. If breathing has stopped, start artificial respiration immediately and maintain until a doctor or hospital is reached. Do not induce vomiting or give anything by mouth to an unconscious person. In case of contact, immediately flush the skin with plenty of water while removing contaminated clothing and shoes. See doctor immediately.

**NOTE TO PHYSICIAN**  
Antidote - administer atropine disulfate in large doses. 3mg to 4mg intravenously or intramuscularly as soon as cyanosis is overcome. Repeat at 5 to 10 minute intervals until signs of atropine appear. VIP-Diethyl methyl phosphorothioate is also an antidote and may be administered in conjunction with atropine. **DO NOT GIVE MORPHINE OR TRANQUILIZERS.** Galactothion is a strong cholinesterase inhibitor affecting the central and peripheral nervous system and producing cardiac and respiratory depression. At first signs of pulmonary edema, the patient should be given supplemental oxygen and respiration reported after initial improvement. Continued absorption of the poison may occur and fatal edema have been reported. **FOR AT LEAST 24 HOURS.** VERY CLOSE SUPERVISION OF THE PATIENT IS INDICATED!

**RESTRICTED USE PESTICIDE**

**VIP DEPESTO I/M**  
Galactothion

Emulsifiable Liquid  
An Agricultural Insecticide

**NOT FOR HOME USE**  
Complete Directions for Use  
EPA REG. NO. 34704-10

Use only according to these label instructions.  
© 1984 VIP Chemical Company, Inc. All Rights Reserved.

EPA Registration No. 12345-10  
EPA Establishment No. 56789-CC-3

VIP Chemical Company  
237 South VIP Drive  
Birmingham, MI 22315

Net Contents:  
55 Gallons

EPA reviews the labeling to make sure that it contains all the information needed for safe and effective use of the pesticide product and that the information is backed up by data submitted (or cited) by the manufacturer. EPA may require the manufacturer to change the labeling if it does not contain enough information or if the information is wrong. EPA also may require that the labeling include other information about laws or regulations that have been adopted to protect humans or the environment.

Only after EPA has reviewed the labeling and registered the product can a pesticide product be sold for use. If the manufacturer wants to change the information on the labeling after the product and labeling are registered, EPA must approve the change. EPA also may require changes in labeling.

## Types of Registration

You are responsible for applying only registered pesticides. You may encounter three major types of registration:

- Federal registration,
- special local needs registration,
- emergency exemptions from registration.

**Federal EPA registrations** are the most common. Most pesticide uses are registered this way. Look for the official EPA registration number (which must appear on the label) to be sure you are buying an approved product.

**Special local needs registrations** (known as SLN or 24(c) registrations) allow States to further control how the pesticide is used in their jurisdiction, including registering additional uses or adding limitations for a federally registered pesticide. These registra-

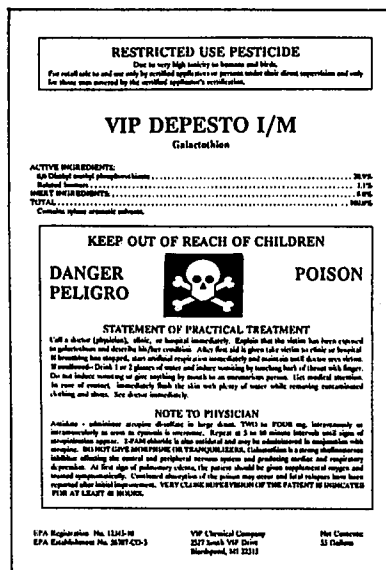

tions often involve adding application sites, pests, or alternate control techniques to those listed on the federally registered labeling.

Supplemental labeling must be provided for each SLN registration. Applicators must have a copy of the SLN labeling in their possession in order to apply the pesticide for that purpose. The registration number of SLN labeling will include the initials "SLN" and the standard two-letter abbreviation code for the State that issued the registration. These registrations are legal only in the State or local area specified in the labeling. Any application in

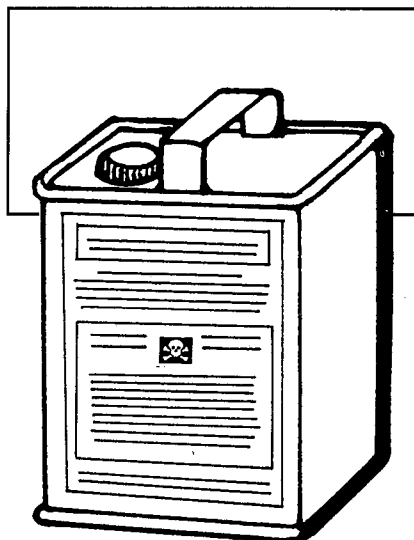

another State or region is subject to civil and criminal penalties. Extension personnel, pesticide dealers, and other professionals will help keep you informed of SLN registrations that pertain to your local area needs.

**Emergency exemptions from registration** are used when an emergency pest situation arises for which no pesticide is registered. If both Federal and SLN registrations would take too long to enact, an emergency registration can be used. Known as "Section 18 exemptions," these registrations are handled by the highest governing official involved — usually a State governor or Federal agency head. This provision allows a pesticide product to be sold and used for a nonregistered purpose for a specified period of time. Strict controls and recordkeeping are required for all these emergency uses. You must understand all of the special requirements and responsibilities involved whenever you use pesticides with emergency exemptions. The agency that has granted the emergency exemption will supply you with the necessary application rates, safety precautions, and other vital information.

## Classification of Pesticide Uses

EPA categorizes every use of every pesticide as either "unclassified" or "restricted use". Many times all the uses of a particular formulation are classified as restricted or all are unclassified. Sometimes, however, certain uses of a formulation are restricted and other uses of the same product are not. In these cases, the directions for use for the two classifications must be clearly separate from one another. Entirely different packaging and labeling are used.



## VIP DEPESTO I/M

Galactothion

### ACTIVE INGREDIENTS:

|   |        |
|---|--------|
| 0,0-Diethyl methyl phosphorothioate ..... | 20.9%  |
| Related Isomers .....                     | 1.1%   |
| INERT INGREDIENTS: .....                  | 8.0%   |
| TOTAL .....                               | 100.0% |

Contains xylene aromatic solvents.

## Restricted-Use Pesticides

A pesticide, or some of its uses, is classified as restricted if it could cause harm to humans (pesticide handlers or other persons) or to the environment unless it is applied by certified applicators who have the knowledge to use these pesticides safely and effectively. The word "use" in this phrase is a general term — it refers to such activities as:

- application,
- mixing and loading,
- transporting, storing, or handling pesticides after the manufacturer's seal is broken,
- care and maintenance of application and handling equipment,
- disposal of pesticides and their containers.

## Certified Pesticide Applicators

Only a certified pesticide applicator may use or supervise the use of restricted-use pesticides. Under Federal law, there are two types of certified pesticide applicators — private applicators and commercial applicators.

**Private applicators** use or supervise the use of restricted-use pesticides to produce an agricultural commodity on property owned or rented by themselves or their employer, or on the property

of another person with whom they trade services.

**Commercial applicators** use or supervise the use of restricted-use pesticides on any property or for any purpose other than that listed for private applicators.

Certification requires training or testing for competency in the safe and effective handling and use of restricted-use pesticides. Your State, tribal, or Federal agency will conduct training and/or testing for certification and may impose stricter standards than those required by Federal law. Many such agencies have agreements to allow certification by one to be accepted by others nearby.

## Parts of Pesticide Labeling

The information on pesticide labeling usually is grouped under headings to make it easier to find the information you need. Some information is required by law to appear on a certain part of the labeling or under certain headings. Other information may be placed wherever the manufacturer chooses.

## Identifying Information

Pesticide labeling contains basic information that helps users clearly identify the product. Some

of these items will be on the front panel of every label, because EPA requires that they appear there. Other items, while generally on the front panel, may be located elsewhere on the label or in the labeling if the manufacturer chooses.

## Brand name

Each manufacturer has a brand name for each of its products. Different manufacturers may use different brand names for the same pesticide active ingredient. Most companies register each brand name as a trademark and do not allow any other company to use that name. The brand or trade name is the one used in advertisements and by company salespeople. The brand name shows up plainly on the front panel of the label.

Pesticide handlers must beware of choosing a pesticide product by brand name alone. Many companies use the same basic name with only minor variations to designate entirely different pesticide chemicals. For example:

- DePesto = carbaryl
- DePesto Super = parathion and methomyl
- DePesto Supreme = carbaryl, parathion, and methomyl

Sometimes several different companies sell the same pesticide product under different brand names. For example:

- De Weed 2E = diquat 2 lbs per gallon EC formulated by Company X
- No Weeds = diquat 2 lbs per gallon EC formulated by Company Z.

Always read the ingredient statement to determine the active ingredients that a product contains.

## Ingredient statement

Each pesticide label must list what is in the product. The list is written so you can readily see what the active ingredients are and the amount of each ingredient (as a percentage of the total product). The ingredient statement must list the official chemical name and/or common name for each active ingredient. Inert ingredients need not be named, but the label must show what percent of the total contents they make up.

The **chemical name** is a complex name that identifies the chemical components and structure of the pesticide. This name is almost always listed in the ingredient statement on the label. For example, the chemical name of Diazinon® is O,O-Diethyl O-(2-isopropyl-4-methyl-6-pyrimidinyl) phosphorothioate.

Because pesticides have complex chemical names, many are given a shorter **common name**. Only common names that are officially accepted by the U. S. Environmental Protection Agency may be used in the ingredient statement on the pesticide label. The official common name may be followed by the chemical name in the list of active ingredients. For example, a label with the brand name Sevin® 50% WP would read:

### Active ingredient:

**Carbaryl (1-naphthyl N-methyl carbamate) ..... 50 %**

**Inert ingredient ..... 50 %**

By purchasing pesticides according to the common or chemical names, you will always be sure to get the right active ingredient.

## Registration and establishment numbers

These numbers are needed by the pesticide handler in case of poisoning, claims of misuse, or liability claims.

An **EPA registration number** (for example, EPA Reg. No. 3120-280-AA) indicates that the pesticide label has been approved by EPA. Most products will contain only two sets of numbers; for example, EPA Reg. No. 3120-280. The first set of numbers, 3120, identifies the manufacturer or company. The second set, 280, identifies the product.

Additional letters and numbers are sometimes part of the EPA registration number; for example, EPA Reg. No. 3120-280-AA-0850. The letters AA might be required by a particular State to appear on that label. The 0850 is the distributor's identification number and appears on labels of distributor products.

When a pesticide is registered by a State because of a special local need, the registration is designated, for example, as EPA SLN No. KS-770009. In this case, SLN indicates "special local need" and KS means that the product is registered for use in Kansas. If the SLN registration is for only a few of the registered uses in the pesticide labeling, the SLN number may not be on the front panel of the pesticide label. Instead, it may be located in the supplementary labeling with the use to which it applies.

The **establishment number** (for example, EPA Est. No. 5840-AZ-I) appears on either the pesticide label or container. It identifies the facility where the product was made. In case there are questions or concerns about the pesticide product, the facility that made the product can be determined.

## Name and address of manufacturer

The law requires the maker or distributor of a product to put the name and address of the company on the label. This is so you will know who made or sold the product.

## Net contents

The front panel of the pesticide label tells you how much is in the container. This can be expressed as pounds or ounces for dry formulations and as gallons, quarts, pints, or fluid ounces for liquids. Liquid formulations also may list the pounds of active ingredient per gallon of product.

## Type of pesticide

The type of pesticide usually is listed on the front panel of the label. This short statement indicates in general terms what the product will control. Examples:

*Insecticide for control of certain insects on fruits, nuts, and ornamentals.*

*Algicide.*

*Herbicide for the control of trees, brush, and weeds.*

## Type of formulation

The front panel of some pesticide labels will tell you what kind of formulation the product is. The formulation may be named or the label may show only an abbreviation, such as WP for wettable powder, D for dust, or EC for emulsifiable concentrate.

## RESTRICTED USE PESTICIDE

Due to very high toxicity to humans and birds.

For retail sale to and use only by certified applicators or persons under their direct supervision and only for those uses covered by the certified applicator's certification.

### Restricted-Use Designation

When a pesticide is classified as restricted, the label will state "Restricted Use Pesticide" in a box at the top of the front panel. Below this heading may be a statement describing the reason for the restricted-use classification. Usually another statement will describe the category of certified applicator who can purchase and use the product. Pesticides that are unclassified have no designation on the product label. Examples of restricted-use statements on pesticide labels include:

**RESTRICTED USE PESTICIDE** due to acute toxicity and toxicity to birds and mammals. For retail sale and use only by certified applicators or persons under their direct supervision and only for those uses covered by the certified applicator's certification.

**RESTRICTED USE PESTICIDE** due to very high acute toxicity to humans and birds. For retail sale to and use only by certified applicators or persons under their direct supervision and only for those uses covered by the certified applicator's certification. Direct supervision for this product is defined as the certified applicator being physically present during application, mixing, loading, repair, and cleaning of application equipment. Commercial certified applicators must also ensure that all persons involved in

*these activities are informed of the precautionary statements.*

**RESTRICTED USE PESTICIDE** due to oncogenicity. For retail sale and use only by certified applicators or persons under their direct supervision and only for those uses covered by the certified applicator's certification. The use of this product may be hazardous to your health. This product contains [active ingredient], which has been determined to cause tumors in laboratory animals.

**RESTRICTED USE PESTICIDE** due to ground water concern. For retail sale to and use only by certified applicators or persons under their direct supervision and only for those uses covered by the certified applicators' certification. Users must read and follow all precautionary statements and instructions for use in order to minimize potential of [active ingredient] to reach ground water.

### Front-Panel Precautionary Statements

#### Signal words and symbols

The signal word — DANGER, WARNING, or CAUTION — must appear in large letters on the front panel of the pesticide label. It indicates how acutely toxic the product is to humans. The signal word is immediately below the statement, "Keep out of reach of children," which also must appear on every label.

The signal word is based not on the active ingredient alone, but on the contents of the formulated product. It reflects the hazard of any active ingredients, carriers, solvents, or inert ingredients. The signal word indicates the risk of acute effects from the four routes of exposure to a pesticide product (oral, dermal, inhalation, and eye) and is based on the one that is greatest. The signal word does not indicate the risk of delayed effects or allergic effects.

Use the signal word to help you decide what precautionary measures are needed for yourself, your workers, and other persons (or animals) that may be exposed.

■ **DANGER** — This word signals you that the pesticide is highly toxic. The product is very likely to cause acute illness from oral, dermal, or inhalation exposure, or to cause severe eye or skin irritation.

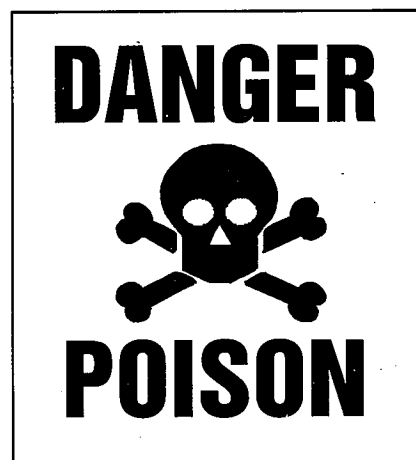

■ **POISON/SKULL AND CROSSBONES** — All highly toxic pesticides that are very likely to cause acute illness through oral, dermal, or inhalation exposure

also will carry the word POISON printed in red and the skull and crossbones symbol. Products that have the signal word DANGER due to skin and eye irritation potential will not carry the word POISON or the skull and crossbones symbol.

■ **WARNING** — This word signals you that the product is moderately likely to cause acute illness from oral, dermal, or inhalation exposure or that the product is likely to cause moderate skin or eye irritation.

■ **CAUTION** — This word signals you that the product is slightly toxic or relatively nontoxic. The product has only slight potential to cause acute illness from oral, dermal, or inhalation exposure. The skin or eye irritation it would cause, if any, is likely to be slight.

### Statement of practical treatment (first aid)

Most pesticide products are required to include instructions on how to respond to an emergency exposure involving that product. The instructions usually include first aid measures and may include instructions to seek medical help. If the Statement of Practical Treatment is not located on the front panel, a statement on the front panel must refer the user to the section of the label or labeling where the Statement of Practical Treatment may be found.

### Hazards to Humans and Domestic Animals

#### Acute effects statements

The label or labeling will contain statements that indicate which route of entry (mouth skin, eyes, lungs) you must particularly protect and what specific action you need to take to avoid acute

### STATEMENT OF PRACTICAL TREATMENT

Call a doctor (physician), clinic, or hospital immediately. Explain that the victim has been exposed to galactothion and describe his/her condition. After first aid is given take victim to clinic or hospital.

effects from exposure to the pesticide. These statements may be on the front or side panel of the label, or they may be located somewhere else in the labeling. The statements will warn you if you may be harmed by swallowing or inhaling the product or getting it on your skin or in your eyes.

Many pesticides can cause acute effects by more than one route, so study these statements carefully. These precautionary statements tell you what parts of your body will need the most protection. "DANGER: Fatal if swallowed or inhaled" gives a far different indication than "DANGER: Corrosive — causes eye damage and severe skin burns."

### PRECAUTIONARY STATEMENTS

#### HAZARDS TO HUMANS (& DOMESTIC ANIMALS)

##### DANGER:

Fatal if absorbed through the skin, fatal if swallowed, and poisonous if inhaled. Do not breathe vapors or spray mist. Do not get on skin or clothing.

#### Delayed effects statements

The labeling of pesticides that the Environmental Protection Agency considers to have the potential to cause delayed effects must warn you of that fact. These statements will tell you whether the product has been shown to cause problems such as tumors or reproductive problems in laboratory animals.

#### Allergic effects statement

If tests or other data indicate that the pesticide product has the potential to cause allergic effects, such as skin irritation or asthma, the product labeling must state that fact. Sometimes the labeling refers to allergic effects as "sensitization."

#### Personal protective equipment statements

Immediately following the statements about acute, delayed, and allergic effects, the labeling usually lists personal protective equipment requirements. These statements tell you the **minimum** personal protective equipment that you must wear when using the pesticide. Sometimes the statements will require different

### PERSONAL PROTECTIVE EQUIPMENT

Applicators and other handlers must wear:

Coveralls over long-sleeved shirt and long-legged pants

Chemical-resistant gloves such as butyl or nitrile

Chemical-resistant footwear plus socks

Eye protection

Respirator with an organic vapor-removing cartridge and a prefilter approved for pesticides — MSHA/NIOSH approval prefix (23C) or canister approved for pesticides — MSHA/NIOSH approval number (14G)

Overhead applications: add chemical-resistant wide-brimmed hat or hood

Mixers/loaders and cleaners of equipment: add chemical-resistant apron

- use any appropriate equipment or method of application that is not prohibited by the labeling,
- mix a pesticide or pesticides with a fertilizer if the mixture is not prohibited by the labeling,
- mix two or more pesticides, if all of the dosages are at or below the recommended rate.

### Entry statement

Some pesticide labeling contains a precaution about entering a treated area after application. This statement tells you how much time must pass before people can enter a treated area except under special circumstances. These entry intervals are set by both EPA and some States. Entry intervals set by States are not always listed on the label; it is your responsibility to determine whether one has been set.

The entry statement may be printed in a box under the heading "Entry" or "Worker Protections," or it may be in a section with a title such as "Important," "Note," or "General Information." If the entry interval applies only to certain uses or locations, the heading may indicate that limitation. For example, the heading might be "Agricultural Use Restrictions."

### Storage and disposal

All pesticide labeling contains some instructions for storing the pesticide. These may include both general statements, such as "Keep out of reach of children and pets," and specific directions, such as "Do not store in temperatures below 32 °F."

Pesticide labeling also contains some general information about how to dispose of excess pesticide and the pesticide container in ways that are acceptable under Federal regulations. State and

## STORAGE AND DISPOSAL

**PROHIBITIONS:** Do not contaminate water, food, or feed by storage or disposal. Do not store under conditions which might adversely affect the container or its ability to function properly.

**STORAGE:** Do not store below temperature of 0 °F. Store in a safe manner. Store in original container only. Keep container tightly closed when not in use. Reduce stacking height where local conditions can affect package strength. Personnel should see clothing and equipment listed under "PRECAUTIONARY STATEMENTS" when handling open containers.

**SPILLED MATERIAL:** Block or dike to prevent spreading of spill. Cover with absorbent material such as lime, clay, or sawdust. Wash area with strong lye solution, absorb, and place in a disposable container.

**PESTICIDE DISPOSAL:** Pesticide wastes are acutely hazardous. Improper disposal of excess pesticide, spray mixture, or rinsate is a violation of Federal law. If these wastes cannot be disposed of by use according to label instructions, contact your State Pesticide or Environmental Control Agency, or the Hazardous Wastes representative at the nearest EPA Regional Office for guidance.

**CONTAINER DISPOSAL:**  
**Metals** — Triple rinse (or equivalent). Then offer for recycling or reconditioning, or puncture and dispose of in a sanitary landfill, or by other procedures approved by State and local authorities.  
**Plastics** — Triple rinse (or equivalent). Then offer for recycling or reconditioning, or puncture and dispose of in a sanitary landfill, or incinerate.

local laws vary, however, so the labeling usually does not give exact disposal instructions.

Storage and disposal statements usually appear in a special section of the labeling titled "Storage and Disposal."

### Other directions for use

The instructions on how to use the pesticide are an important part of the labeling. This is the best way you can find out the right way to handle the product.

The use instructions will tell you:

- the pests that the manufacturer claims the product will control,
- the plant, animal, or site the product is intended to protect,
- in what form the product should be applied,
- the correct equipment to use,
- how much pesticide to use,
- mixing directions,
- whether the product can be mixed with other often-used products,
- whether the product is likely to cause unwanted injuries or stains to plants, animals, or surfaces,
- where the material should be applied,
- when and how often it should be applied.

### Directions for use by reference

Some directions for use that pesticide users must obey are contained in documents that are only **referred to** on the product labeling. Such instructions include EPA or other Government agency regulations or requirements concerning the safe use of the pesticide product. For example, a pesticide label might state:

*Use of this product in a manner inconsistent with the PESTICIDE USE BULLETIN FOR PROTECTION OF ENDANGERED SPECIES is a violation of Federal laws. Restrictions for the protection of endangered species apply to this product. If restrictions apply to the area in which this product is to be used, you must obtain the PESTICIDE USE*



personal protective equipment for different pesticide handling activities. For example, an apron may be required only during mixing and loading or equipment cleaning. Sometimes the statements will allow reduced personal protective equipment when you use safety systems, such as closed systems or enclosed cabs.

## Environmental Hazards

This section of the pesticide labeling will indicate precautions for protecting the environment when you use the pesticide. Some general statements appear on the labeling of nearly every pesticide.

### ENVIRONMENTAL HAZARDS

This pesticide is highly toxic to aquatic invertebrates and wildlife. Birds in treated areas may be killed.

Do not contaminate water by cleaning of equipment or disposal of wastes.

This product is highly toxic to bees exposed to direct treatment or residues on blooming crops or weeds. Do not apply this product or allow it to drift to blooming crops or weeds if bees are visiting the treatment area.

Most pesticide labeling, for example, will warn you not to contaminate water when you apply the pesticide or when you clean your equipment or dispose of pesticide wastes. The labeling will contain specific precautionary statements if the pesticide poses a specific hazard to the environment. For example, it may warn you that the product is highly toxic to bees or other wildlife.

## Physical or Chemical Hazards

This section of the pesticide labeling will tell you of any special fire, explosion, or chemical hazards the product may pose. For example, it will alert you if the product is so flammable that you need to be especially careful to keep it away from heat or open flame or if it is so corrosive that it must be stored in a corrosion-resistant container. When pesticides are flammable, smoking while handling them is extremely hazardous.

**Note:** The physical or chemical hazard statements are not located in the same place in all pesticide labeling. Some labeling groups them in a box under the heading "Physical or Chemical Hazards." Other labeling may list them on the front panel of the label beneath the signal word. Still other labeling may list the hazards in paragraph form under headings such as "Note" or "Important." If there are no unusual physical or chemical hazards, there may be no statement in the labeling.

## Directions for Use

Directly under the heading "Directions for Use" on every pesticide product labeling is the following statement: "It is a violation of Federal law to use this product in a manner inconsistent with its labeling." The Directions for Use section also contains sections on storage and disposal and may contain a section on entry

### DIRECTIONS FOR USE

It is a violation of Federal law to use this product in a manner inconsistent with its labeling.

### PHYSICAL AND CHEMICAL HAZARDS

Do not use or store near heat or open flame. Not for use or storage in or around the home.

into treated areas after a pesticide application. In addition, the Directions for Use section will contain the specific directions for using the product.

## Use inconsistent with the labeling

It is illegal to use a pesticide in any way not permitted by the labeling. A pesticide may be used only on the plants, animals, or sites named in the directions for use. You may not use higher dosages, higher concentrations, or more frequent applications. You must follow all directions for use, including directions concerning safety, mixing, diluting, storage, and disposal. You must wear the specified personal protective equipment even though you may be risking only your own safety by not wearing it. **The use directions and instructions are not advice, they are requirements.**

Federal law **does** allow you to use pesticides in some ways not specifically mentioned in the labeling. Unless you would be in violation of the laws of your State or tribe, you may:

- apply a pesticide at any dosage, concentration, or frequency **less** than that listed on the labeling,
- apply a pesticide against any target pest not listed on the labeling if the application is to a plant, animal, or site that is listed,

*BULLETIN FOR PROTECTION  
OF ENDANGERED SPECIES for  
that county.*

This statement probably would be the only indication on the pesticide label or in the labeling that other use directions and restrictions apply to the product.

**You are responsible** for determining whether the regulation, bulletin, or other document referred to on the pesticide product labeling applies to your situation and your intended use of the pesticide product. If the document is applicable, you must comply with all the specific directions for use and other requirements that it contains. These documents do not always accompany the pesticide product when it is sold. Instead, you may have to get the additional directions and requirements from other sources, such as pesticide dealers

or company representatives, industry or commodity organizations, land-grant universities, or Cooperative Extension agents.

This reference to other documents is a new practice. It is necessary because there is no longer room on the traditional pesticide label to explain the requirements of all laws and regulations that may apply to the user. For example, EPA has adopted or is considering new requirements concerning:

- ground water protection,
- endangered species protection,
- pesticide transportation, storage, and disposal, and
- worker protection.

Some of these are general use directions that apply to all pesticides, so one copy should be sufficient for each affected user. In other cases, the instructions and restrictions apply only in certain geographical areas or to certain uses of a pesticide product. Copies

of the directions for use that are applicable in the specific situation need to be distributed only to the affected users.

The decision by EPA not to require all of the applicable directions for use to be distributed with each pesticide product places greater responsibility on the pesticide user. One sentence or paragraph on a pesticide label may be the only notice you will receive that additional use directions are required in order for the product to be used in compliance with its labeling. You must:

- determine whether you are affected,
- locate the applicable directions for use,
- determine how to comply with the instructions and requirements in the directions for use, and
- comply with those instructions and requirements.



## Know the Law

A law passed by Congress in 1947 and substantially amended in 1972, 1975, 1978, and 1988 regulates the registration, manufacture, sale, transportation, and use of pesticides. The Federal Insecticide, Fungicide, and Rodenticide Act is commonly referred to by its initials — FIFRA.

FIFRA affects certified applicators in many ways. For example, it provides that:

- EPA must register pesticides and pesticide uses.
- All pesticides must be used only as directed on the labeling.
- EPA must classify as “restricted use” those uses of pesti-

cides that may cause unreasonable adverse effects to the environment, including humans, even when used as directed on the product labeling.

- Persons who buy or use restricted-use pesticides must be certified as competent pesticide applicators or must be directly supervised by a certified applicator.
- States may establish stricter standards governing pesticides, but not more permissive standards.
- Persons who use pesticides in a way that is “inconsistent with the pesticide labeling” are subject to penalties.

If you violate FIFRA, or regulations issued under it, you are subject to civil penalties. They can be as much as \$5,000 for each offense (\$1,000 for private applicators). Before EPA can fine you, you have the right to ask for a hearing in your own city or county. Some violations of the law also may subject you to criminal penalties. These can be as much as \$25,000 or 1 year in prison, or both, for commercial applicators; \$1,000 and/or 30 days in prison for private applicators. States may establish higher penalties.

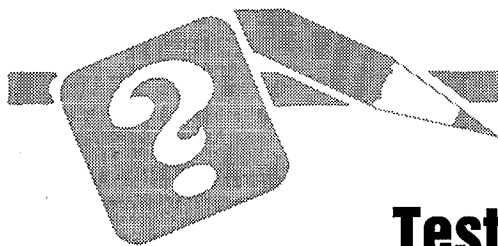

## Test Your Knowledge

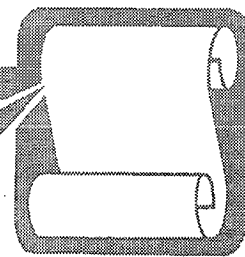

**Q.** Explain the differences between the terms “label” and “labeling.”

**A.** The label is the information printed on or attached to the pesticide container. Labeling includes the label itself, plus all other information you receive from the manufacturer about the product when you buy it.

**Q.** What do the words “Restricted Use Pesticide” tell you about the pesticide product?

**A.** “Restricted Use Pesticide” means that the product has been shown to be likely to harm people or the environment if it is not used correctly. It may be purchased and used only by certified applicators and those under their direct supervision.

**Q.** Where would you look to find out whether a pesticide is classified as Restricted Use?

**A.** If a pesticide is classified as Restricted Use, the words “Re-

stricted Use Pesticide” will appear in a box on the front panel of the pesticide label.

**Q.** Explain the differences between chemical name, common name, and brand name. Which of these terms should you use to most accurately identify a pesticide product?

**A.** The chemical name is a complex name that identifies the chemical components and structure of the pesticide. A common



name is a shorter name that EPA recognizes as a substitute for the chemical name of a product. A brand name is the name — usually a trademark — used by a chemical company to identify a pesticide product. The common name (or the chemical name, if no common name is given) is the most accurate and useful way to identify a pesticide product.

**Q. Name and explain the meaning of the signal words and symbols you may see on a pesticide product.**

**A.** “Caution” indicates that the pesticide product is slightly toxic or relatively nontoxic. “Warning” indicates that the pesticide product is moderately toxic. “Danger” indicates that the pesticide product is highly toxic. “Poison” and the skull and crossbones indicates that the pesticide product is highly toxic as a poison, rather than as a skin or eye irritant.

**Q. Can you use the signal word on a pesticide label to judge the likelihood of suffering acute, delayed, or allergic effects if you are overexposed to the product? Explain.**

**A.** Signal words and symbols indicate the likelihood that you will experience **acute** harmful effects if you are over-exposed. Signal words **do not** tell you anything about the risks of delayed harmful effects or allergic effects.

**Q. What types of hazard statements should you look for in the pesticide labeling?**

**A.** You should look for precautions about hazards to humans (and domestic animals), environmental hazards, and physical/chemical hazards.

**Q. What types of precautionary statements may be included in the labeling section titled “Hazards to Humans”?**

**A.** Acute effects precautions, delayed effects precautions, allergic effect precautions, and personal protective equipment requirements may be in the section of the labeling titled “Hazards to Humans.”

**Q. What is the meaning of the statement: “It is a violation of Federal law to use this product in a manner inconsistent with its labeling”?**

**A.** It is illegal to use a pesticide in any way not permitted by the labeling. A pesticide may be used only on the plants, animals, or sites named in the directions for use. You may not use higher dosages, higher concentrations, or more frequent applications. You must follow all directions for use, including directions concerning safety, mixing, diluting, storage, and disposal. You must wear the specified personal protective equipment even though you may be risking only your own safety by not wearing it.

**Q. Does the pesticide label contain all the instructions and directions for use that you need to use the product safely and legally?**

**A.** Some pesticide products have all the necessary instructions and directions for use on the product label. For other products, more instructions and directions may be in other labeling that accompanies the product at the time of purchase. The label or labeling of still other products may refer to separate documents that contain specialized instructions and directions. Pesticide users are required by law to comply with all these types of instructions and directions — not just with the label itself.



---

# Formulations

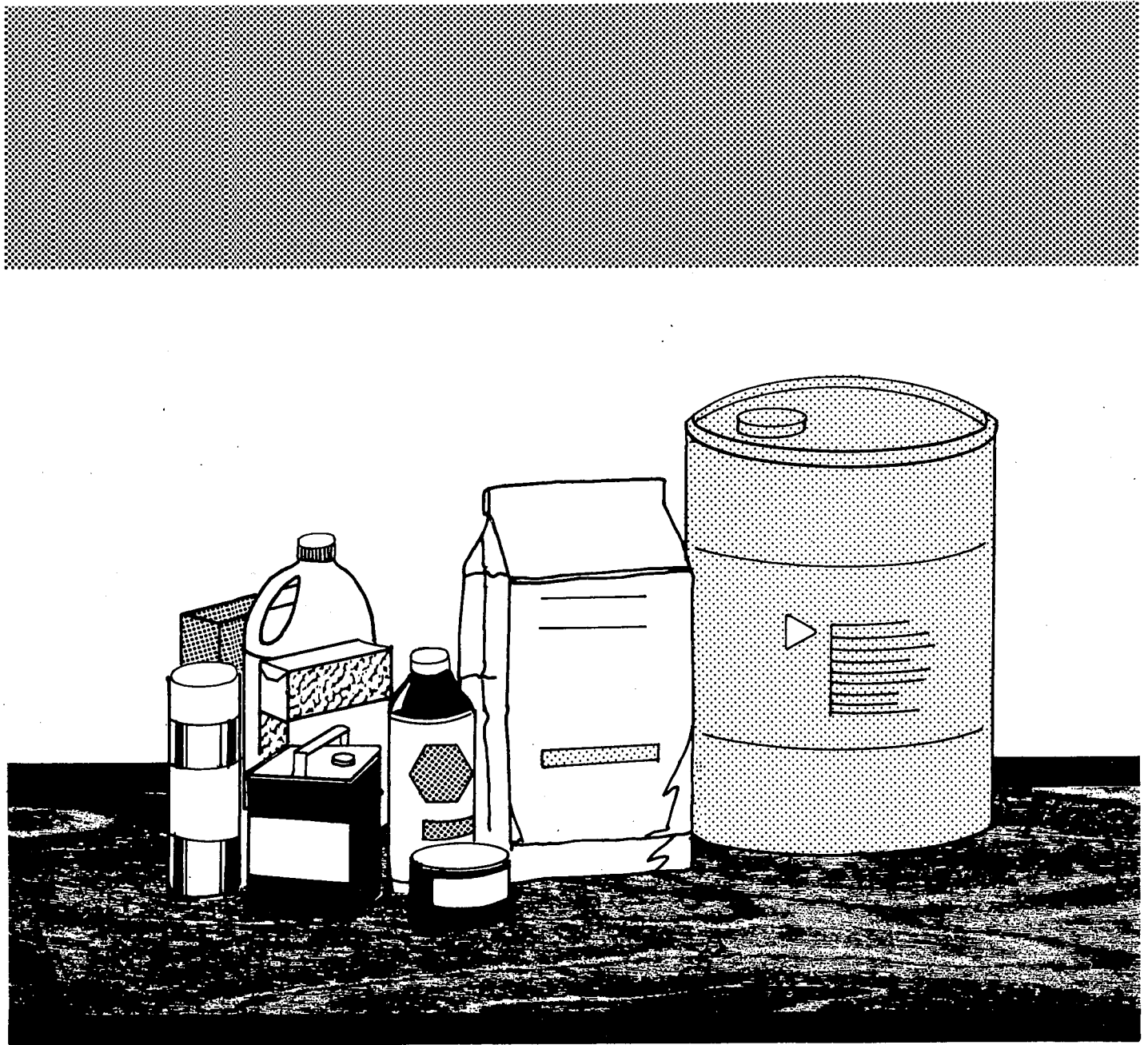

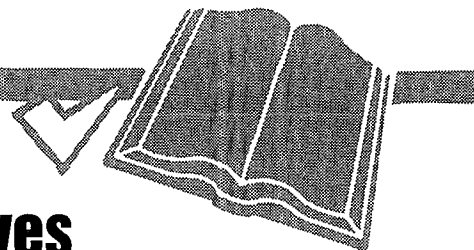
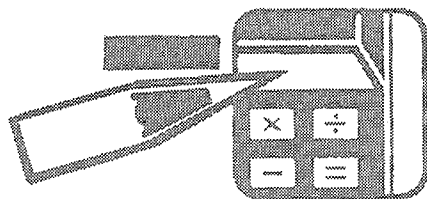

## Learning Objectives

After you complete your study of this unit, you should be able to:

- Explain what a pesticide formulation is.
- Distinguish between “active” and “inert” ingredients.

- Identify factors to consider when choosing a formulation.
- Use your knowledge of the characteristics, advantages, and disadvantages of different types of pesticide formulations to select

- appropriate formulations for specific purposes.
- Recognize the purpose of adjuvants and list several types.

## Terms To Know

**Abrasive** — Capable of wearing away or grinding down another object.

**Agitation** — The process of stirring or mixing.

**Alkaline** — The opposite of acidic; having a pH greater than 7.

**Carrier** — The primary material used to allow a pesticide to be dispersed effectively; for example, the talc in a dust formulation, the water mixed with a wettable powder before a spray application, or the air that disperses the pesticide in an air blast application.

**Dilute** — To make less concentrated.

**Emulsion** — A mixture of two or more liquids that are not soluble in one another. One is suspended as small droplets in the other.

**Insoluble** — Does not dissolve in liquid.

**Nontarget** — Any site or organism other than the site or pest toward which the control measures are being directed.

**Pesticide handler** — Person who directly works with pesticides, such as during mixing, loading, transporting, storing, disposing, and applying, or working on pesticide equipment.

**Petroleum-based** — Made from petroleum products. Examples are: xylene, refined oil, and kerosene.

**Soluble** — Able to be dissolved in another substance, usually a liquid.

**Solvent** — A liquid, such as water, kerosene, xylene, or alcohol, that will dissolve a pesticide (or other substance) to form a solution.

**Suspension** — A substance that contains undissolved particles mixed throughout a liquid.

**Target pest** — The pest toward which control measures are being directed.

**Volatile** — Evaporating rapidly; turning easily into a gas or vapor.

**T**he active ingredients in a pesticide are the chemicals that control the target pest. Most pesticide products you buy also have other ingredients, called inert (inactive) ingredients. They are used to dilute the pesticide or to make it safer, more effective, easier to measure, mix, and apply, and more convenient to handle.

Usually the pesticide is diluted in water, a petroleum-based solvent, or another diluent. Other chemicals in the product may include wetting agents, spreaders, stickers, or extenders. This mixture of active and inert ingredients is called a pesticide formulation.

Some formulations are ready for use. Others must be further diluted with water, a petroleum-based solvent, or air (as in airblast or ULV applications) by the user before they are applied.

A single active ingredient often is sold in several different kinds of formulations. If you find that more than one formulation is available for your pest control situation, you must choose the best one for the job. Before you make the choice, ask yourself several questions

about each formulation. For example:

- Do you have the necessary application equipment?
- Can the formulation be applied safely under the conditions in the application area?
- Will the formulation reach your target and stay in place long enough to control the pest?
- Is the formulation likely to harm the surface to which you will apply it?

To answer these kinds of questions, you need to know something about the characteristics of different types of formulations and the general advantages and disadvantages of each type.

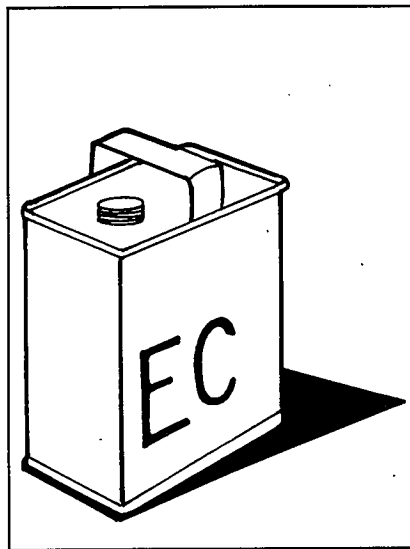

## Liquid Formulations

### Emulsifiable Concentrates (EC or E)

An emulsifiable concentrate formulation usually contains liquid active ingredient, one or more petroleum-based solvents, and an agent that allows the formulation to be mixed with water to form an emulsion. Each gallon of EC usually contains 25 to 75 percent (2 to 8 pounds) active ingredient. EC's are among the most versatile formulations. They are used against agricultural, ornamental and turf, forestry, structural, food processing, livestock, and public health pests. They are adaptable to many types of application equipment, from small, portable sprayers to hydraulic sprayers, low-volume ground sprayers, mist blowers, and low-volume aircraft sprayers.

#### Advantages:

- Relatively easy to handle, transport, and store,
- Little agitation required — will not settle out or separate when equipment is running,
- Not abrasive,
- Do not plug screens or nozzles,
- Little visible residue on treated surfaces.

### Disadvantages:

- High concentration makes it easy to overdose or underdose through mixing or calibration errors,
- May cause unwanted harm to plants,
- Easily absorbed through skin of humans or animals,
- Solvents may cause rubber or plastic hoses, gaskets, and pump parts and surfaces to deteriorate,
- May cause pitting or discoloration of painted finishes,
- Flammable — should be used and stored away from heat or open flame,
- May be corrosive.

### Solutions (S)

Some pesticide active ingredients dissolve readily in a liquid solvent, such as water or a petroleum-based solvent. When mixed with the solvent, they form a solution that will not settle out or separate. Formulations of these pesticides usually contain the active ingredient, the solvent, and one or more other ingredients. Solutions may be used in any type of sprayer indoors or outdoors.

### Ready-to-use (RTU)

Some solutions are products that contain the correct amount of solvent when you buy them. No further dilution is required before application. These formulations, usually solutions in petroleum-based solvents, contain small amounts (often 1 percent or less) of active ingredient per gallon.

### Concentrate solutions (C or LC)

Other solutions are sold as concentrates that must be further diluted with a liquid solvent before you apply them. Occasionally the solvent is water, but more often the solvent is a specially

refined oil or petroleum-based solvent.

Some uses of solutions are:

- structural and institutional pest control,
- control of some household pests,
- livestock and poultry pest control,
- space sprays in barns and warehouses,
- shade tree pest control,

- mosquito control.

### Advantages:

- No agitation necessary.

### Disadvantages:

- Limited number of formulations of this type available.

The other advantages and disadvantages of solutions vary depending on the solvent used, the concentration of the active ingredient, and the type of application involved.

## Abbreviations for Formulations

|     |   |  |
|-----|---|--|
| A   | = | Aerosol                                |
| AF  | = | Aqueous Flowable                       |
| AS  | = | Aqueous Solution or Aqueous Suspension |
| B   | = | Bait                                   |
| C   | = | Concentrate                            |
| CM  | = | Concentrate Mixture                    |
| CG  | = | Concentrate Granules                   |
| D   | = | Dust                                   |
| DF  | = | Dry Flowable                           |
| DS  | = | Soluble Dust                           |
| E   | = | Emulsifiable Concentrate               |
| EC  | = | Emulsifiable Concentrate               |
| F   | = | Flowable                               |
| G   | = | Granules                               |
| H/A | = | Harvest Aid                            |
| L   | = | Flowable                               |
| LC  | = | Liquid Concentrate or Low Concentrate  |
| LV  | = | Low Volatile                           |
| M   | = | Microencapsulated                      |
| MTF | = | Multiple Temperature Formulation       |
| P   | = | Pellets                                |
| PS  | = | Pellets                                |
| RTU | = | Ready to Use                           |
| S   | = | Solution                               |
| SD  | = | Soluble Dust                           |
| SG  | = | Soluble Granule                        |
| SP  | = | Soluble Powder                         |
| ULV | = | Ultra Low Volume                       |
| ULW | = | Ultra Low Weight or Ultra Low Wettable |
| WS  | = | Water Soluble                          |
| WSG | = | Water-Soluble Granules                 |
| WSL | = | Water-Soluble Liquid                   |
| W   | = | Wettable Powder                        |
| WDG | = | Water-Dispersible Granules             |
| WP  | = | Wettable Powder                        |
| WSP | = | Soluble Powder                         |

## Ultra-Low-Volume (ULV)

These concentrates may approach 100 percent active ingredient. They are designed to be used as is or to be diluted with only small quantities of specified solvents. These special-purpose formulations are used mostly in outdoor applications, such as in agricultural, forestry, ornamental, and mosquito control programs.

### Advantages:

- Relatively easy to handle, transport, and store,
- Little agitation required,
- Not abrasive to equipment,
- No plugging of screens and nozzles,
- Little visible residue on treated surfaces.

### Disadvantages:

- Difficult to keep pesticide in the target site — high drift hazard,
- Specialized equipment required,
- Easily absorbed through skin of humans or animals,
- Solvents may cause rubber or plastic hoses, gaskets, and pump parts and surfaces to deteriorate.

## Flowables (F or L)

Some active ingredients are insoluble solids. These may be formulated as flowables in which the finely ground active ingredients are mixed with a liquid, along with inert ingredients, to form a suspension. Flowables are mixed with water for application and are similar to EC or wettable powder formulations in ease of handling and use. They are used in the same types of pest control operations for which EC's are used.

### Advantages:

- Seldom clog nozzles,
- Easy to handle and apply.

### Disadvantages:

- Require moderate agitation,
- May leave a visible residue.

## Aerosols (A)

These formulations contain one or more active ingredients and a solvent. Most aerosols contain a low percentage of active ingredient. There are two types of aerosol formulations — the ready-to-use type, and those made for use in smoke or fog generators.

### Ready-to-use aerosols

These aerosol formulations are usually small, self-contained units that release the pesticide when the nozzle valve is triggered. The pesticide is driven through a fine opening by an inert gas under pressure, creating fine droplets. These products are used in greenhouses, in small areas inside buildings, or in localized outdoor areas. Commercial models, which hold 5 to 10 pounds of pesticide, are usually refillable.

### Advantages:

- Ready to use,
- Easily stored,
- Convenient way to buy small amount of a pesticide,
- Retain potency over fairly long time.

### Disadvantages:

- Practical for very limited uses,
- Risk of inhalation injury,
- Hazardous if punctured, overheated, or used near an open flame,
- Difficult to confine to target site or pest.

### Formulations for smoke or fog generators

These aerosol formulations are not under pressure. They are used in machines that break the liquid formulation into a fine mist or fog (aerosol) using a rapidly whirling disk or heated surface. These formulations are used mainly for insect control in structures such as greenhouses and warehouses and

for mosquito and biting fly control outdoors.

### Advantages:

- Easy way to fill entire space with pesticide.

### Disadvantages:

- Highly specialized use and equipment,
- Difficult to confine to target site or pest,
- May require respiratory protection to prevent risk of inhalation injury.

## Invert Emulsions

This mixture contains a water-soluble pesticide dispersed in an oil carrier. Invert emulsions require a special kind of emulsifier that allows the pesticide to be mixed with a large volume of petroleum-based carrier, usually fuel oil. When applied, invert emulsions form large droplets that do not drift easily. Invert emulsions are most commonly used in vegetation control along rights-of-way where drift to susceptible nontarget plants is a problem.

## Dry Formulations

### Dusts (D)

Most dust formulations are ready to use and contain a low percentage of active ingredient (usually 1/2 to 10 percent), plus a very fine dry inert carrier made from talc, chalk, clay, nut hulls, or volcanic ash. The size of individual dust particles is variable.

A few dust formulations are concentrates and contain a high percentage of active ingredient. These must be mixed with dry inert carriers before they can be applied.

Dusts are always used dry, and they easily drift into nontarget sites. They sometimes are used for agricultural applications. In structures, dust formulations are

used in cracks and crevices and for spot treatments. They are widely used in seed treatment. Dusts also are used to control lice, fleas, and other parasites on pets and live-stock.

**Advantages:**

- Usually ready to use, with no mixing,
- Effective where moisture from a spray might cause damage,
- Require simple equipment,
- Effective in hard-to-reach indoor areas.

**Disadvantages:**

- Easily drift off target during application,
- Residue easily moved off target by air movement or water,
- May irritate eyes, nose, throat, and skin,
- Do not stick to surfaces as well as liquids,
- Difficult to get an even distribution of particles on surfaces.

### Baits (B)

A bait formulation is an active ingredient mixed with food or another attractive substance. The bait either attracts the pests or is placed where the pests will find it. Pests are killed by eating the pesticide the bait contains. The amount of active ingredient in most bait formulations is quite low, usually less than 5 percent.

Baits are used inside buildings to control ants, roaches, flies, and other insects and for rodent control. Outdoors they sometimes are used to control snails, slugs, and some insects, but their main use is for control of vertebrate pests such as rodents, other mammals, and birds.

**Advantages:**

- Ready to use,
- Entire area need not be covered, because pest goes to bait,
- Control pests that move in and out of an area.

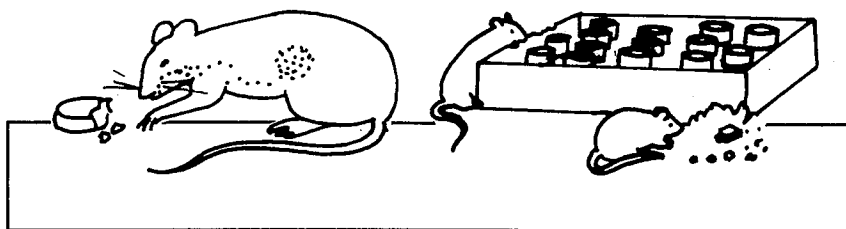

**Disadvantages:**

- Can be attractive to children and pets,
- May kill domestic animals and nontarget wildlife outdoors,
- Pest may prefer the crop or other food to the bait,
- Dead pests may cause odor problem,
- Other animals may be poisoned as a result of feeding on the poisoned pests.
- If baits are not removed when the pesticide becomes ineffective, they may serve as a food supply for the target pest or other pests.

### Granules (G)

Granular formulations are similar to dust formulations except that granular particles are larger and heavier. The coarse particles are made from an absorptive material such as clay, corn cobs, or walnut shells. The active ingredient either coats the outside of the granules or is absorbed into them. The amount of active ingredient is relatively low, usually ranging from 1 to 15 percent.

Granular pesticides are most often used to apply chemicals to the soil to control weeds, nematodes, and insects living in the soil. Granular formulations are sometimes used in airplane or helicopter applications to minimize drift or to penetrate dense vegetation.

Granular formulations also are used to control larval mosquitoes

and other aquatic pests. Granules are used in agricultural, structural, ornamental, turf, aquatic, right-of-way, and public health (biting insect) pest control operations.

**Advantages:**

- Ready to use — no mixing,
- Drift hazard is low, and particles settle quickly,
- Little hazard to applicator — no spray, little dust,
- Weight carries the formulation through foliage to soil or water target,
- Simple application equipment, such as seeders or fertilizer spreaders,
- May break down more slowly than WP's or EC's through a slow-release coating.

**Disadvantages:**

- Do not stick to foliage or other nonlevel surfaces,
- May need to be incorporated into soil or planting medium,
- May need moisture to start pesticidal action,
- May be hazardous to nontarget species, especially waterfowl and other birds that mistakenly feed on the grain- or seed-like granules.

### Pellets (P or PS)

Most pellet formulations are very similar to granular formulations; the terms often are used interchangeably. In a pellet formulation, however, all the particles are the same weight and shape. The uniformity of the particles allows them to be applied by precision applicators such as



those being used for precision planting of pelleted seed. A few fumigants are formulated as pellets; however, these will be clearly labeled as fumigants and should not be confused with nonfumigant, granule-like pellets.

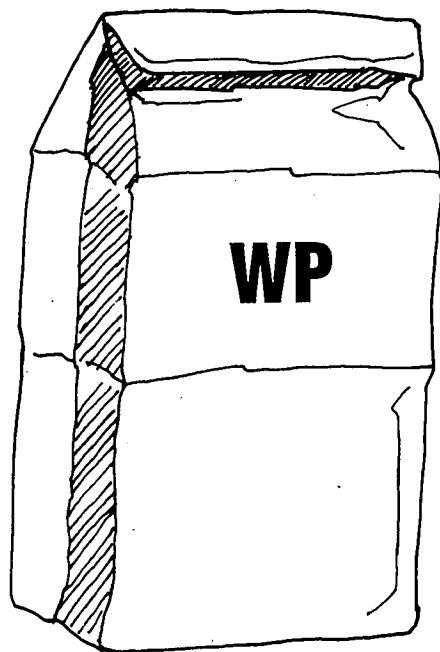

### **Wettable Powders (WP or W)**

Wettable powders are dry, finely ground formulations that look like dusts. They usually must be mixed with water for application as a spray. A few products, however, may be applied either as a dust or as a wettable powder — the choice is left to the applicator.

Wettable powders contain 5 to 95 percent active ingredient, usually 50 percent or more. Wettable powder particles do not dissolve in water. They settle out quickly unless constant agitation is used to keep them suspended.

Wettable powders are one of the most widely used pesticide formulations. They can be used for most pest problems and in most types of spray equipment where agitation is possible.

#### **Advantages:**

- Easy to store, transport, and handle,
- Less likely than EC's and other petroleum-based pesticides to cause unwanted harm to treated plants, animals, and surfaces,
- Easily measured and mixed,
- Less skin and eye absorption than EC's and other liquid formulations.

#### **Disadvantages:**

- Inhalation hazard to applicator while pouring and mixing the concentrated powder,
- Require good and constant agitation (usually mechanical) in the spray tank and quickly settle out if agitation is turned off,
- Abrasive to many pumps and nozzles, causing them to wear out quickly,
- Difficult to mix in very hard or very alkaline water,
- Often clog nozzles and screens,
- Residues may be visible.

### **Soluble powders (SP or WSP)**

Soluble powder formulations look like wettable powders. However, when mixed with water, soluble powders dissolve readily and form a true solution. After they are mixed thoroughly, no additional agitation is necessary. The amount of active ingredient in soluble powders ranges from 15 to 95 percent; it usually is over 50 percent. Soluble powders have all the advantages of wettable powders and none of the disadvantages except the inhalation hazard during mixing. Few pesticides are available in this formulation, because few active ingredients are soluble in water.

### **Microencapsulated Pesticides (M)**

Microencapsulated formulations are particles of pesticides (liquid or dry) surrounded by a plastic coating. The formulated product is mixed with water and applied as a spray. Once applied, the capsule slowly releases the pesticide. The encapsulation process can prolong the active life of the pesticide by providing a timed release of the active ingredient.

#### **Advantages:**

- Increased safety to applicator,
- Easy to mix, handle, and apply,
- Releases pesticide over a period of time.

#### **Disadvantages:**

- Constant agitation necessary in tank,
- Some bees may pick up the capsules and carry them back to their hive where the released pesticide may poison the entire hive.

### **Water-Dispersible Granules (Dry Flowables) (WDG or DF)**

Water-dispersible granular formulations are like wettable powder formulations, except the active ingredient is prepared as granule-sized particles. Water-dispersible granules must be mixed with water to be applied. Once in water, the granules break apart into fine powder. The formulation requires constant agitation to keep it suspended in water. Water-dispersible granules share the advantages and disadvantages of wettable powders except:

- They are more easily measured and mixed,
- They cause less inhalation hazard to the applicator during pouring and mixing.

## Fumigants

Fumigants are pesticides that form poisonous gases when applied. Some active ingredients are liquids when packaged under high pressure but change to gases when they are released. Other active ingredients are volatile liquids when enclosed in an ordinary container and so are not formulated under pressure. Others are solids that release gases when applied under conditions of high humidity or in the presence of water vapor. Fumigants are used for structural pest control, in food and grain storage facilities, and in regulatory pest control at ports of entry and at State and national borders. In agricultural pest control, fumigants are used in soil and in greenhouses, granaries, and grain bins.

### Advantages:

- Toxic to a wide range of pests,
- Can penetrate cracks, crevices, wood, and tightly packed areas such as soil or grains,
- Single treatment usually will kill most pests in treated area.

### Disadvantages:

- The target site must be enclosed or covered to prevent the gas from escaping,
- Highly toxic to humans and all other living organisms,
- Require the use of specialized protective equipment, including respirators,

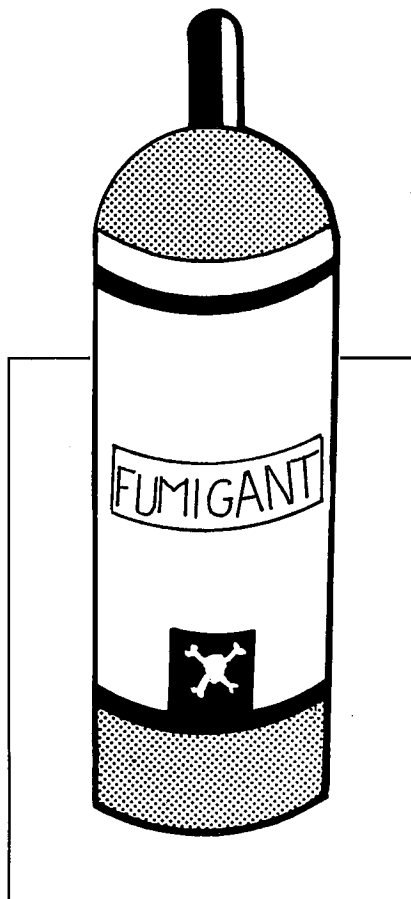

- Require the use of specialized application equipment.

## Adjuvants

An adjuvant is a chemical added to a pesticide formulation or tank mix to increase its effectiveness or safety. Most pesticide formulations contain at least a small percentage of adjuvants. Some of the most common adjuvants are **surfactants** — “surface active ingredients” that

alter the dispersing, spreading, and wetting properties of spray droplets.

Common adjuvants are:

- **Wetting agents** — allow wettable powders to mix with water.
- **Emulsifiers** — allow petroleum-based pesticides (EC's) to mix with water.
- **Invert emulsifiers** — allow water-based pesticides to mix with petroleum carrier.
- **Spreaders** — allow pesticide to form a uniform coating layer over the treated surface.
- **Stickers** — allow pesticide to stay on the treated surface.
- **Penetrants** — allow the pesticide to get through the outer surface to the inside of the treated area.
- **Foaming agents** — reduce drift.
- **Thickeners** — reduce drift by increasing droplet size.
- **Safeners** — reduce the toxicity of a pesticide formulation to the pesticide handler or to the treated surface.
- **Compatibility agents** — aid in combining pesticides effectively.
- **Buffers** — allow pesticides to be mixed with diluents or other pesticides of different acidity or alkalinity.
- **Anti-foaming agents** — reduce foaming of spray mixtures that require vigorous agitation.

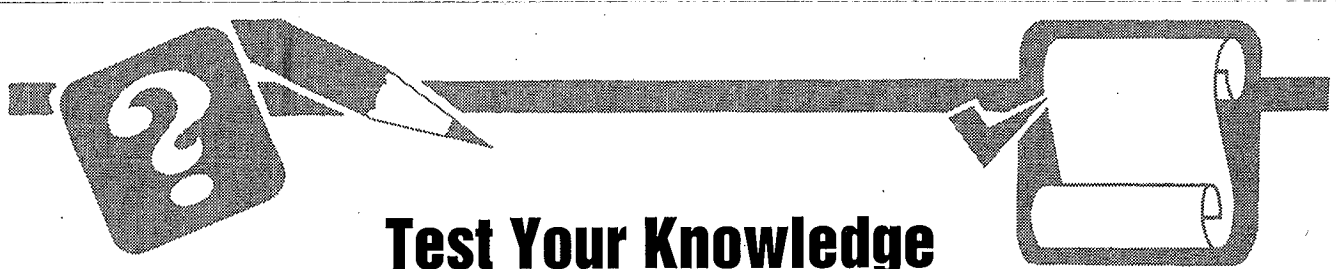

## Test Your Knowledge

**Q.** What is a pesticide formulation?

**A.** A pesticide formulation is the mixture of active and inert (inactive) ingredients that forms a pesticide product.

**Q.** What is the difference between active ingredients and inert ingredients?

**A.** Active ingredients are the chemicals in a pesticide product that control pests. Inert ingredients are the chemicals in a pesticide product that are added to make the product safer, more effective, easier to measure, mix, and apply, and more convenient to handle.

**Q.** What types of factors should you consider when you have a choice of formulations for a pest control task?

**A.** You should think about the characteristics of each formulation, and you should consider which of the formulation's advantages and disadvantages are important in your application situation. Also consider the following: Do you have the right

application equipment? Can you apply the formulation safely? Will the formulation reach the target and stay in place long enough to control the pest? Might the formulation harm the target site?

**Q.** If you had a choice of either a wettable powder formulation or a granular formulation for a particular pest control task, which would be best if drift were a major concern? Which would be best if you need the pesticide to stay on a surface that is not level, such as foliage?

**A.** The granular formulation would be the best choice in the first situation, because granules have a much lower drift hazard than wettable powders. Granules do not stick to nonlevel surfaces, so the wettable powder would be the best choice in the second situation.

**Q.** If you had a choice of either a wettable powder or an emulsifiable concentrate for a particular pest control task, which would be better if you were concerned about harming the treated surface? Which would be best if you were diluting with very hard or alkaline water?

**A.** The wettable powder would be the best choice in the first situation, because EC's are corrosive and may cause pitting, discoloration, or other damage to treated surfaces. Wettable powders are difficult to mix in very hard or very alkaline water, so the EC formulation would be the best choice in the second situation.

**Q.** Why are adjuvants sometimes added to pesticide formulations?

**A.** Adjuvants are added to a pesticide formulation or tank mix to increase its effectiveness or safety.

**Q.** What type(s) of adjuvants should you consider for reducing drift? for coating a surface evenly? when you wish to combine two or more pesticides for one application?

**A.** Foaming agents and thickeners help to reduce drift. Spreaders help to coat the treated surface with an even layer of pesticide. Compatibility agents aid in combining pesticides effectively.



---

# Pesticides in the Environment



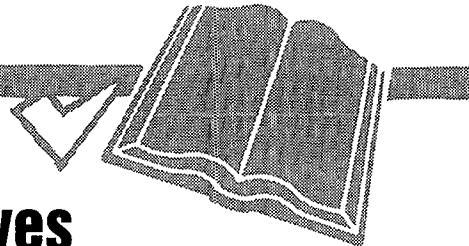
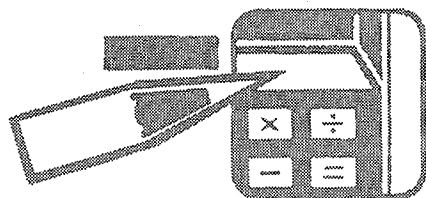

## Learning Objectives

After you complete your study of this unit, you should be able to:

- Explain the meaning of the word “environment.”
- Distinguish between point-sources and non-point-sources of environmental contamination by pesticides.
- List factors you should consider when you accidentally or intentionally release a pesticide into the environment.

■ Explain why sensitive areas are important considerations for pesticide handlers.

■ Name the routes by which pesticides can move offsite into the environment.

■ Describe factors that influence whether pesticides will move offsite in the air.

■ Describe factors that influence whether pesticides will move offsite in water.

■ Describe ways that pesticides move offsite in or on objects, plants, or animals.

■ Recognize that nontarget plants and animals can be harmed by both pesticides and pesticide residues.

■ Describe harmful effects that pesticides can have on surfaces.

## Terms To Know

**Back-siphoning** — The movement of liquid pesticide mixture back through the filling hose and into the water source.

**Collection pad or tray** — A safety system designed to contain and recover spills, rinsates, leaks, and other pesticide-containing substances.

**Concentrates** — Pesticides that have a high percentage of active ingredient.

**Endangered species** — Organisms whose survival as a species has been designated by a Federal agency to be endangered or threatened.

**Ground water** — Water beneath the earth's surface in soil or rock.

**Labeling** — The pesticide product label and other accompanying materials that contain directions that pesticide users are legally required to follow.

**Nontarget** — Any site or organism other than the site or pest at which the pesticide is being directed.

**Offsite** — Outside the area where the pesticide is being released.

**Personal protective equipment (PPE)** — Devices and clothing worn to protect the human body from contact with pesticides or pesticide residues.

**Pesticide handler** — Person who directly works with pesticides, such as during mixing, loading, transporting, storing, disposing, and applying, or working on pesticide equipment.

**Precautionary statements** — Statements on pesticide labeling that alert you to possible hazards from use of the pesticide product and that sometimes indicate specific actions to take to avoid the hazards.

**Release** — When a pesticide leaves its container or the equipment or system that is containing it and enters the environment. Release can be intentional, as in an application, or by accident, as in a spill or leak.

**Rinsate** — Pesticide-containing water (or another liquid) that results from rinsing a pesticide container, pesticide equipment, or other pesticide-containing materials.

**Runoff** — The movement of pesticide away from the release site in water or another liquid flowing horizontally across the surface.

**Surface water** — Water on top of the earth's surface, such as in lakes, streams, rivers, irrigation ditches, or storm water drains.

**Target** — The site or pest toward which control measures are being directed.

**Use site** — The immediate environment where a pesticide is being mixed, loaded, applied, transported, stored, or disposed of, or where pesticide-contaminated equipment is being cleaned.

**Volatile** — Evaporating rapidly; turning easily into a gas or vapor.

**T**he environment is everything that is around us. It includes not only the natural elements that the word "environment" most often brings to mind, but also people and the manmade components of our world. Neither is the environment limited to the outdoors — it also includes the indoor areas in which we live and work.

The environment, then, is much more than the oceans and the ozone layer. It is air, soil, water, plants, animals, houses, restaurants, office buildings, and factories and all that they contain. Anyone who uses a pesticide — indoors or outdoors, in a city or in the country — must consider how that pesticide will affect the environment.

The user must ask two questions:

- How will this pesticide affect the immediate environment at the site where it is being used?
- What are the dangers that the pesticide will move out of the use site and cause harm to other parts of the environment?

Pesticides can harm all types of environments if they are not used correctly.



**Responsible pesticide users know and follow good practices that achieve effective pest control with very little risk of environmental damage.**

Pesticide product labeling statements are intended to alert you to particular environmental

concerns that a pesticide product poses. Use good judgment, too. The lack of a particular precautionary statement does not necessarily mean that the product poses no hazard to the environment.

Both the public and the Environmental Protection Agency (EPA) are becoming increasingly concerned about harmful effects on the environment from the use of pesticides. As a result, EPA is looking closely at environmental effects as it considers new applications for registration, and it also is taking another look at existing pesticide registrations. Hazards to humans had been the primary reason for EPA to classify a pesticide as a restricted-use product. Now, more and more pesticide labels list environmental effects, such as contamination of ground water or toxicity to birds or aquatic invertebrate animals, as a reason for restriction.

## **Sources of Contamination**

When environmental contamination occurs, it is the result of either point-source or non-point-source pollution. Point-source pollution comes from a specific, identifiable place (point). A

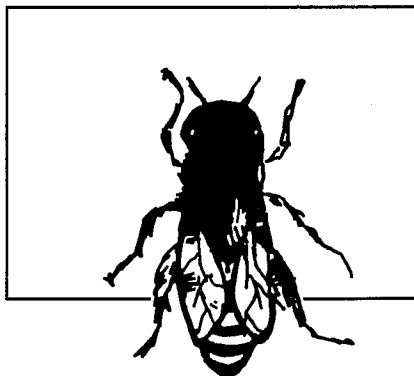

pesticide spill that moves into a storm sewer is an example of point-source pollution. Non-point-source pollution comes from a wide area. The movement of pesticides into streams after broadcast applications is an example of non-point-source pollution.

Non-point-source pollution from pesticide applications is the source that has most commonly been blamed for pesticide contamination in the outdoor environment. But more and more studies are revealing that, in fact, much environmental contamination does not result from non-point-source pollution. Contamination also results from point sources, such as:

- wash water and spills produced at equipment cleanup sites,
- improper disposal of containers, water from rinsing containers, and excess pesticides,
- pesticide storage sites where leaks and spills are not correctly cleaned up, and
- spills that occur while mixing concentrates or loading pesticides into application equipment.

**These kinds of tasks are involved with nearly every pesticide use, whether the pesticide is applied outdoors or in or around an enclosed structure.**

As a pesticide handler, especially if you use and supervise the use of restricted-use pesticides, you must become aware of the potential for environmental contamination during every phase of your pesticide operation. Many pesticide uses are restricted because of environmental concerns. Whenever you release a pesticide into the environment — whether intentionally or accidentally — consider:

- whether there are sensitive areas in the environment at the pesticide use site that might be harmed by contact with the pesticide,
- whether there are sensitive offsite areas near the use site that might be harmed by contact with the pesticide,
- whether there are conditions in the environment at the pesticide use site that might cause the pesticide to move offsite, and
- whether you need to change any factors in your application or in the pesticide use site to reduce the risk of environmental contamination.

## Sensitive Areas

Sensitive areas are sites or living things that are easily injured by a pesticide.

Sensitive areas outdoors include:

- areas where ground water is near the surface or easily accessed

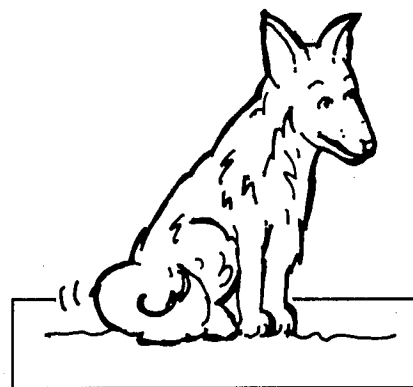

(wells, sinkholes, porous soil, etc.),

- areas in or near surface water,
- areas near schools, playgrounds, hospitals, and other institutions,
- areas near the habitats of endangered species,
- areas near apiaries (honeybee sites), wildlife refuges, or parks, and
- areas near ornamental gardens, food or feed crops, or other sensitive plantings.

Sensitive areas indoors include:

- areas where people — especially children, pregnant women, the elderly, or the sick — live, work, or are cared for,
- areas where food or feed is processed, prepared, stored, or served,
- areas where domestic or confined animals live, eat, or are otherwise cared for, and
- areas where ornamental or other sensitive plantings are grown or maintained.

Sometimes pesticides must be deliberately applied to a sensitive area to control a pest. These applications should be performed by persons who are well trained about how to avoid causing injury in such areas.

At other times, the sensitive area is part of a larger target site. Whenever possible, take special precautions to avoid direct application to the sensitive area. For example, leaving an untreated buffer zone around sensitive areas



is often a practical way to avoid contaminating them.

In still other instances, the sensitive area may be near a site that is used for application, mixing/loading, storage, disposal, or equipment washing. The pesticide users must take precautions to avoid accidental contamination of the sensitive area. For example, a permanent site for mixing/loading or equipment washing could be equipped with a collection pad or tray to catch and contain leaks, spills, or waste water.

Typical pesticide labeling statements that alert you to these concerns include:

*Do not use in hospital patient quarters.*

*Remove all animals from building prior to treatment and keep animals out until spray has dried.*

*Applications prohibited in areas where food is held, processed, prepared or served.*

*Do not use around home gardens, schools, recreational parks, or playgrounds.*

*In living areas, make applications in such a manner as to avoid deposits on exposed surfaces or*

*introducing the material into the air.*

*Do not use in or around residences.*

## Pesticide Movement

Pesticides that move away from the release site may cause environmental contamination. Pesticides move away from the release site both indoors and outdoors and may cause harm in both environments. Pesticides move in several ways, including:

- in air, through wind or through air currents generated by ventilation systems,
- in water, through runoff or leaching,
- on or in objects, plants, or animals (including humans) that move or are moved offsite.

### Air

Pesticide movement away from the release site in the air is usually called **drift**. Pesticide particles, dusts, spray droplets, and vapors all may be carried offsite in the air. People who mix, load, and apply pesticides outdoors usually are aware of the ease with which pesticides drift offsite. People who handle pesticides indoors may not realize how easily some pesticides move offsite in the air currents

created by ventilation systems and by forced-air heating and cooling systems.

### Particles and droplets

Lightweight particles, such as dusts and wettable powders, are easily carried by moving air. Granules and pellets are much heavier and tend to settle out of air quickly. Small spray droplets also are easily carried in air currents. High-pressure and fine nozzles produce very small spray droplets that are very likely to drift. Lower pressure and coarse nozzles produce larger droplets with less drift potential.

The likelihood that pesticide particles and spray droplets will drift offsite depends partly on the way they are released. Pesticides released close to the ground or floor are not as likely to be caught up in air currents as those released from a greater height. Pesticides applied in an upward direction or from an aircraft are the most likely to be carried on air currents.

### Vapors

Pesticide vapors move about easily in air. Fumigant pesticides are intended to form a vapor when they are released. Persons using fumigants must take precautions to make sure the fumigant remains in a sealed container until it is released into the application site, which also must be sealed to prevent the vapor from escaping. Some nonfumigant pesticides also can vaporize and escape into the air. The labeling of volatile pesticides often includes warning statements that the pesticide handler should heed. Any time you release a volatile pesticide in an enclosed area, consider the hazards not only to yourself and to fellow workers, but also to people, animals, and plants that are in or near the release site or that may

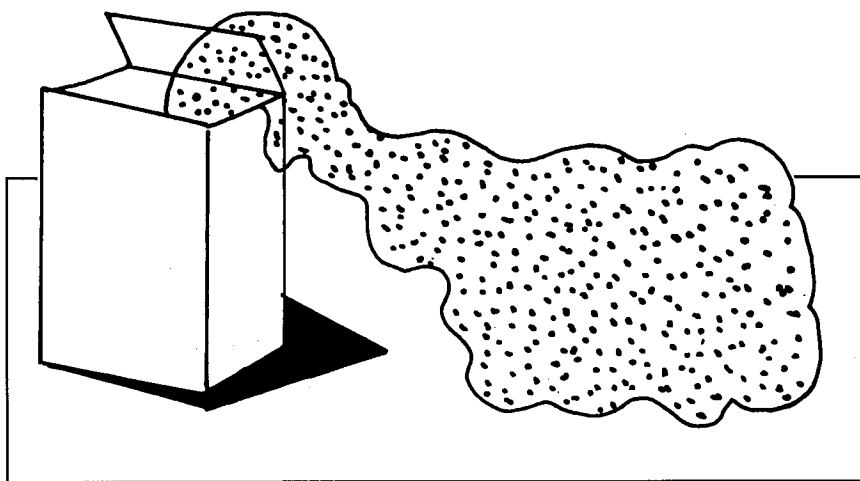

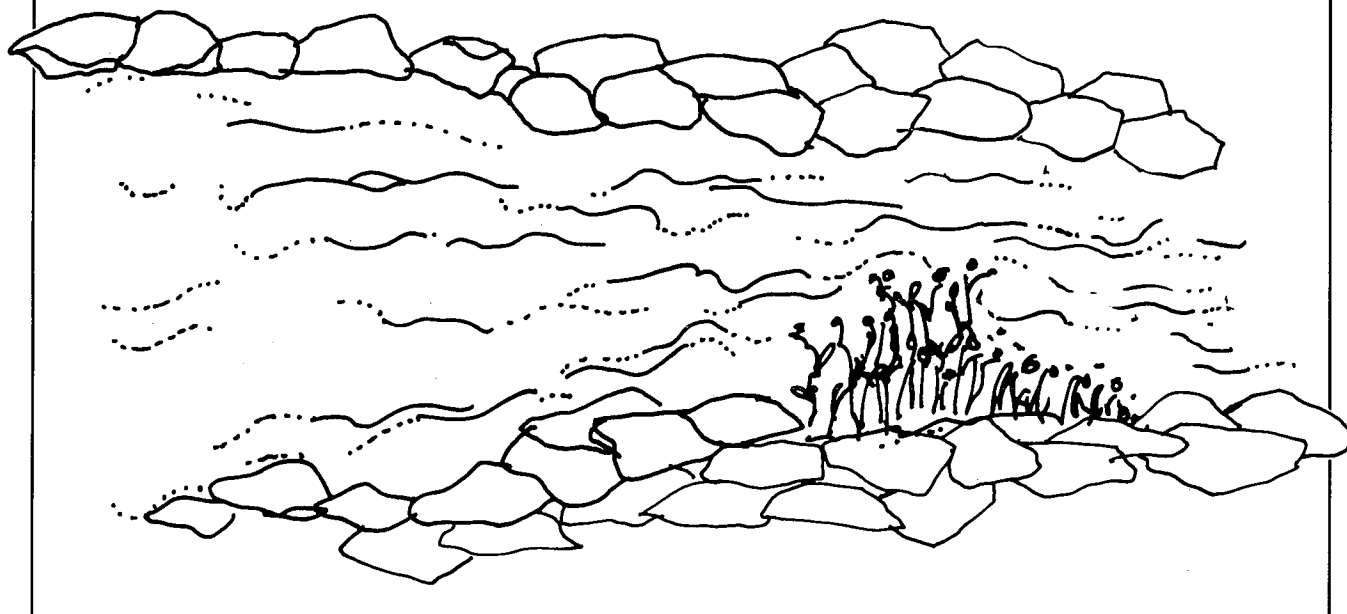

enter the area soon after the release.

Typical pesticide labeling statements that alert you to avoid drift include:

*Do not apply when weather conditions favor drift from areas treated.*

*Do not allow drift onto plants intended for food or feed.*

*Drift from treated areas may be hazardous to aquatic organisms in neighboring areas.*

## Water

Pesticide particles and liquids may be carried offsite in water.

Pesticides can enter water through:

- drift, leaching, and runoff from nearby applications,
- spills, leaks, and back-siphoning from nearby mixing, loading, storage, and equipment cleanup sites, and
- improper disposal of pesticides, rinsates, and containers.

Most pesticide movement in water is across the treated surface (runoff) or downward from the surface (leaching). Runoff and leaching may occur when:

- too much liquid pesticide is applied, leaked, or spilled onto a surface, or
- too much rainwater, irrigation water, or other water gets onto a surface containing pesticide residue.

Runoff water in the outdoor environment may travel into drainage ditches, streams, ponds, or other surface water where the pesticides can be carried great distances offsite. Pesticides that leach downward through the soil in the outdoor environment sometimes reach the ground water.

Runoff water in the indoor environment may get into domestic water systems and from there into surface water and ground water. Runoff can flow into floor drains or other drains and into the water system. Sometimes a careless pesticide handler washes

pesticide down a sink drain and into the water system.

Some pesticides can leach downwards in indoor environments. In a greenhouse, for example, pesticides may leach through the soil or other planting medium to floors or benches below. Some pesticides used indoors may be absorbed into carpets, wood, and other porous surfaces and remain trapped for a long time.

Typical pesticide labeling statements that alert you to these concerns include:

*Do not contaminate water through runoff, spills, or improper disposal of excess pesticide, spray mixtures, or rinsates.*

*Do not allow runoff or spray to contaminate wells, irrigation ditches, or any body of water used for irrigation or domestic purposes.*

*Do not apply directly to water and wetlands (swamps, bogs, marshes, and potholes).*

*Maintain a buffer zone (lay-off distance) of 100 feet from bodies of water.*

*This product is water soluble and can move with surface runoff water. Do not contaminate cropland, water, or irrigation ditches.*

## **On or in Objects, Plants, or Animals**

Pesticides can move away from the release site when they are on or in objects or organisms that move (or are moved) offsite. Pesticides may stick to shoes or clothing, to animal fur, or to blowing dust and be transferred to other surfaces. When pesticide handlers bring home or wear home contaminated personal protective equipment, work clothing, or other items, residues can rub off on carpeting, furniture, and laundry items and onto pets and people.

Pesticides may stick to treated surfaces, such as food or feed products that are to be sold. To protect consumers, there are legal limits (tolerances) for how much pesticide residue may safely remain on crops or animal products that are sold for food or feed. Products that exceed these tolerances are illegal and cannot be sold. Crops and animal products will not be over tolerance if the pesticides are applied as directed on the product labeling. Illegal pesticide residues usually result when:

- too much pesticide is applied to the crop or animal,

- the days-to-harvest, days-to-grazing, or days-to-slaughter directions on the pesticide labeling are not obeyed, or
- pesticides move out of the release site and contaminate plants or animals nearby.

Typical pesticide labeling statements that alert you to these concerns include:

*Do not apply within 5 days of harvest.*

*Do not apply under conditions involving possible drift to food, forage, or other plantings that might be damaged or the crops thereof rendered unfit for sale, use, or consumption.*

*Remove meat animals from treated areas at least 1 day before slaughter if they were present at application or grazed treated areas within 21 days after application.*

*Do not pasture or feed treated hay to lactating dairy cattle within 21 days after application.*

## **Harmful Effects on Nontarget Plants and Animals**

Nontarget organisms may be harmed by pesticides in two ways:

- The pesticide may cause injury by contacting the nontarget organism directly, or
- The pesticide may leave a residue that causes later injuries.

### **Harmful Effects from Direct Contact**

Pesticides may harm nontarget organisms that are present during

a pesticide application. Poorly timed applications can kill bees and other pollinators that are active in or near the target site. Pesticides may harm other wildlife, too. Even tiny amounts of some pesticides may harm them or destroy their source of food.

Pesticides applied over large areas, such as in mosquito, biting fly, and forest pest control, must be chosen with great care to avoid poisoning nontarget plants and animals in or near the target site. Read the warnings and directions on the pesticide labeling carefully to avoid harming nontarget organisms during a pesticide application.

Drift from the target site may injure wildlife, livestock, pets, sensitive plants, and people. For example, drift of herbicides can damage sensitive nearby plants, including crops, forests, or ornamental plantings. Drift also can kill beneficial parasites and predators that are near the target site.

Pesticide runoff may harm fish and other aquatic animals and plants in ponds, streams, and lakes. Aquatic life also can be harmed by careless tank filling or draining and by rinsing or discarding used containers along or in waterways.

Typical pesticide labeling statements that alert you to these concerns include:

*Phytotoxic. Do not spray on plants.*

*Do not apply this product or allow it to drift to blooming crops or weeds if bees are visiting the treatment area.*

*Extremely toxic to aquatic organisms. Do not contaminate water by cleaning of equipment or disposal of wastes.*

*This product is toxic to fish, shrimp, crab, birds, and other wildlife. Keep out of lakes, streams, ponds, tidal marshes, and estuaries. Shrimp and crab may be killed at application rates. Do not apply where these are important resources.*

### **Harmful Effects From Residues**

A residue is the part of a pesticide that remains in the environment for a period of time following application or a spill. Pesticides usually break down into harmless components after they are released into an environment. The breakdown time ranges from less than a day to several years. The rate of pesticide breakdown depends mostly on the chemical structure of the pesticide active ingredient. The rate of pesticide breakdown also may be affected by environmental conditions at the release site, such as:

- surface type, chemical composition, and pH,
- surface moisture,
- presence of microorganisms,
- temperature, and
- exposure to direct sunlight.

**Persistent** pesticides leave residues that stay in the environment without breaking down for long periods of time. These pesticides are sometimes desirable, because they provide long-term pest control and may reduce the need for repeated applications. However, some persistent pesticides that are applied to or spilled on soil, plants, lumber, and other surfaces or into water can later cause harm to sensitive

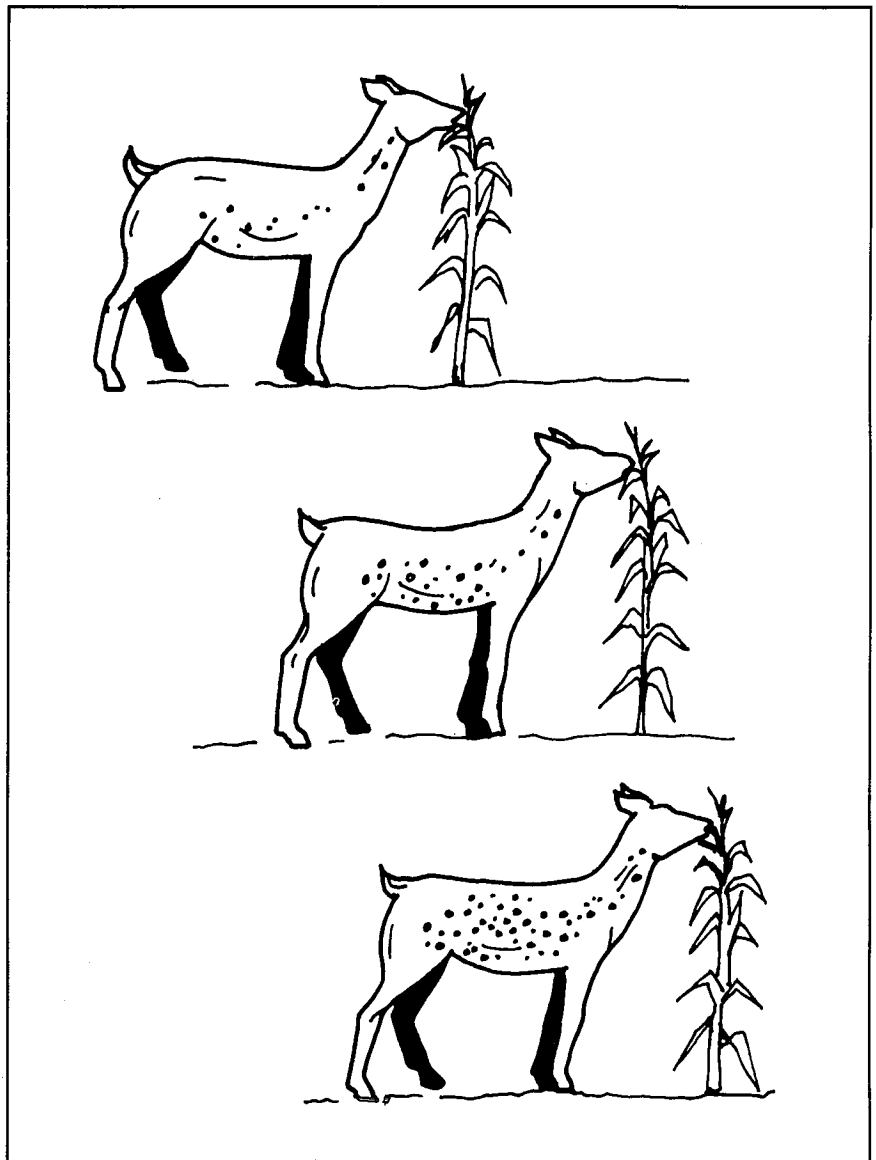

plants or animals, including humans, that contact them. Clues on pesticide labeling that a particular pesticide product is likely to be persistent include:

*Can remain in the soil for 34 months or more and cause injury to certain crops other than those listed as acceptable on the label.*

*This product can remain phytotoxic for a year or more.*

When using persistent pesticides, consider whether their continued presence in the environment is likely to harm plants and animals.

When pesticides build up in the bodies of animals or in the soil, they are said to **accumulate**. When the same mixing/loading site or equipment cleaning site is used frequently without taking steps to limit and clean up spills, pesticides are likely to accumulate in the soil. When this occurs, plants, animals, and objects that come into contact with the soil may be harmed. When pesticides accumulate in the soil, there is also a higher likelihood that the pesticides will move offsite and contaminate the surrounding environment or move into surface or ground water.

Sometimes animals can be harmed when they feed on plants or animals that have pesticide residues on or in them. A special concern is for predator birds or mammals that feed on animals that have been killed by pesticides. The predators may be harmed by the pesticide residues remaining on or in the bodies of the dead animals.

Typical pesticide labeling statements that alert you to these concerns include:

*Toxic to fish, birds, and wildlife. This product can pose a secondary hazard to birds of prey and mammals.*

*Do not use fish as food or feed within 3 days of application.*

*Animals feeding on treated areas may be killed and pose a hazard to hawks and other birds-of-prey. Bury or otherwise dispose of dead animals to prevent poisoning of other wildlife.*

## Harmful Effects on Surfaces

Sometimes surfaces are harmed by pesticides or pesticide residues. Some surfaces may become discolored by contact with certain pesticides. Other surfaces may be pitted or marked by contact with some pesticides. Some pesticides can corrode or obstruct electronic systems or metal. Sometimes a pesticide will leave a visible deposit on the treated surface.

Typical pesticide labeling statements that alert you to these concerns include:

*Do not apply to carpeting, linoleum, or other porous floor coverings, as discoloration may result.*

*Do not spray on plastic, painted, or varnished surfaces.*

*May cause pitting of automobile and other vehicle paint.*

*Do not spray directly into any electronic equipment or into outlets and switches, or any other location where the pesticide may foul or short-circuit contacts and circuits.*

*A visible deposit may occur on some dark surfaces.*

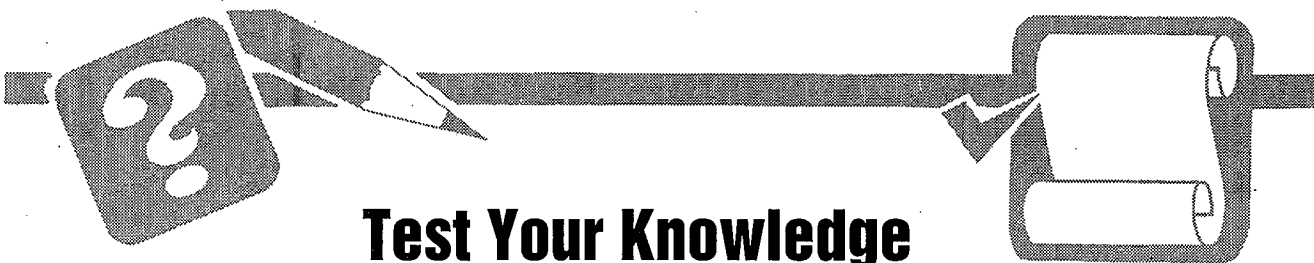

## Test Your Knowledge

**Q.** What is the “environment”?

**A.** Environment is everything that surrounds us — indoors and outdoors — including natural elements, manmade objects, people, and other living organisms.

**Q.** Explain what is meant by point-source and non-point-source contamination of the environment by pesticides, and give an example of each.

**A.** Point-source pollution comes from a specific, identifiable place (point). A pesticide spill that moves into a storm sewer is an example of point-source pollution.

Non-point-source pollution comes from a wide area. The movement of pesticides into streams after broadcast applications is an example of non-point-source pollution.

**Q.** Name some ways that careless pesticide handling could lead to point-source pollution.

**A.** Ways that careless pesticide handling could cause point-source pollution include, for example:

1. Mismanagement of wash water and spills produced at equipment cleanup sites.
2. Improper disposal of containers, water from rinsing containers, and excess pesticides.

3. Failure to correctly clean up leaks and spills at pesticide storage sites.

4. Spilling pesticides while mixing concentrates or loading pesticides into application equipment.

**Q.** What environmental factors should you consider any time you accidentally or intentionally release a pesticide into an environment?

**A.** Consider:

1. Whether there are sensitive areas in the environment at the pesticide use site that might be harmed by contact with the pesticide,

2. Whether there are sensitive offsite areas near the use site that might be harmed by contact with the pesticide,
3. Whether there are conditions in the immediate environment that might cause the pesticide to move offsite, and
4. Whether you can change any factors in your application or in the pesticide use site to reduce the risk of environmental contamination.

**Q.** What is a “sensitive area”? Give four examples of sensitive areas that you must be especially careful to protect when you are handling pesticides.

**A.** Sensitive areas are sites or living things in environments that are easily injured by a pesticide. Some examples of sensitive areas are: places where pesticides might get into ground water or surface water; homes, schools, playgrounds, hospitals, and other places where people are present; places where there are animals — endangered species, bees, other wildlife, livestock, pets; places where crops, ornamental plants, or other sensitive plants are growing; and areas where food or feed is processed, stored, or served.

**Q.** List three routes by which pesticides can move offsite.

- A.**
1. In air, through wind or through air currents generated by ventilation systems.
  2. In water, through runoff or leaching.
  3. On or in objects, plants, or animals (including humans) that move or are moved offsite.

**Q.** What factors influence whether a pesticide will move offsite in the air?

- A.**
1. Droplet or particle size.
  2. Height and direction of release.
  3. Whether the pesticide tends to form vapors.

**Q.** Name two circumstances that might cause a pesticide to move offsite in water.

- A.**
1. Too much liquid pesticide is applied, leaked, or spilled onto a surface.
  2. Too much rainwater, irrigation water, or wash water gets onto a surface that contains pesticide residue.

**Q.** Give some examples of ways that pesticides can move offsite on or in objects, plants, or animals.

**A.** 1. Pesticides may be carried offsite if they stick to such things as shoes or clothing, animal fur, or blowing dust — anything that moves from the use site to another location.

2. Pesticide residues may remain on treated surfaces, such as food or feed products, when they are taken from the use site to be sold.

**Q.** In addition to direct contact with the pesticide during application or through drift or runoff, how else may nontarget plants and animals be harmed by a pesticide?

**A.** Nontarget plants and animals may be harmed by the pesticide residues that stay in the environment for a period of time after the release. These can be residues that remain in soil or on surfaces, or they may be residues that build up in the bodies of animals, harming those animals themselves and sometimes other animals that feed on them.

**Q.** What kinds of damage can some pesticides cause to surfaces?

**A.** Surfaces may become discolored, be pitted or marked, be corroded or obstructed, or be left with a visible deposit.

---

# Special Environmental Concerns

## Protecting Ground Water and Endangered Species

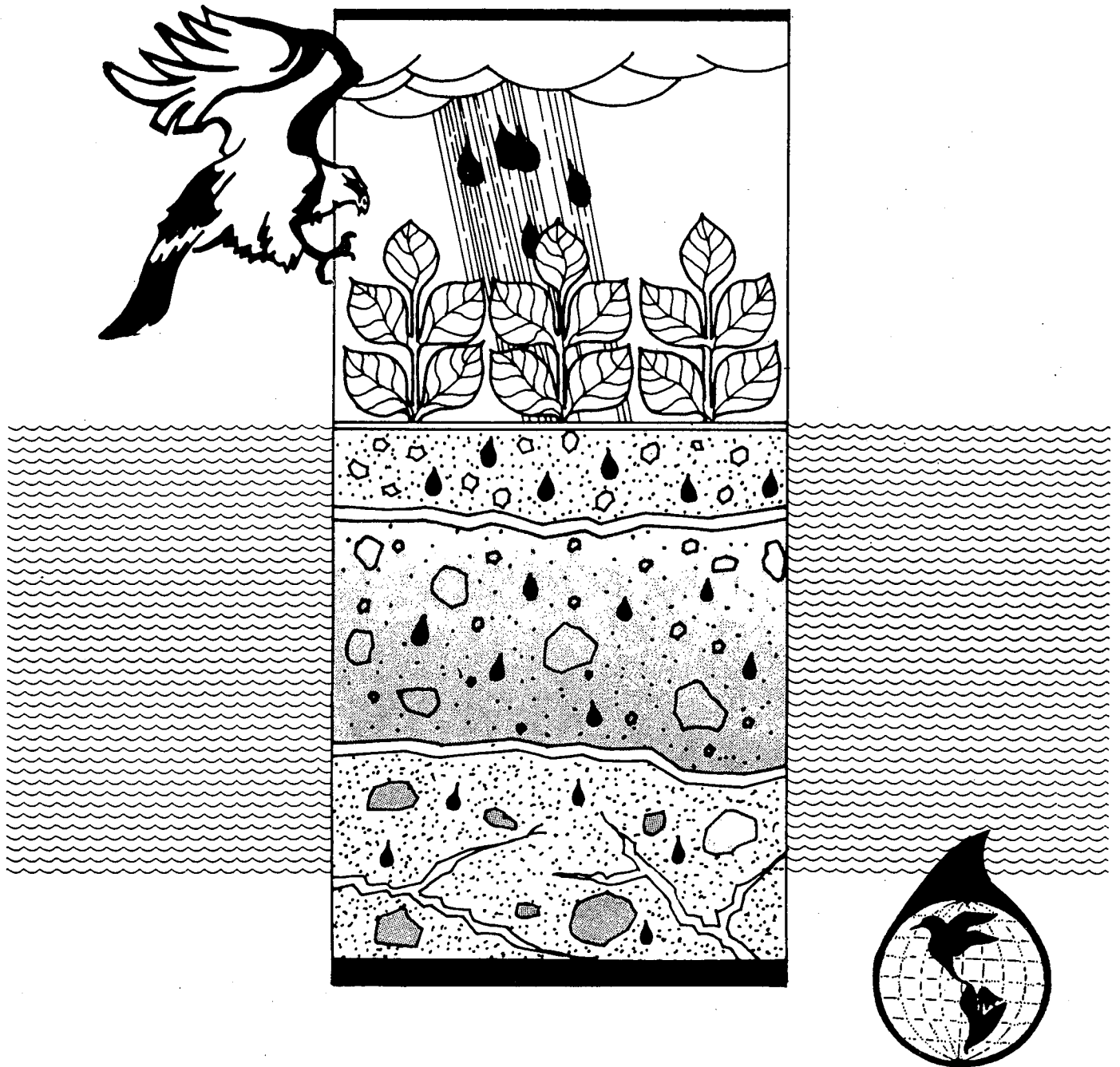

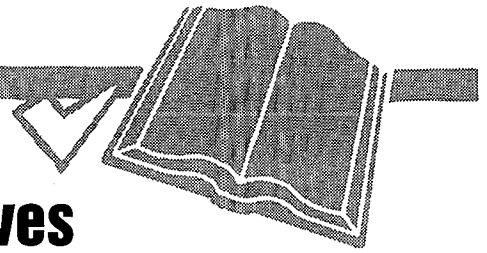
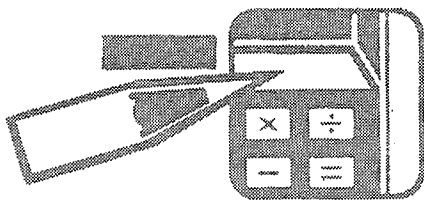

# Learning Objectives

After you complete your study of this unit, you should be able to:

- Name pesticide handling activities that pose a threat to ground water or endangered species.
- Explain why the location of your pesticide use site is the main factor that determines whether you must take special steps to protect ground water and endangered species.
- Explain where to find out whether your pesticide use is

subject to any special limitations related to ground water or endangered species.

- Name factors that determine whether pesticides will reach ground water.
- Describe actions that pesticide users can take to avoid pesticide contamination of ground water.
- Explain how water on surfaces at the release site affects the movement of pesticides into ground water.
- Explain how the solubility, adsorption, and persistence of a

pesticide influence its movement into ground water.

- Explain how soil type affects the movement of pesticides into ground water.
- Describe how the geology of a release site affects the movement of pesticides into ground water.
- Define “endangered species.”
- Explain the concept of habitat.
- Define biological diversity.
- Describe how pesticides may harm endangered species.

## Terms To Know

**Back-siphoning** — The movement of liquid pesticide mixture back through the filling hose and into the water source.

**Drift** — Pesticide movement away from the release site in the air.

**Ecosystem** — A system formed by the interaction of a community of organisms with their environment.

**Endangered species** — Organisms whose survival as a species has been designated by a Federal agency to be endangered or threatened.

**Exposed** — Subjected to contact with pesticides.

**Ground water** — Water beneath the earth’s surface in soil or rock.

**Labeling** — The pesticide product label and other accompanying materials that contain directions that pesticide users are legally required to follow.

**Leaching** — The movement of pesticide in water or another liquid downward through soil or other planting medium.

**Organic matter** — Materials and debris that originated as living plants or animals.

**Pesticide handler** — Person who directly works with pesticides, such as during mixing, loading, transporting, storing, disposing, and applying, or working on pesticide equipment.

**Predator** — An organism that attacks, kills, and feeds on other organisms.

**Release** — When a pesticide leaves its container or the equipment or system that

is containing it and enters the environment. Release can be intentional, as in an application, or by accident, as in a spill or leak.

**Runoff** — The movement of pesticide away from the release site in water or another liquid flowing horizontally across the surface.

**Surface water** — Water on top of the earth’s surface, such as in lakes, streams, rivers, irrigation ditches, or storm water drains.

**Use site** — The immediate environment where a pesticide is being mixed, loaded, applied, transported, stored, or disposed of, or where pesticide-contaminated equipment is being cleaned.



---

**C**oncerns about wildlife and the environment are becoming more important in decisions about which pesticides will be registered and what they may be used for. Two environmental concerns are receiving particular attention:

- protection of ground water, and
- protection of endangered species.

Federal and State efforts to protect ground water and endangered species are resulting in new instructions and limitations for pesticide handlers. Whether you apply pesticides indoors or outdoors, in an urban area or in a rural area, you must become aware of the importance of protecting these two vital national resources. Pesticides that are incorrectly or

accidentally released into the environment — either during application or during other handling activities, such as mixing, loading, equipment cleaning, storage, transportation, or disposal — pose a threat to ground water and endangered species.

Whether you must take special action to protect ground water and endangered species depends mainly on the location of your use site. Ground water contamination is of greatest concern in release sites where ground water is close to the surface or where the soil type or the geology allows contaminants to reach ground water easily. Protection of endangered species usually is required only in locations where they currently live or are being reintroduced. Read the pesticide labeling carefully to

determine whether your pesticide use is subject to any special ground water or endangered species limitations.

The U.S. Environmental Protection Agency may establish specific limitations or instructions for pesticide users in locations where ground water or endangered species are most at risk. These limitations and instructions are often too long to be included in pesticide labeling. The labeling may tell you that you must consult another source for the details about the instructions and limitations that apply in your situation. Your legal responsibility for following instructions that are distributed separately is the same as it is for instructions that appear in full on the pesticide labeling.

---

## Protecting Ground Water

Ground water is water located beneath the earth's surface. Many people think that ground water occurs in vast underground lakes, rivers, or streams. Usually, however, it is located in rock and soil. It moves very slowly through irregular spaces within otherwise solid rock or seeps between particles of sand, clay, and gravel. An exception is in limestone areas, where ground water may flow through large underground chan-

nels or caverns. Surface water may move several feet in a second or a minute. Ground water may move only a few feet in a month or a year. If the ground water is capable of providing significant quantities of water to a well or spring, it is called an **aquifer**. Pesticide contamination of aquifers is very troubling, because these are sources of drinking, washing, and irrigation water.

### Sources of Ground Water

Ground water is recharged (replaced) mostly from rain or snow that enters the soil. However, some water from lakes and streams and from irrigation also becomes ground water. Water that is above the ground can move in three ways — it can evaporate into the air; it can move across the surface, as in a stream or river; or

it can move downward from the surface. Some of the water that moves downward is absorbed by plants and other organisms. Another portion of the downward-moving water is held in the upper layers of the soil. The rest moves down through the root zone and the relatively dry soil zone until it reaches a zone saturated with water. This saturated zone is the uppermost layer of ground water and is called the water table. The water table is the “dividing line” between the ground water and the unsaturated rock or soil above it.

## Pesticide Contamination of Ground Water

When water that is moving downward from the surface contains pesticides — or comes into contact with them as it moves — the pesticides may be carried along with the water until they eventually reach the ground water. Five major factors determine whether a pesticide will reach ground water:

- the practices followed by pesticide users,
- the presence or absence of water on the surface of the site where the pesticides are released,
- the chemical characteristics of the pesticides,
- the type of soil in the site where the pesticides are released,
- the location of the ground water — its distance from the surface and the type of geological formations above it.

By being aware of these considerations, you can handle pesticides in ways that will make the potential for ground water contamination less likely.

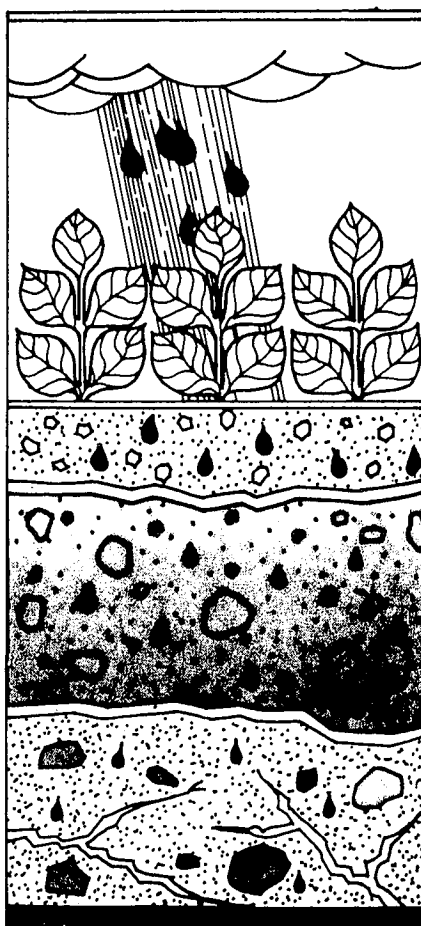

## Practices for Pesticide Users

The best way to keep from contaminating ground water is to follow labeling directions exactly. Be sure to note whether the labeling requires you to take any special steps to protect ground water. In addition, remember the following:

- Avoid the temptation to use more pesticide than the labeling directs. Overdosing will increase both the cost of pest control and the odds that the pesticide will reach ground water. Overdosing is also illegal. Keeping the use of pesticides to a minimum greatly reduces the risk of ground water contamination.

- Consider whether your application method presents any special risks. For example, soil injection of some pesticides may not be wise when ground water is close to the surface.

- Take precautions to keep pesticides from back-siphoning into your water source.

- Locate pesticide storage facilities at least 100 feet from wells, springs, sinkholes, and other sites that directly link to ground water to prevent their contamination from runoff or firefighting water.

- Whenever possible, locate mix-load sites and equipment-cleaning sites at least 100 feet from surface water or from direct links to ground water. This will help prevent back-siphoning, runoff, and spills from contaminating the water sources. If you must locate one of these work sites near a water source, use methods such as dikes, sump pits, and containment pads to keep pesticides from reaching the water.

- Do not contaminate ground water through improper disposal of unused pesticides, pesticide containers, or equipment and container rinse water. Dispose of all pesticide wastes in accordance with local, State, tribal, and Federal laws.

## Water on the Treated Surface

If there is more water on the soil than the soil can hold, the water (along with any pesticides it contains) is likely to move downward to the ground water. Prolonged heavy rain or excessive irrigation will produce excess water on the soil surface.

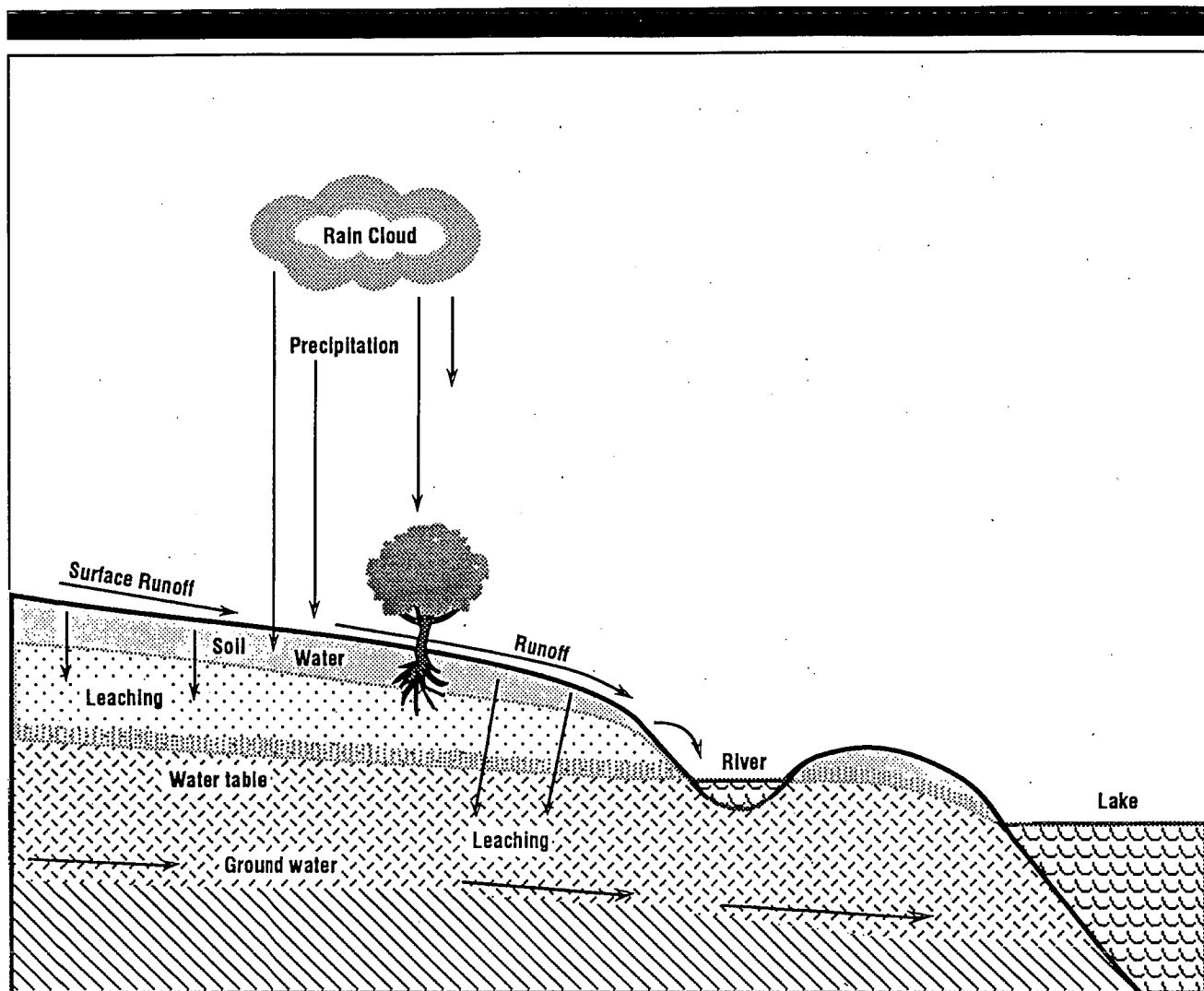

## Rain

If weather forecasts or your own knowledge of local weather signs cause you to expect heavy rain, delay outdoor handling operations — including mixing and loading, application, and disposal — to prevent wash-off, surface runoff, or leaching.

## Irrigation

Pesticide movement into ground water is affected by both the amount of water used in irrigation and how soon before or after a pesticide application the irrigation is done. If irrigation water contains pesticides, be careful to prevent it from flowing into water sources.

## Pesticide Factors

Some pesticide chemicals are more likely than others to move to ground water. Such movement depends mainly on:

- **solubility** — Some pesticides dissolve easily in water and are more likely to move into water systems.
- **adsorption** — Some pesticides become tightly attached (strongly adsorbed) to soil particles and are not likely to move out of the soil and into water systems.
- **persistence** — Some pesticides break down slowly and remain in the environment for a long time.

These factors are all related to one another. Pesticides that are most likely to move into ground

water are highly soluble, moderately to highly persistent, and are not strongly adsorbed to soil. A nonpersistent pesticide would be less likely to move to ground water, even if it is highly soluble or not strongly adsorbed to soil. A pesticide that is strongly adsorbed to soil would be less likely to move to ground water even if it is persistent.

Pesticide labeling usually does not tell you about these properties of the pesticide product. The Soil Conservation Service, Cooperative Extension Service, your trade association, or your pesticide dealer may have specific information about the characteristics of the pesticides you are using.

## Soil Factors

Soil is also an important factor in the breakdown and movement of pesticides. Your local Soil Conservation Service can help you determine the types of soil in your area and how they affect breakdown and movement. The three major soil characteristics that affect pesticides are texture, permeability, and organic matter.

**Soil texture** is an indication of the relative proportions of sand, silt, and clay in the soil. Coarse, sandy soils generally allow water to carry the pesticides rapidly downward. Finer textured soils generally allow water to move at much slower rates. They contain more clay, and sometimes organic matter, to which pesticides may cling.

**Soil permeability** is a general measure of how fast water can move downward in a particular soil. The more permeable soils must be managed carefully to keep pesticides from reaching ground water.

**Soil organic matter** influences how much water the soil can hold before it begins to move downward. Soil containing organic matter has greater ability to stop the movement of pesticides. Soils in which plants are growing are more likely to prevent pesticide movement than bare soils.

## Geology

The **distance from the soil surface to the water table** is the measure of how deep the ground water is in a given location. If the ground water is within a few feet of the soil surface, pesticides are more likely to reach it than if it is farther down. In humid areas, the water table may be only a few feet below the surface of the soil. In

arid areas, the water table may lie several hundred feet below the soil surface. The depth to the water table does not stay the same over the course of the year. It varies according to:

- the amount of rain, snow, and irrigation water being added to the soil surface,
- the amount of evaporation and plant uptake,
- whether the ground is frozen, and
- how much ground water is being withdrawn by pumping.

The Soil Conservation Service can provide you with valuable information on the geology of an area and on the potential for ground water contamination on your property.

Spring and fall generally are the times when the water table is closest to the soil surface. The water table often moves downward during the summer when evaporation and plant uptake are high and when larger than normal amounts of ground water are being used for irrigation and other hot weather needs. The water table also moves downward in winter if surface water cannot move down through the frozen soil to recharge the ground water.

The **permeability of geological layers** between the soil and ground water is also important. If surface water can move down quickly, pesticides are more likely to reach ground water. Gravel deposits are highly permeable. They allow water and any pesticides in it to move rapidly downward to ground water. Regions with limestone deposits are particularly susceptible to ground water contamination, because water may move rapidly to the ground water through caverns or "rivers" with little filtration or

chemical breakdown. On the other hand, layers of clay may be totally impermeable and may prevent most water and any pesticides in it from reaching the ground water.

**Sinkholes** are especially troublesome. Surface water often flows into sinkholes and disappears quickly into the ground water. If a pesticide is released into an area that drains to a sinkhole, even a moderate rain or irrigation may carry some of the pesticide directly to the ground water.



## The Certified Applicator's Role

Some pesticides or certain uses of some pesticides may be classified as restricted use because of ground water concerns. As a certified applicator, you have a special responsibility to handle all pesticides safely in and near use sites where ground water contamination is particularly likely. Take extra precautions when using techniques that are known to be likely to cause contamination of ground water, such as chemigation and soil injection.

When a pesticide product has been found in ground water or has characteristics that may pose a

threat of contamination of ground water, the pesticide product labeling may contain statements to alert you to the concern. Typical pesticide labeling statements include:

*This chemical has been identified in limited ground water sampling and there is the possibility that it can leach through the soil to*

*ground water, especially where soils are coarse and ground water is near the surface.*

*This product is readily decomposed into harmless residues under most use conditions. However, a combination of permeable and acidic soil conditions, moderate to heavy irrigation and/or rainfall, use of 20 or more pounds*

*per acre, and soil temperature below 50°F (10°C) at application time tend to reduce degradation and promote movement of residues to ground water. If the above describes your local use conditions and ground water in your area is used for drinking, do not use this product without first contacting (registrant's name and telephone number).*

## Protection of Endangered Species

An endangered species is a plant or animal that is in danger of becoming extinct. There are two classifications of these plants and animals in danger — “endangered species” and “threatened species.” The term “endangered species” is used here to refer to the two classifications collectively. Scientists believe that some pesticides may threaten the survival of some of America’s endangered species if they are used in the places where these plants and animals still exist.

A Federal law, the Endangered Species Act, requires the U.S. Environmental Protection Agency (EPA) to ensure that endangered species are protected from pesticides. EPA’s goal is to remove or reduce the threat that pesticide use poses to endangered species. Reaching this goal will require some limitations on pesticide use. These limitations usually will apply only in the currently occupied habitat or range of each endangered species at risk. Occasionally the limitations will apply where endangered species are being reintroduced into a habitat they previously occupied.

Habitats, sometimes called “critical habitats,” are the areas of land, water, and air space that an endangered species needs for

survival. Such areas include breeding sites; sources of food, cover, and shelter; and surround-

ing territory that gives room for normal population growth and behavior.



United States  
Environmental Protection  
Agency

201-3050  
September 1990

Pesticides And Toxic Substances (H-7506C)

### Protecting Endangered Species



The information in this pamphlet is similar to what the U.S. Environmental Protection Agency (EPA) expects to distribute once our Endangered Species Protection Program is in effect. The limitations on pesticide use are not law at this time, but are being provided now for your use in voluntarily protecting endangered and threatened species from harm due to pesticide use. We encourage you to use this information. We also welcome your comments.

The Endangered Species Act is intended to protect and promote recovery of animals and plants that are in danger of becoming extinct due to the activities of people. Under the Act, EPA must ensure that use of pesticides it registers will not result in harm to the species listed as endangered or threatened by the U.S. Fish and Wildlife Service, or to habitat critical to those species' survival. To accomplish this, the EPA expects to implement program requirements beginning in 1991. This program will protect endangered and threatened species from harm due to pesticide use.

EPA requests your comments regarding the information presented in this publication. Please drop us a line to let us know whether the information is clear and correct. Also tell us to what extent following the recommended measures would affect your typical pesticide use or productivity. This information will be considered by EPA during the final stages of program development.

Please submit comments to:  
Interim Endangered Species  
Protection Program (H7506C)  
Public Docket and Information Section  
U.S. EPA  
401 M Street, SW  
Washington, DC 20460



**About This Publication**

This publication contains a County Map showing the area within the county where pesticide use should be limited to protect listed species. These areas are identified by the map by a shaded pattern. Each shaded pattern corresponds to a species in need of protection.

The Shading Key shows the name of the species that each shaded pattern represents and describes the shaded area. The area may be described in terms of Township, Range, and Section or by giving details about the habitat of the species.

The first column of the “Table of Pesticide Active Ingredients” lists the active ingredients for which there should be limitations on use to protect certain species. The next columns are headed by the shaded pattern of the species with Codes listed underneath them.

The Code indicates the specific limitations that is necessary to protect the species. The section titled Limitations on Pesticide Use explains the code.

**Does This Information Apply To You?**

To determine whether this information applies to your use of a pesticide, review the questions below. The information applies only if you answer “yes” to both questions:

- Do you intend to use pesticides within the shaded area on the county map?
- Are any of the ingredients listed on the front panel of your pesticide product label named in the “Table of Pesticide Active Ingredients”?

If you answer “yes” to both questions, you should follow the instructions on “How to Use This Information” to determine if you should limit use of the pesticide to the protect listed species.

If you answer “no” to either question, you should follow the usage directions on the pesticide product label.

 Printed on Recycled.



## Limitations on Pesticide Use

Read all pesticide labeling carefully to find out whether the use of that product requires you to take any special steps to protect endangered species. The label may direct you to another source for the details about what you must do. When limitations do apply, they usually will be in effect only in some specific geographic locations. Use of a particular pesticide is usually limited in a particular location when:

- the site is designated as the current habitat of an endangered species, **and**
- the endangered species that uses the site might be harmed by the use of the pesticide within (or close to) its habitat.

## Habitats of Endangered Species

The U.S. Fish and Wildlife Service is responsible for identifying the current habitat or range of each endangered species. For aquatic species, the restricted habitat often will include an additional zone around the body of water to keep any drift, runoff, or leachate in the watershed from reaching the water.

The U.S. Fish and Wildlife Service is attempting to identify the habitats as accurately as possible so that pesticide use will need to be limited only in locations where it is absolutely necessary. For this reason, limitations on pesticide use may apply on one property, while a similar adjoining property may not have these limitations.

## Importance of Protecting Endangered Species

Hundreds of animals (including fish, birds, mammals, reptiles, amphibians, insects, and aquatic invertebrates) and thousands of plants have been named as endangered or threatened species under the provisions of the Endangered Species Act. Some of these animals and plants are ones that everyone knows about, such as the bald eagle. Others are tiny, little-known creatures that may rarely be seen by anyone except trained naturalists.

Regardless of the size or apparent significance of these endangered species, it is important that each is allowed to survive — mankind's well-being depends on

## Endangered Species Restriction

Under the Endangered Species Act, it is a Federal offense to use any pesticide in a manner that results in the death of a member of an endangered species. Prior to making applications, the user must determine that endangered species are not located immediately adjacent to the site to be treated. If the users are in doubt whether or not endangered species may be affected, they should contact the regional U.S. Fish and Wildlife Service Office (Endangered Specialist) or personnel of the State Fish and Game Office.

maintaining **biological diversity**. Biological diversity is the variety and differences among living things, and the complex ways they interact. Diversity is necessary for several reasons:

### Agriculture

Nearly all of today's crops started as wild species. Genes from wild species often are used to create new hybrids that have resistance to plant diseases and insects, better climatic tolerance, and higher yields. Having different varieties available is necessary insurance against devastating crop failures caused by climate extremes or major pest outbreaks.

### Medicine

Many of today's most important medicines come from obscure plant and animal species. A mold is the source of penicillin, the miracle drug; an herb is the source of quinine, a cure for malaria. Scientists are testing countless plant and animal species around the world for sources of cures for major diseases.



### Preserving choices

No one can predict which species may be essential to the future of mankind. A species that is allowed to become extinct might have been the key to stopping a global epidemic or to surviving a major climate change.

### Interdependence

The extinction of a single species can set off a chain reaction of harm to other species. The disappearance of a single kind of plant from an area, for example, may lead to the disappearance of

certain insects, higher animals, and other plants.

### Natural balance

Extinction has always been a natural part of an ever-changing process. During most of history, species have formed at a rate greater than the rate of extinctions. Now, however, it appears that human activity is greatly speeding up the rate of extinctions. People, plants, and animals live together in a delicate balance; the disappearance of species could easily upset that balance.

### Stability

The more diversity that exists in an ecosystem, the more stable it is likely to be. There is less likelihood of huge swings in populations of particular organisms. There is also less likelihood of devastation from the introduction of a new species from outside the system.

### The Certified Applicator's Role

Pesticides have the potential to harm living organisms, including endangered species:

- Pesticides can kill endangered plants and animals directly.
- Pesticides in the habitat of the endangered organisms can disrupt or destroy their sources of food and shelter.
- Pesticide application, drift, runoff, and leachate can contaminate water ingested by or inhabited by endangered organisms.
- Some pesticides can build up to dangerous levels in endangered predators that feed on plants or animals exposed to pesticides.

As a certified applicator, you have a clearly defined legal responsibility to protect endangered species against the hazards posed by pesticides. Careful use of pesticides in and around the key habitat areas will help these fragile plants and animals to survive, and it also may prevent some important pesticides from being removed from the market.

Typical pesticide labeling statements that alert you to concerns about endangered species include:

*Under the Endangered Species Act, it is a Federal offense to use any pesticide in a manner that results in the death of a member of an endangered species. Prior to making applications, the user must determine that endangered species are not located in or immediately adjacent to the site to be treated. If the users are in doubt whether or not endangered species may be affected, they should contact the regional U.S. Fish and Wildlife Service office (Endangered Species specialist) or personnel of the State Fish and Game office.*

*Endangered Species Restrictions:  
For Aerial Application — Do not use within 100 yards of aquatic habitats. For Ground Application — Do not use within 20 yards of aquatic habitats.*

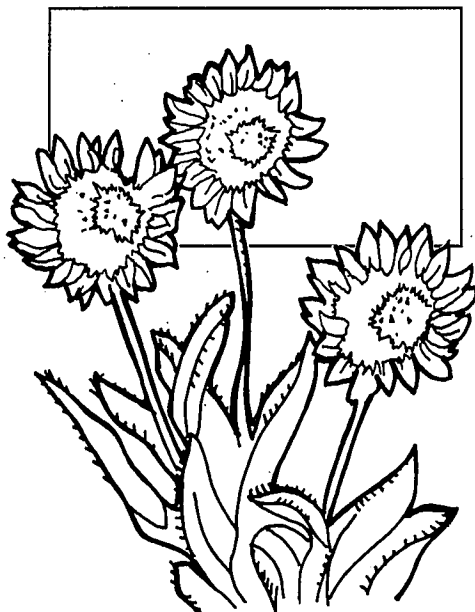



## Know the Law

The Endangered Species Act (ESA) is a Federal law administered by the Fish and Wildlife Service (FWS) of the Department of the Interior. The ESA makes it illegal to kill, harm, or collect endangered or threatened wildlife or fish or to remove endangered or threatened plants from areas under Federal jurisdiction. It also requires other Federal agencies to ensure that any action they carry

out or authorize is not likely to jeopardize the continued existence of any endangered or threatened species, or to destroy or adversely modify its critical habitat. As a result, EPA must ensure that no registered pesticide use is likely to jeopardize the survival of any endangered or threatened species.

The FWS has the authority to designate land and freshwater species as endangered or threat-

ened and to identify their current habitat or range. The National Marine Fisheries Service has the same authority for marine species.

The FWS has the authority to prosecute persons, including pesticide users, who harm endangered or threatened species. In addition, EPA enforcement personnel have the authority to ensure that pesticide users observe labeling restrictions.

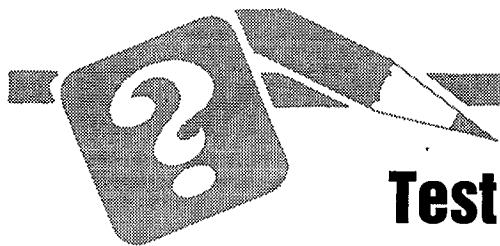

## Test Your Knowledge

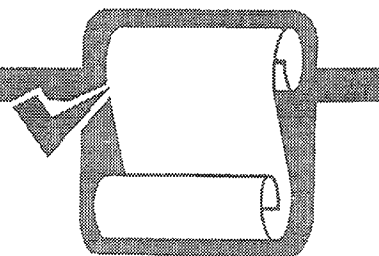

**Q.** Which pesticide handling activities pose a threat to ground water or endangered species?

**A.** All handling activities may pose a threat, including mixing, loading, applying, equipment cleaning, storage, transportation, disposal, and spill cleanup.

**Q.** Why is the location of your pesticide use site the main factor that determines whether you must take special action to protect endangered species or ground water?

**A.** These special limitations on pesticide use are usually in effect only in locations where endangered species live or are being

introduced and in areas where ground water is especially likely to be contaminated. Unless your pesticide use site is in one of these places, the special restrictions do not apply to you.

**Q.** How will you know if you must take special action to protect endangered species or ground water?

**A.** The pesticide labeling will tell you if special measures are necessary, but it may not contain the detailed instructions that you must follow. The labeling may instruct you to get these from another source.

**Q.** What are some factors that determine whether pesticides will reach ground water?

**A.** The factors include: practices followed by pesticide users; presence or absence of water on the surface of the site where the pesticides are released; chemical characteristics of the pesticides; type of soil in the site where the pesticides are released; location of the ground water — its distance from the surface and the type of geological formations above it.

**Q.** How can you help to prevent pesticides from reaching ground water?

**A.** Avoid using more pesticide than the labeling directs; avoid application methods that present special risks; keep pesticides from back-siphoning into your water source; locate pesticide storage



facilities at least 100 feet from wells, springs, sinkholes, and other sites that directly link to ground water; locate mix-load sites and equipment-cleaning sites at least 100 feet from surface water or from direct links to ground water or take precautions to protect those sites; dispose of unused pesticides, pesticide containers, and equipment and container rinse water correctly.

**Q. Explain why the amount of water on the surface of the soil at the pesticide use site is an important factor in ground water contamination.**

**A.** If there is more water on the soil than the soil can hold, the water (along with any pesticides it contains) is likely to move downward to the ground water.

**Q. Explain how the solubility, adsorption, and persistence of a pesticide affect its ability to move into ground water.**

**A.** *Solubility* — Some pesticides dissolve easily in water and are more likely to move into water systems.

*Adsorption* — Some pesticides become tightly attached (strongly

adsorbed) to soil particles and are not likely to move out of the soil and into water systems.

*Persistence* — Some pesticides do not break down quickly and remain in the environment for a long time, so are more likely to move into ground water.

**Q. What types of soil slow the movement of pesticides into ground water? What types permit rapid movement?**

**A.** Soils that are fine-textured and contain organic matter slow the downward movement of water containing pesticides. Coarse, sandy soils generally allow water to carry pesticides rapidly downward.

**Q. What geologic factors affect the movement of pesticides into ground water?**

**A.** Distance to ground water, permeability of geologic layers, and the presence or absence of sinkholes.

**Q. What is an endangered species?**

**A.** An endangered species is a plant or animal that is in danger of becoming extinct.

**Q. What is a habitat?**

**A.** A habitat is the area of land, water, and air space that an endangered species needs for survival. Such areas include breeding sites; sources of food, cover, and shelter; and enough surrounding territory to give room for normal population growth and behavior.

**Q. What is biological diversity?**

**A.** Biological diversity is the variety and differences among living things, and the complex ways they interact.

**Q. How can pesticides harm endangered species?**

**A.** Pesticides may harm endangered species by direct contact; by disrupting or destroying sources of food and shelter; by contaminating water ingested by or inhabited by endangered organisms; by building up to dangerous levels in endangered predators that feed on plants or animals exposed to pesticides.



---

# Harmful Effects and Emergency Response

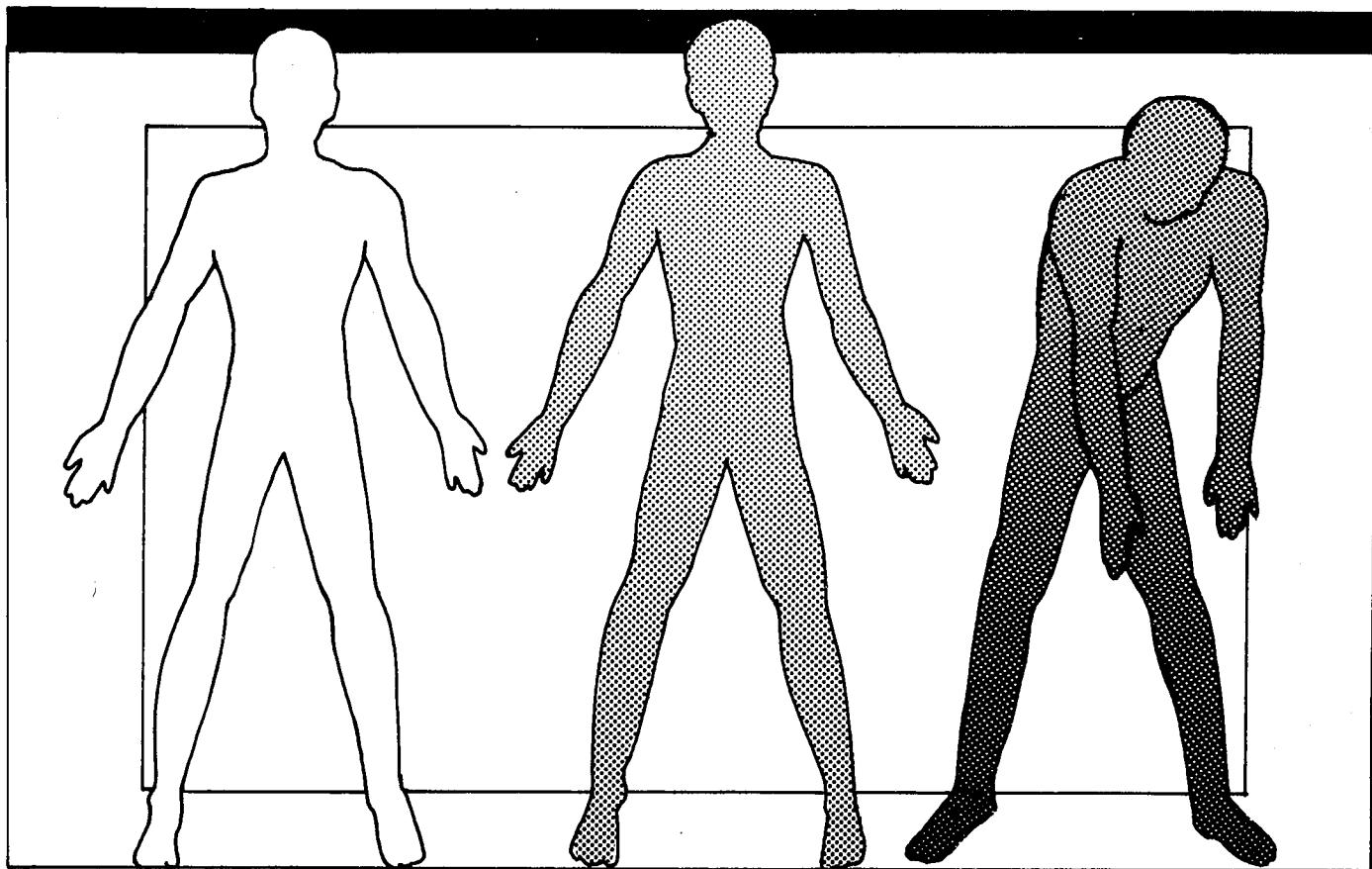

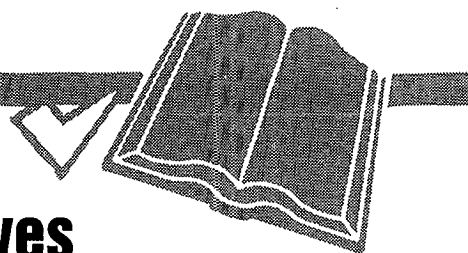
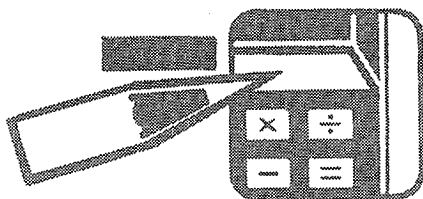

## Learning Objectives

After you complete your study of this unit, you should be able to:

- Explain the concepts of hazard, exposure, and toxicity and how they relate to one another.
- List the four routes by which your body can be exposed to pesticides, and name the route that should be of most concern to you.

- List three factors that determine how quickly pesticides will be absorbed through your skin.
- Explain the three main types of harmful effects that pesticides can cause in humans.
- Describe how to avoid harmful effects from pesticides.
- Describe some general signs and symptoms of pesticide poison-

ing and of pesticide irritation effects.

- Describe appropriate first aid for pesticide exposures.
- Define “heat stress” and describe some signs and symptoms of heat stress.
- Describe appropriate first aid for heat stress.

## Terms To Know

**Active ingredients** — The chemicals in a pesticide product that control the target pest.

**Carrier** — The primary material used to allow a pesticide to be dispersed effectively; for example, the talc in a dust formulation, the water mixed with a wettable powder before a spray application, or the air that disperses the pesticide in an air blast application.

**Diluent** — Anything used to dilute a pesticide.

**Dilute** — To make less concentrated.

**Drift** — Pesticide movement away from the release site in the air.

**Formulation** — Pesticide product as sold, usually a mixture of active and inert ingredients.

**Inert ingredients** — Inactive components of a pesticide formulation that are used to dilute the pesticide or to make it safer, more effective, easier to measure, mix, and apply, and more convenient to handle.

**Labeling** — The pesticide product label and other accompanying materials that contain directions that pesticide users are legally required to follow.

**Personal protective equipment (PPE)** — Devices and clothing worn to protect the human body from contact with pesticides or pesticide residues.

**Pesticide handling** — Directly working with pesticides, such as during mixing, loading, transporting, storing, disposing, and applying, or working on pesticide equipment.

**Precautionary statements** — Pesticide labeling statements that alert you to possible hazards from use of the pesticide product and that sometimes indicate specific actions to take to avoid the hazards.

**Solvent** — A liquid, such as water, kerosene, xylene, or alcohol, that will dissolve a pesticide (or other substance) to form a solution.

**M**ost pesticides are designed to harm or kill pests. Because some pests have systems similar to the human system, some pesticides also can harm or kill humans. Fortunately, humans usually can avoid harmful effects by avoiding being exposed to pesticides.

Humans may be harmed by pesticides in two ways: they may be **poisoned** or **injured**. Pesticide **poisoning** is caused by pesticides that harm internal organs or other systems inside the body. Pesticide-related **injuries** usually are caused

by pesticides that are external irritants.

Pesticides that are chemically similar to one another cause the same type of harmful effects to humans. These effects may be mild or severe, depending on the pesticide involved and the amount of overexposure. But the **pattern** of illness or injury caused by each chemical group is usually the same. Some pesticide chemical families can cause both external irritation injuries and internal poisoning illnesses.

Some pesticides are highly toxic to humans; only a few drops in the mouth or on the skin can

cause extremely harmful effects. Other pesticides are less toxic, but too much exposure to them will cause harmful effects also. A good equation to remember is:

$$\text{Hazard} = \text{Toxicity} \times \text{Exposure}$$

**Hazard** is the risk of harmful effects from pesticides. Hazard depends on both the **toxicity** of the pesticide and the **exposure** you will receive in any situation.

## Exposure

When a pesticide comes into contact with a surface or an organism, that contact is called a pesticide exposure. For humans, a

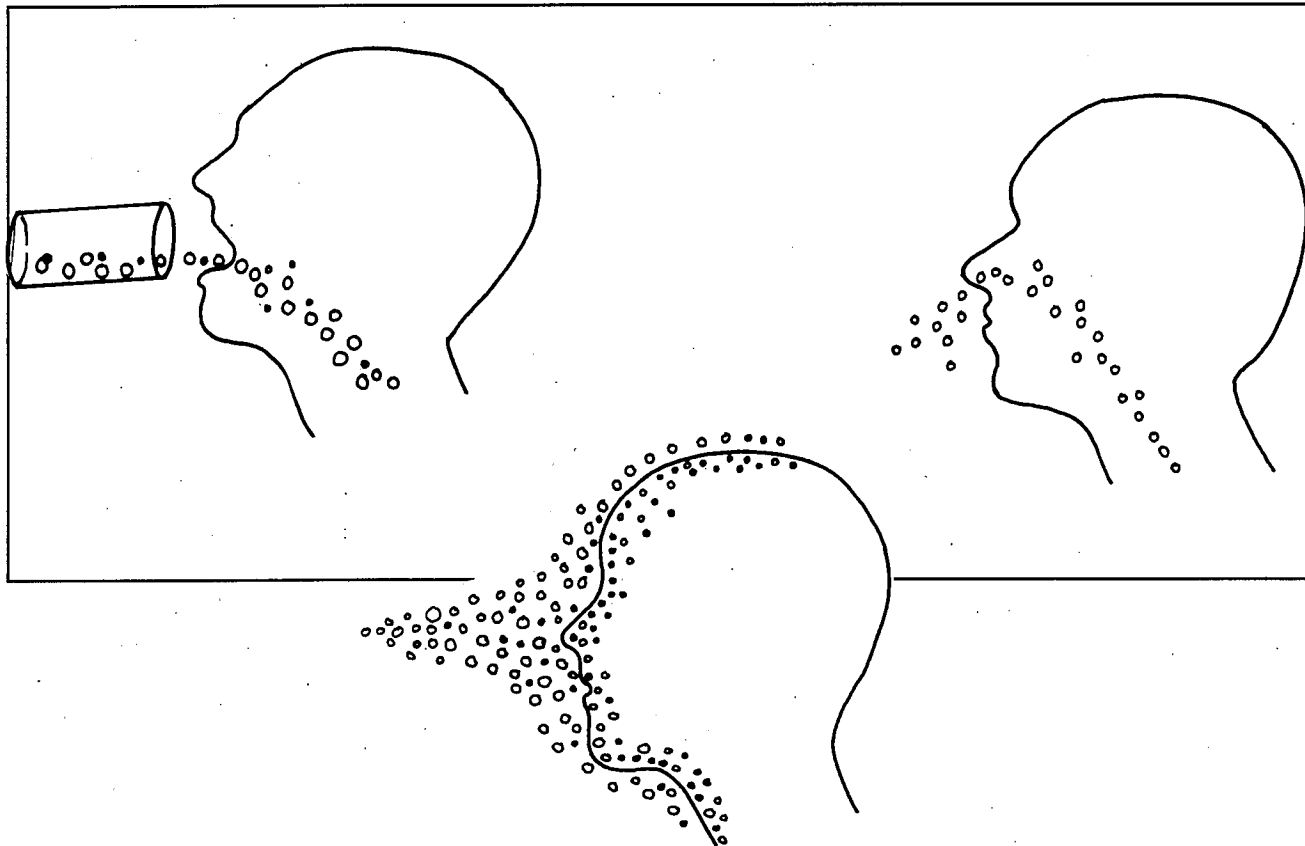

pesticide exposure means getting pesticides in or on the body. The toxic effect of a pesticide exposure depends on how much pesticide is involved and how long it remains there.

## Types of Exposures

Pesticides contact your body in four main ways:

- oral exposure (when you swallow a pesticide),
- inhalation exposure (when you inhale a pesticide),
- ocular exposure (when you get a pesticide in your eyes), or
- dermal exposure (when you get a pesticide on your skin).

## Avoiding Exposure

Avoiding and reducing exposures to pesticides will reduce the harmful effects from pesticides. You can avoid exposures by using safety systems, such as closed systems and enclosed cabs, and you can reduce exposures by wearing appropriate personal protective equipment, washing exposed areas often, and keeping your personal protective equipment clean and in good operating condition.

In most pesticide handling situations, the skin is the part of the body that is most likely to receive exposure. Evidence indicates that about 97 percent of all body exposure that happens during pesticide spraying is by contact with the skin. The only time that inhalation is a greater hazard than skin contact is when you are working in a poorly ventilated enclosed space and are using a fumigant or other pesticide that is highly toxic by the inhalation route.

The amount of pesticide that is absorbed through your skin (and eyes) and into your body depends on:

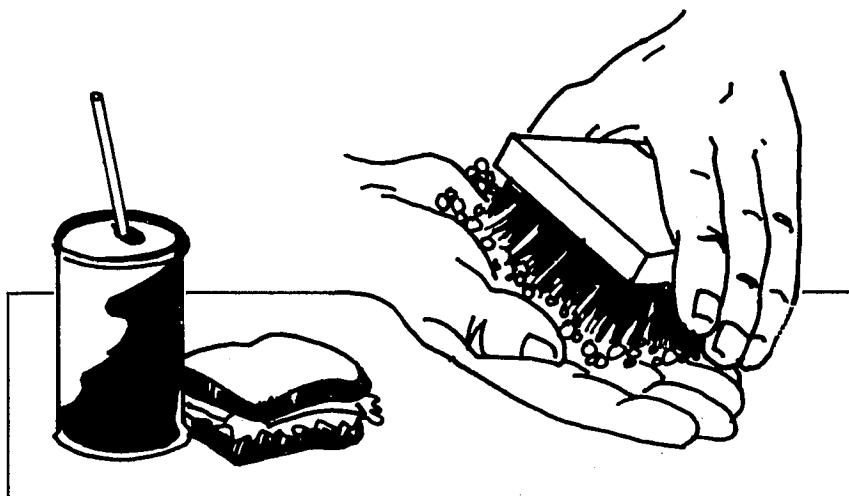

- the pesticide itself and the material used to dilute the pesticide. Emulsifiable concentrates, oil-based liquid pesticides, and oil-based diluents (such as xylene) are, in general, absorbed most readily. Water-based pesticides and dilutions (such as wettable and soluble powders and dry flowables) usually are absorbed less readily than the oil-based liquid formulations but more readily than dry formulations. Dusts, granules, and other dry formulations are not absorbed as readily as liquids.

- the area of the body exposed. The genital area tends to be the most absorptive. The scalp, ear canal, and forehead are also highly absorptive.

- the condition of the skin exposed. Cuts, abrasions, and skin rashes allow absorption more readily than intact skin. Hot, sweaty skin will absorb more pesticide than dry, cool skin.

## Causes of Exposure

One of the best ways to avoid pesticide exposures is to avoid situations and practices where exposures commonly occur.

**Oral exposures** often are caused by:

- not washing hands before eating, drinking, smoking, or chewing,

- mistaking the pesticide for food or drink,
- accidentally applying pesticides to food, or
- splashing pesticide into the mouth through carelessness or accident.

**Inhalation exposures** often are caused by:

- prolonged contact with pesticides in closed or poorly ventilated spaces,
- breathing vapors from fumigants and other toxic pesticides,
- breathing vapors, dust, or mist while handling pesticides without appropriate protective equipment,
- inhaling vapors present immediately after a pesticide is applied; for example, from drift or from reentering the area too soon, and
- using a respirator that fits poorly or using an old or inadequate filter, cartridge, or canister.

**Dermal exposures** often are caused by:

- not washing hands after handling pesticides or their containers,
- splashing or spraying pesticides on unprotected skin or eyes,
- wearing pesticide-contaminated clothing (including boots and gloves),
- applying pesticides (or flagging) in windy weather,
- wearing inadequate personal protective equipment while

handling pesticides, and

- touching pesticide-treated surfaces.

**Eye exposures** often are caused by:

- splashing or spraying pesticides in eyes,
- applying pesticides in windy weather without eye protection,
- rubbing eyes or forehead with contaminated gloves or hands, and
- pouring dust, granule, or powder formulations without eye protection.

## Toxicity

Toxicity is a measure of the ability of a pesticide to cause harmful effects. Toxicity depends on:

- type and amount of active ingredient(s),
- type and amount of carrier or solvent ingredient(s),
- type and amount of inert ingredient(s), and
- type of formulation, such as dust, granule, powder, or emulsifiable concentrate.

The toxicity of a particular pesticide is measured by subjecting laboratory animals (usually rats, mice, rabbits, and dogs) or tissue cultures to different dosages of the active ingredient and of the formulated product over various time periods. These toxicity studies help to estimate the risk that the pesticide may cause harmful effects in humans. However, some people react more severely or more mildly than estimated. Be alert to your body's reaction to the pesticides you are handling. Some people seem to be especially sensitive to individual pesticides or to groups of similar pesticides.

You may have a choice of pesticides for a particular pest problem. One of the factors you

should consider is how toxic each possible choice is to persons who will use it or be exposed to it.

## Harmful Effects

Pesticides can cause three types of harmful effects: acute effects, delayed effects, and allergic effects.

### Acute Effects

Acute effects are illnesses or injuries that may appear immediately after exposure to a pesticide (usually within 24 hours). Studying a pesticide's relative capability of causing acute effects has been the main way to assess and compare how toxic pesticides are. Acute effects can be measured more accurately than delayed effects, and they are more easily diagnosed than effects that do not appear until long after the exposure. Acute effects usually are obvious and often are reversible if appropriate medical care is given promptly.

Pesticides cause four types of acute effects:

- acute oral effects,
- acute inhalation effects,
- acute dermal effects,
- acute eye effects.

### Acute oral effects

Your mouth, throat, and stomach can be burned severely by some pesticides. Other pesticides that you swallow will not burn your digestive system, but will be absorbed and carried in your blood throughout your body and may cause you harm in various ways. For some pesticides, swallowing even a few drops from a splash or wiping your mouth with a contaminated glove can make you very ill or make it difficult to eat and drink and get nourishment.

### Acute inhalation effects

Your entire respiratory system can be burned by some pesticides, making it difficult to breathe. Other pesticides that you inhale may not harm your respiratory system, but are carried quickly in your blood throughout your whole body where they can harm you in various ways.

### Acute dermal and skin irritation effects

Contact with some pesticides will harm your skin. These pesticides may cause your skin to itch, blister, crack, or change color. Other pesticides can pass through your skin and eyes and get into your body. Once inside your body, these pesticides are carried throughout your system where they can cause you harm in various ways.

### Acute eye effects

Some pesticides that get into your eyes can cause temporary or permanent blindness or severe irritation. Other pesticides may not irritate your eyes, but pass through your eyes and into your body. These pesticides can travel throughout your body, causing you harm in various ways.

### Delayed Effects

Delayed effects are illnesses or injuries that do not appear immediately (within 24 hours) after exposure to a pesticide or combination of pesticides. Often the term "chronic effects" is used to describe delayed effects, but this term is applicable only to certain types of delayed effects.

Delayed effects may be caused by:

- **repeated exposures** to a pesticide, a pesticide group, or a combination of pesticides over a long period of time, or

■ a **single exposure** to a pesticide (or combination of pesticides) that causes a harmful reaction that does not become apparent until much later.

Some pesticides cause delayed effects only with **repeated exposure** over a period of days, months, or even years. For example, if a rat eats a large amount of the pesticide cryolite at one time, the pesticide passes through the rat's system quickly and is eliminated without harmful effects. However, if the rat regularly eats small amounts of cryolite, it soon becomes ill and dies. Cryolite does not readily dissolve in water. The small amount of pesticide that is absorbed into the rat's system from a one-time exposure is not enough to cause illness. But if that same small amount is absorbed day after day, enough poison will be absorbed into the rat's system to cause illness and death.

Sometimes repeated exposures to a pesticide or family of pesticides will result in a delayed effect, but a larger exposure will cause an acute effect. Organophosphate and carbamate pesticides inhibit a chemical, called cholinesterase, in the nervous system of humans. A large exposure causes immediate acute illness. Smaller exposures cause no apparent problem at first. They inhibit the cholinesterase, but not enough to cause immediate illness. Small, repeated exposures to these pesticides over several days or weeks may greatly reduce cholinesterase levels in the body. At that point, even a small exposure to a pesticide with relatively low cholinesterase-inhibiting properties may trigger severe illness.

A person who is repeatedly exposed to two or more specific chemicals may become ill even

## Typical Precautionary Statements on Pesticide Labeling

|                         | Highly Toxic   | Moderately Toxic  | Slightly Toxic  |
|-------------------------|--|---|---|
| <b>Acute Oral</b>       | "Fatal if swallowed," or "Can kill you if swallowed."  | "Harmful or fatal if swallowed," or "May be fatal if swallowed."  | "Harmful if swallowed," or "May be harmful if swallowed."   |
| <b>Acute Inhalation</b> | "Poisonous if inhaled," or "Can kill you if breathed," combined with the statement "Do not breathe dusts, vapors, or spray mist."          | "Harmful or fatal if inhaled," or "May be fatal if breathed," followed by a statement such as "Do not breathe dusts, vapors, or spray mist."          | "Harmful if inhaled," or "May be harmful if breathed," combined with the statement "Avoid breathing dusts, vapors, or spray mist."          |
| <b>Acute Dermal</b>     | "Fatal if absorbed through the skin," or "Can kill you by skin contact," combined with the statement "Do not get on skin or clothing."     | "Harmful or fatal if absorbed through the skin," or "May be fatal by skin contact," followed by a statement such as "Do not get on skin or clothing." | "Harmful if absorbed through skin," or "May be harmful by skin contact," combined with the statement "Avoid contact with skin or clothing." |
| <b>Skin Irritation</b>  | "Corrosive — causes severe skin burns," combined with the statement "Do not get on skin."  | "Causes skin irritation," or "Causes skin burns," followed by a statement such as "Do not get on skin."   | "May irritate skin," combined with the statement "Avoid contact with skin."   |
| <b>Eye Irritation</b>   | "Corrosive — causes irreversible eye damage," or "Causes severe eye burns or blindness," combined with the statement "Do not get in eyes." | "Causes eye irritation," or "Causes eye burns," followed by a statement such as "Do not get in eyes."   | "May irritate eyes," combined with the statement "Avoid contact with eyes."   |



though any one of the chemicals alone would have had no harmful health impact. Some organophosphate pesticides have been shown to have this effect when they are used in combination.

In some cases, a **single exposure** to a pesticide (or combination of pesticides) could adversely affect the exposed person's health after a period of time. For example, large exposures to paraquat, a herbicide, may cause severe or fatal lung injury that does not appear for 3 to 14 days after the initial exposure. After an exposure, paraquat slowly builds up in the lungs and destroys lung cells.

Some kinds of harmful effects may not occur unless a certain set of circumstances is present. These effects can occur after the first exposure, but the likelihood is small. Continuous or frequent exposures over a long period of time make it more likely that all the necessary factors will be present. Some genetic changes that result in the development of cancer or other delayed effects are in this category.

Types of delayed effects include:

- chronic effects,
- developmental and reproductive effects, and
- systemic effects.

### Chronic effects

Chronic effects are illnesses or injuries that appear a long time, usually several years, after exposure to a pesticide. Some delayed effects that are suspected to result from pesticides' chronic toxicity include:

- production of tumors (oncogenic effect),
- production of malignancy or cancer (carcinogenic effect),

■ changes in the genes or chromosomes (mutagenic effect). Typical precautionary statements on pesticide labeling include:

*Cancer Hazard Warning Statement: This product contains an ingredient which has been determined to cause tumors in laboratory animals.*

*NOTE: This product has been shown to cause cancer in laboratory animals.*

*The use of this product may be hazardous to your health. This product contains an ingredient which has been determined to cause tumors in laboratory animals.*

### Developmental and reproductive effects

A **developmental effect** is an injury or illness that occurs to a fetus in the womb of a woman who has been exposed to a pesticide(s). These effects include:

- birth defects (teratogenic effect), and
- illness or death (miscarriage or stillbirth) to a fetus (fetotoxic effect).

A **reproductive effect** is an injury to the reproductive system of exposed men or women. These effects include:

- infertility or sterility in men or women, and
- impotence in men.

Some developmental or reproductive effects are thought to occur immediately after exposure to a pesticide or combination of pesticides, but they may not be apparent for some time after the exposure. For example, a birth defect may be seen only after the birth of a child, which may be several months after the exposure.

Other developmental or reproductive effects are thought to result from repeated exposures to a pesticide or combination of pesticides over a period of time.

A typical precautionary statement on pesticide labeling is:

*This product may be hazardous to your health. This product has been determined to cause birth defects in laboratory animals.*

### Systemic effects

A delayed systemic effect is an illness or injury to a system in the body that does not appear immediately (within 24 hours) after exposure to a pesticide or combination of pesticides. Such effects include:

- blood disorders (hemotoxic effects), such as anemia or an inability to coagulate,
- nerve or brain disorders (neurotoxic effects), such as paralysis, nervous excitation, behavioral changes, tremor, blindness, and brain damage,
- skin disorders, such as rash, irritation, discoloration, and ulceration,
- lung and respiratory disorders, such as emphysema and asthma,
- liver and kidney disorders, such as jaundice and kidney failure.

Typical precautionary statements on pesticide labeling include:

*May produce kidney and liver damage upon prolonged exposure.*

*Inhalation may cause delayed lung, nerve, or brain injury.*

*Liquid or vapor may cause serious skin or eye injury which may have a delayed onset.*

## Determining delayed effects

Because of the time delay between the exposure and the observable effect, and because many other types of exposures may have occurred during the delay, it is sometimes hard to identify the cause of a delayed effect. Although some pesticides may cause delayed effects in laboratory animals, further studies are needed to determine whether these pesticides will affect humans the same way.

When there is clear evidence that a pesticide may cause chronic, developmental, reproductive, or systemic effects in humans, the Environmental Protection Agency will determine what steps are appropriate to reduce or eliminate the risk. Such actions include:

- removing the pesticide from use,
- requiring label warning statements about the possible effect,
- requiring specific personal protective equipment or safety systems during handling of the pesticide,
- requiring changes in dosages, method or frequency of application, and waiting times before entry or harvest/slaughter/grazing,
- restricting the use to certified applicators.

## Avoiding delayed effects

Scientists, pesticide manufacturers, and the Environmental Protection Agency cannot yet be sure what the delayed effects of too much exposure to individual pesticides or combinations of pesticides may be. It may be years before there are clear answers on the effects of all the pesticides and combinations of pesticides in use today. Meanwhile, it makes good sense to reduce your exposure to all pesticides as much as possible.

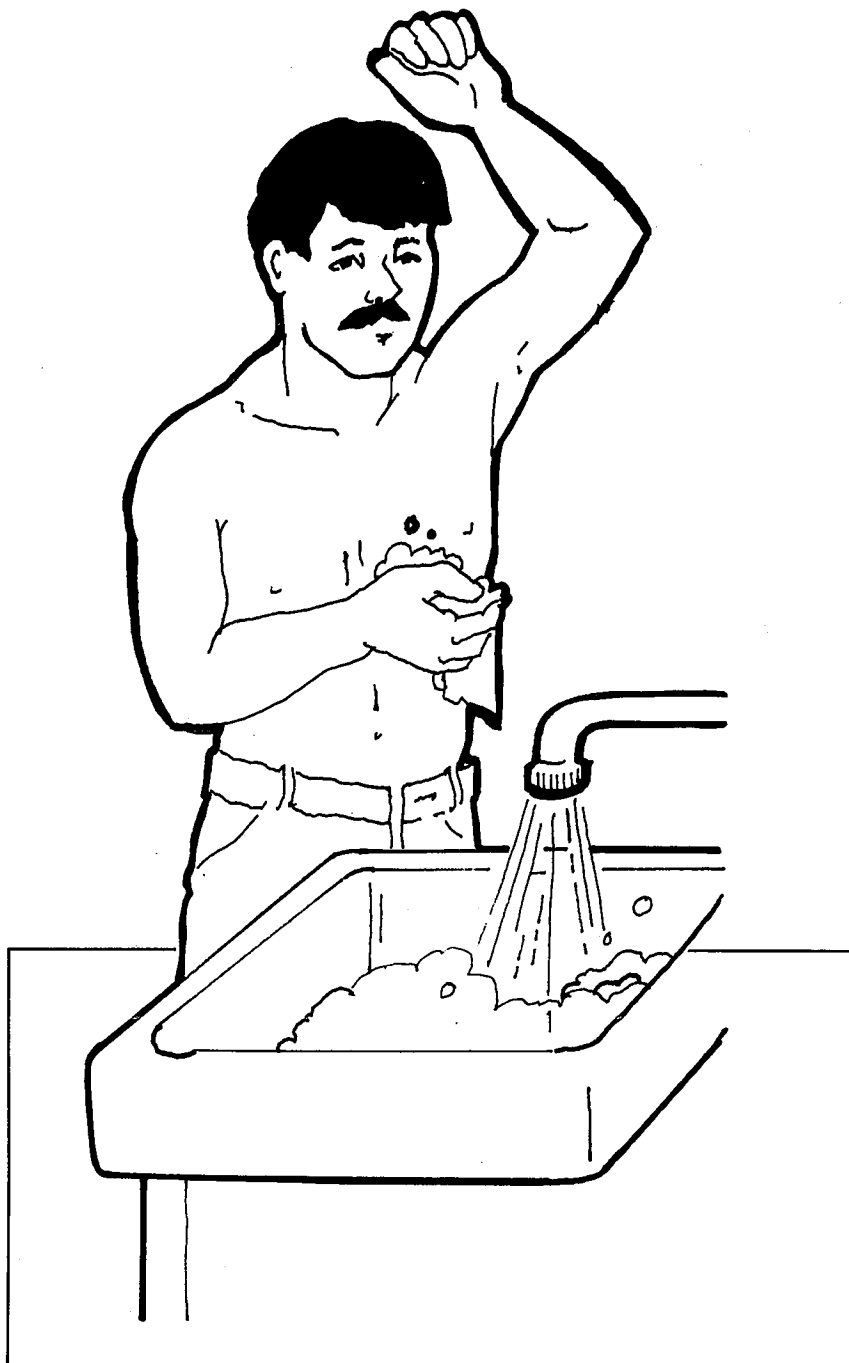

## Allergic Effects

**Allergic effects** are harmful effects that some people develop in reaction to substances that do not cause the same reaction in most other people. Allergic reactions are not thought to occur during a person's first exposure to a substance. The first exposure

causes the body to develop a repelling response to that substance. A later (the second, third, or more) exposure results in the allergic response. This process is called **sensitization**, and substances that cause people to become allergic to them are known as **sensitizers**.

Certain substances cause many people to develop an allergic reaction. Poison ivy, for example, causes a severe skin rash in many people. Other substances cause allergic reactions in only a few people. Turfgrass, for example, causes a severe skin rash in relatively few people.

### Types of allergic effects

Some people are sensitized to certain pesticides. After being exposed once or a few times without effect, they develop a severe allergy-like response upon later exposures. These allergic effects include:

- systemic effects, such as asthma or even life-threatening shock,
- skin irritation, such as rash, blisters, or open sores, and
- eye and nose irritation, such as itchy, watery eyes and sneezing.

Unfortunately, there is no way to tell which people may develop allergies to which pesticides. However, certain people seem to be more chemically sensitive than others. They develop an allergic response to many types of chemicals in their environment. These persons may be more likely to develop allergies to pesticides.

Typical precautionary statements on pesticide labeling include:

*This product may produce temporary allergic side effects characterized by redness of the eyes, mild bronchial irritation, and redness or rash on exposed skin areas. Persons having allergic reaction should contact a physician.*

*May be a skin sensitizer.*

*The active ingredient may cause skin sensitization reactions in certain individuals.*

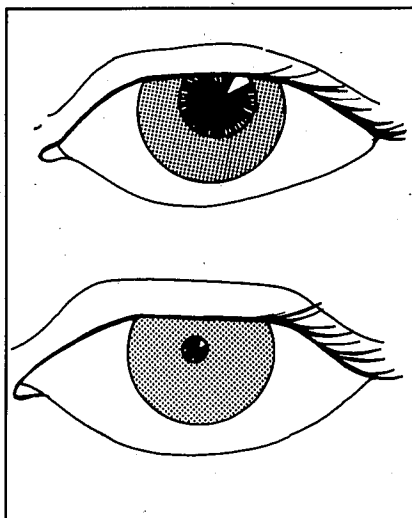

### Avoiding allergic effects

Depending on how severe the allergic reaction is, persons with allergies to certain pesticides may have to stop handling or working around those pesticides. They may be unable to tolerate even slight exposures. Sometimes persons with allergies to certain pesticides can continue to work in situations where those pesticides are present by reducing their exposure to them.

## Signs and Symptoms of Harmful Effects

Watch for two kinds of clues to pesticide-related illness or injury. Some clues are feelings that only the person who has been poisoned can notice, such as nausea or headache. These are **symptoms**. Others clues, like vomiting or fainting, can be noticed by someone else. These are **signs** you should know:

- what your own symptoms might mean, and
- what signs of poisoning to look for in your coworkers and others who may have been exposed.

Many of the signs and symptoms of pesticide poisoning are similar to signs and symptoms of other illnesses you might experi-

ence, such as the flu or even a hangover. If you have been working with pesticides and then develop suspicious signs and symptoms, call your physician or poison control center. Only a physician can diagnose pesticide poisoning injuries.

#### External irritants cause:

- redness, blisters, rash, and/or burns on skin, and
- swelling, a stinging sensation, and/or burns in eyes, nose, mouth, and throat.

#### Pesticide poisoning may cause:

- nausea, vomiting, diarrhea, and/or stomach cramps,
- headache, dizziness, weakness, and/or confusion,
- excessive sweating, chills, and/or thirst,
- chest pains,
- difficult breathing,
- cramps in your muscles or aches all over your body.

### Telltale Signs or Symptoms

Poisoning by some pesticide chemical families results in distinctive signs that help others to recognize the cause of the poisoning. Organophosphate and n-methyl carbamate poisoning, for example, is often identified by the presence of very small (pinpoint) pupils in the victim's eyes. Poisoning by pesticides containing arsenic or phosphorus is often identified by a garlic odor on the victim's breath.

Ask your physician or poison control center to obtain the latest edition of "Recognition and Management of Pesticide Poisonings" by Donald P. Morgan, M.D., Ph.D. It is available through the U.S. Environmental Protection Agency or from the U.S. Government Printing Office. Many physicians have not been trained

to recognize and treat pesticide poisonings or injury and may rarely see such cases.

## Be Informed

You should know the kinds of harmful effects most likely to be caused by the pesticides you use. The appendix, "Effects of Pesticides on the Human Body," contains a guide to help you judge how the products you are using might be expected to affect you. The chart lists the major groups of pesticides. For each group, it tells:

- the action of the poison on the human system,
- acute poisoning (systemic) effects,
- acute irritation effects,
- delayed or allergic effects,
- type of pesticide.

## Responding to a Poisoning Emergency

Get medical advice quickly if you or any of your fellow workers have unusual or unexplained symptoms starting at work or later the same day. Do not let yourself or anyone else get dangerously sick before calling your physician or going to a hospital. It is better to be too cautious than too late. Take the pesticide container (or the labeling) to the physician. Do not carry the pesticide container in the passenger space of a car or truck.

## First Aid for Pesticide Poisoning

The best first aid in pesticide emergencies is to stop the source of pesticide exposure as quickly as possible. First aid is the initial effort to help a victim while medical help is on the way. If you are alone with the victim, make

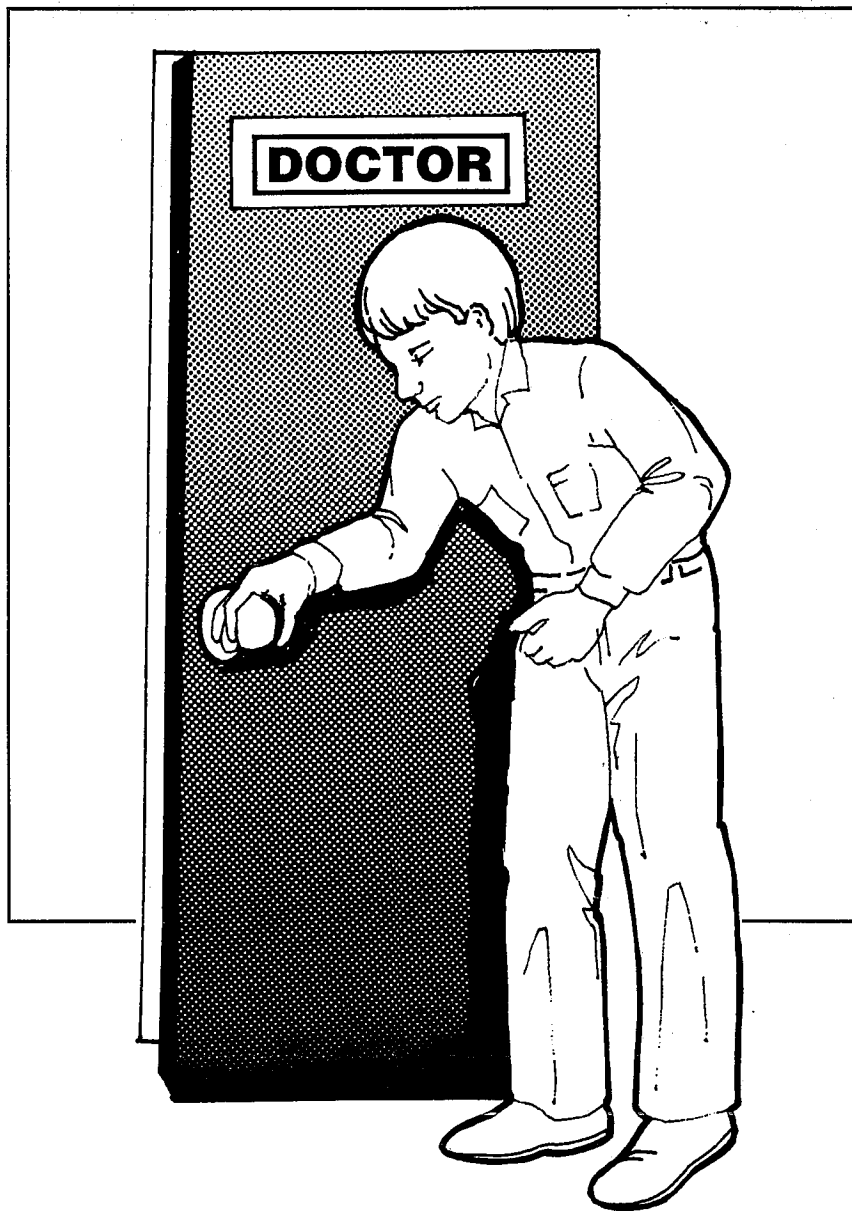

sure the victim is breathing and is not being further exposed to the pesticide before you call for emergency help. Apply artificial respiration if the victim is not breathing. Do not become exposed to the pesticide yourself while you are trying to help.

In an emergency, look at the pesticide labeling, if possible. If it gives specific first aid instructions, follow those instructions carefully. If labeling instructions are not available, follow these general guidelines for first aid:

### Pesticide on skin:

- Drench skin and clothing with plenty of water. Any source of relatively clean water will serve. If possible, immerse the person in a pond, creek, or other body of water. Even water in ditches or irrigation systems will do, unless you think they may have pesticides in them.
- Remove personal protective equipment and contaminated clothing.
- Wash skin and hair thoroughly with a mild liquid detergent and water. If one is available, a shower

is the best way to completely and thoroughly wash and rinse the entire body surface.

- Dry victim and wrap in blanket or any clean clothing at hand. Do not allow to become chilled or overheated.
- If skin is burned or otherwise injured, cover immediately with loose, clean, dry, soft cloth or bandage.
- Do not apply ointments, greases, powders, or other drugs in first aid treatment of burns or injured skin.

#### **Pesticide in eye:**

- Wash eye quickly but gently.
- Use an eyewash dispenser, if available. Otherwise, hold eyelid open and wash with a gentle drip of clean running water positioned so that it flows across the eye rather than directly into the eye.
- Rinse eye for 15 minutes or more.
- Do not use chemicals or drugs in the rinse water. They may increase the injury.

#### **Inhaled pesticide:**

- Get victim to fresh air immediately.
- If other people are in or near the area, warn them of the danger.
- Loosen tight clothing on victim that would constrict breathing.
- Apply artificial respiration if breathing has stopped or if the victim's skin is blue. If pesticide or vomit is on the victim's mouth or face, avoid direct contact and use a shaped airway tube, if available, for mouth-to-mouth resuscitation.

#### **Pesticide in mouth or swallowed:**

- Rinse mouth with plenty of water.
- Give victim large amounts (up to 1 quart) of milk or water to drink.



- Induce vomiting only if instructions to do so are on the labeling.

#### **Procedure for inducing vomiting:**

- Position victim face down or kneeling forward. Do not allow victim to lie on his back, because the vomit could enter the lungs and do additional damage.
- Put finger or the blunt end of a spoon at the back of victim's throat or give syrup of ipecac.
- Do not use salt solutions to induce vomiting.

#### **Do not induce vomiting:**

- If the victim is unconscious or is having convulsions.
- If the victim has swallowed a corrosive poison. A corrosive poison is a strong acid or alkali. It will burn the throat and mouth as severely coming up as it did going down. It may get into the lungs and burn there also.
- If the victim has swallowed an emulsifiable concentrate or oil solution. Emulsifiable concentrates and oil solutions may cause death if inhaled during vomiting.

## **Heat Stress**

Heat stress is the illness that occurs when your body is subjected to more heat than it can cope with. Heat stress is not caused by exposure to pesticides,

but may affect pesticide handlers who are working in hot conditions. Personal protective equipment worn during pesticide handling activities can increase the risk of heat stress by limiting your body's ability to cool down. If you are under a physician's care, you should consult your physician before working in hot conditions.

## **Signs and Symptoms of Heat Stress**

Mild forms of heat stress will make you feel ill and impair your ability to do a good job. You may get tired sooner, feel weak, be less alert, and be less able to use good judgment. Severe heat stress is a serious illness. Unless victims are cooled down quickly, they can die. Severe heat stress is fatal to more than 10 percent of its victims, even young, healthy adults. Many who survive suffer permanent damage. Sometimes the victims remain highly sensitive to heat for months and are unable to return to the same work.

Learn the signs and symptoms of heat stress and take immediate action to cool down if you suspect you may be suffering from even mild heat stress. Signs and symptoms may include:

- fatigue (exhaustion, muscle weakness),
- headache, nausea, and chills,
- dizziness and fainting,
- severe thirst and dry mouth,
- clammy skin or hot, dry skin,
- heavy sweating or complete lack of sweating,
- altered behavior (confusion, slurred speech, quarrelsome or irrational attitude).

## **First Aid for Heat Stress**

It is not always easy to tell the difference between heat stress illness and pesticide poisoning. The signs and symptoms are

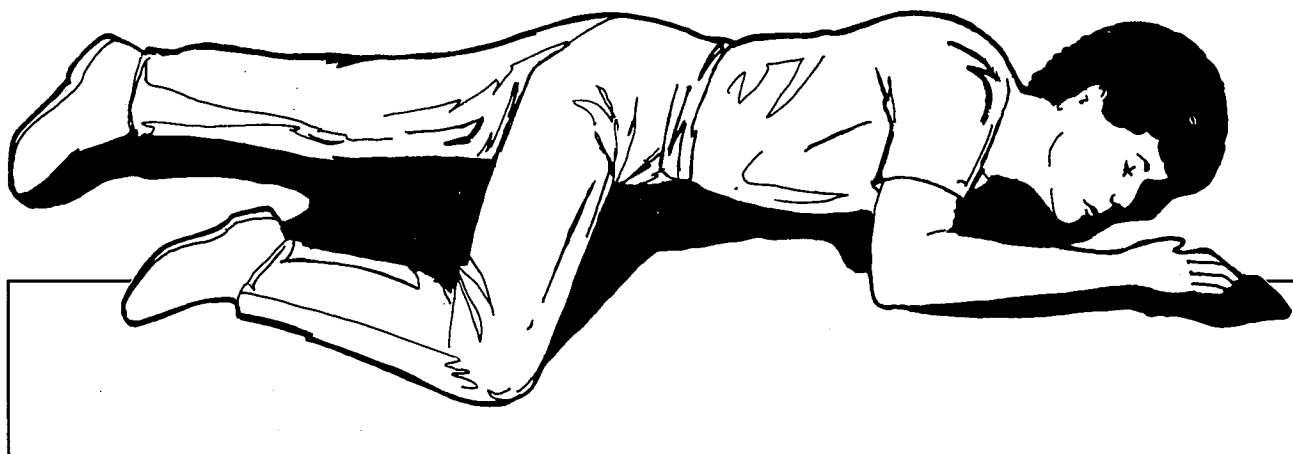

similar. Don't waste time trying to decide what is causing the illness. Get medical help.

First aid measures for heat stress victims are similar to those for persons who are overexposed to pesticides:

- Get the victim into a shaded or cool area.
- Cool victim as rapidly as possible by sponging or splashing skin, especially face, neck, hands, and forearms, with cool water or, when possible, immersing in cool water.
- Carefully remove all personal protective equipment and any

other clothing that may be making the victim too warm,

- Have the victim, if conscious, drink as much cool water as possible.
- Keep the victim quiet until help arrives.

**Severe heat stress or heat stroke is a medical emergency! Brain damage and death may result if treatment is delayed.**

## Heat Cramps

Heat cramps can be quite painful. These muscle spasms in the legs, arms, or stomach are caused by loss of body salt through heavy sweating. To relieve cramps, have the victim drink lightly salted water or "sports drinks." Stretching or kneading the muscles may temporarily relieve the cramps. However, if you suspect that stomach cramps are being caused by pesticides rather than heavy sweating, get medical help right away.

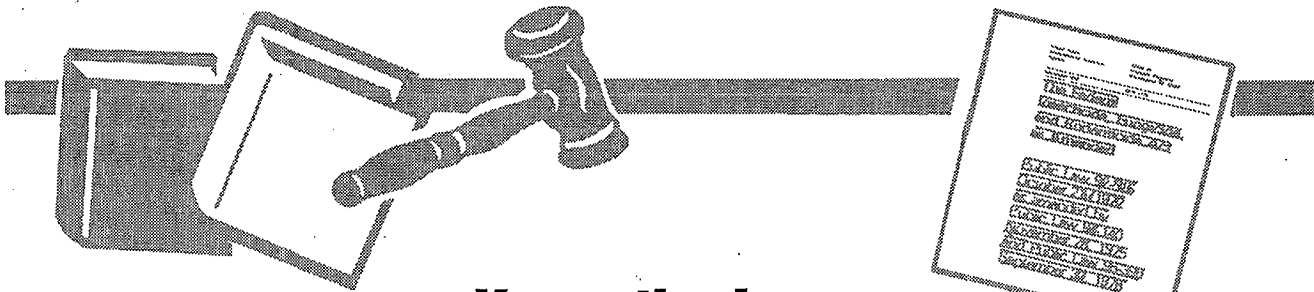

## Know the Law

The **Hazard Communication Standard (HCS)**, a regulation under the Occupational Safety and Health Act (OSHA), requires employers to provide protections to workers who may be exposed to hazardous chemicals under normal operating conditions or in foreseeable emergencies. The HCS, which is administered by the U.S. Department of Labor, requires employers to:

- make a list of the hazardous chemicals in the workplace,
- obtain material safety data sheets (MSDS) for all hazardous substances on their list,

- ensure that all containers of hazardous materials are labeled at all times,
- train all workers about the hazardous materials in their workplace, and
- keep a file (including the MSDS's) on the hazardous chemicals, and make it available to workers.

The **Occupational Safety and Health Act (OSHA)**, administered by the U.S. Department of Labor, contains some requirements that could affect you if you or one of your employees is

involved in a pesticide-related injury or illness.

- Employers must keep records of all work-related deaths, injuries, and illnesses and make periodic reports. Minor injuries needing only first aid treatment need not be reported. You must keep records if the injury involved medical treatment, loss of consciousness, restriction of work or motion, or transfer to another job.
- OSHA will investigate employee complaints related to exposure to hazardous materials, such as pesticides.

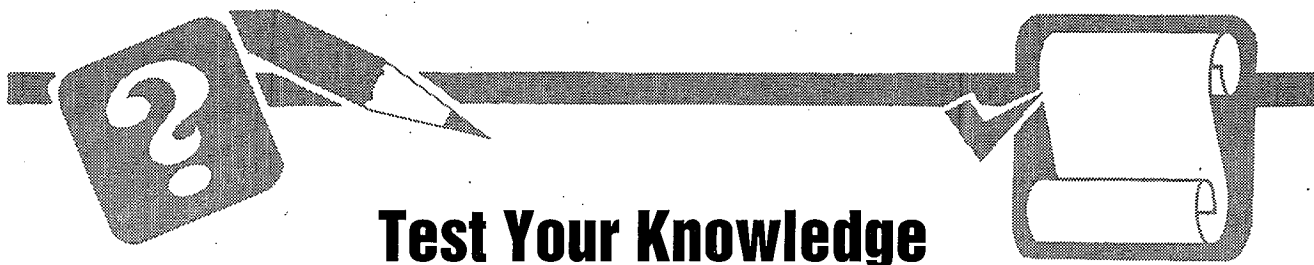

## Test Your Knowledge

**Q.** Explain the terms hazard, toxicity, and exposure, and tell how they relate to one another.

**A.** Hazard is the risk of harmful effects from pesticides. Toxicity is a measure of the ability of a pesticide to cause harmful effects. Exposure is the total amount of pesticide that gets on or in the body.  $\text{HAZARD} = \text{TOXICITY} \times \text{EXPOSURE}$ .

**Q.** What are the four routes through which pesticides can contact your body and cause you to be exposed?

**A.** 1. Oral exposure (when you swallow a pesticide),  
2. Inhalation exposure (when you inhale a pesticide),  
3. Ocular exposure (when you get a pesticide in your eyes), and  
4. Dermal exposure (when you get a pesticide on your skin).

**Q.** Which route of exposure should you, as a pesticide handler, be most concerned about?

**A.** Exposure to the skin is the most common route of exposure for pesticide handlers.

**Q.** What three factors determine how much pesticide will be absorbed through your skin and into your body?

**A.** The amount of pesticide that is absorbed through your skin (and eyes) and into your body depends on:

1. The pesticide itself and the material used to dilute the pesticide.
2. Which area of the body is exposed.
3. The condition of the skin that is exposed.

**Q.** Explain acute effects, delayed effects, and allergic effects.

**A.** Acute effects are illnesses or injuries that may appear immediately after exposure to a pesticide (usually within 24 hours). Delayed effects are illnesses or injuries that do not appear immediately (within 24 hours) after exposure to a pesticide or combination of pesticides. Allergic effects are harmful effects that some people develop in reaction to pesticides that do not cause the same reaction in most other people.

**Q.** How can you avoid harmful effects from pesticides?

**A.** Avoiding and reducing exposures to pesticides will reduce the harmful effects from pesticides. You can avoid exposures by using safety systems, such as closed systems and enclosed cabs, and you can reduce exposures by wearing appropriate personal protective equipment, washing exposed areas often, and keeping your personal protective equipment clean and in good operating condition.

**Q.** Name four signs or symptoms of pesticide poisoning and

two signs or symptoms of irritation effects from pesticides.

**A.** Pesticide poisoning may cause nausea, vomiting, diarrhea, and/or stomach cramps; headache, dizziness, weakness, and/or confusion; excessive sweating, chills, and/or thirst; chest pains; difficult breathing; cramps in your muscles or aches all over your body.

External irritants may cause redness, blisters, rash, and/or burns on skin, and swelling, a stinging sensation, and/or burns in eyes, nose, mouth, and throat.

**Q.** What is the first thing you should do when you or someone else is overexposed to pesticides?

**A.** The best first aid in pesticide emergencies is to stop the source of pesticide exposure as quickly as possible. If pesticide is on the skin or in the eyes, flood with water; if the pesticide has been swallowed, drink large amounts of water; if the pesticide has been inhaled, get to fresh air.

**Q.** What is heat stress?

**A.** Heat stress is the illness that occurs when your body is subjected to more heat than it can cope with.

**Q.** What are some common signs and symptoms of heat stress?

**A.** Heat stress may cause fatigue (exhaustion, muscle weakness); headache, nausea, and chills; dizziness and fainting; severe thirst and dry mouth; clammy skin or hot, dry skin; heavy sweating or complete lack of sweating; altered behavior (confusion, slurred speech, and quarrelsome or irrational behavior).

**Q.** If you are not sure whether a person is suffering from heat stress or pesticide poisoning, what should you do?

**A.** Because so many signs and symptoms could be from either heat stress or pesticide poisoning, do not waste time trying to diagnose the problem — get medical help. In the meantime, get the person to a cooler place that is away from pesticides. Remove personal protective equipment or other clothing that could be contaminating the skin or making the person too warm, use water to clean and cool the skin, and give the person plenty of water to drink.



# Personal Protective Equipment

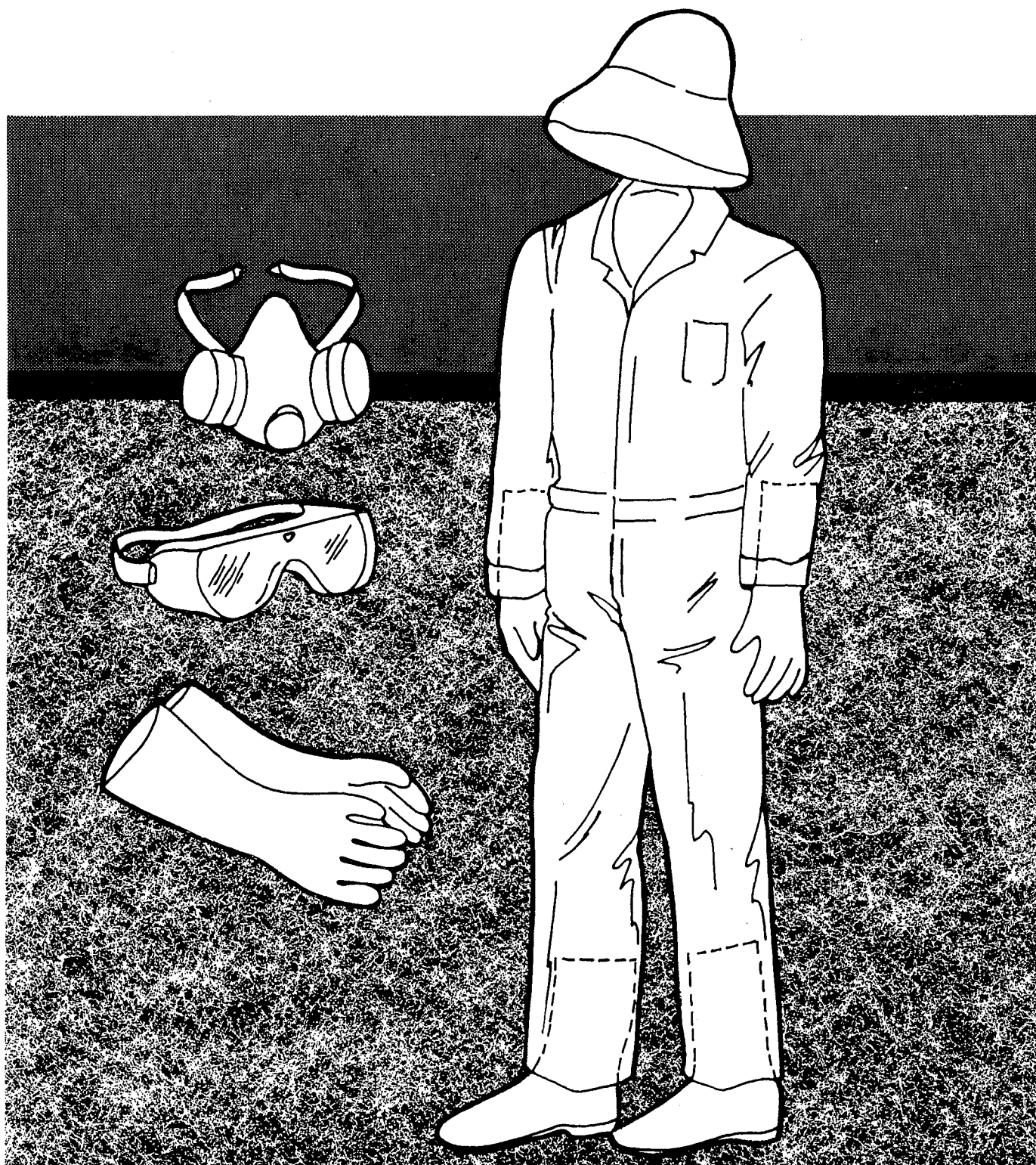

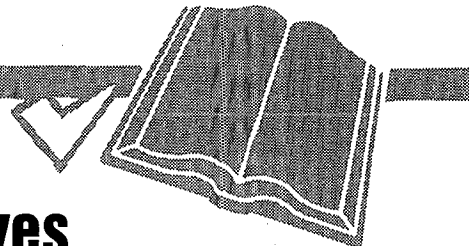
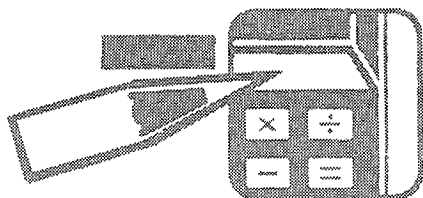

## Learning Objectives

After you complete your study of this unit, you should be able to:

- Describe your legal responsibility for following personal protective equipment requirements in pesticide labeling.
- Define the term “chemical resistant,” and explain how to tell when a material is not chemical resistant to a particular pesticide.

- Identify factors that determine how well a coverall will protect your body.
- Explain the importance of wearing gloves when you handle pesticides.
- Give reasons why gloves and footwear may fail to protect you.
- Explain when you should wear protective headgear, and describe appropriate headgear.
- Explain the term “protective eyewear.”

- Distinguish among dust/mist filtering respirators, vapor-removing respirators, and air-supplying respirators.
- Describe the special hazards that fumigants pose.
- Explain some basic guidelines for cleaning and maintaining personal protective equipment items.

## Terms To Know

**Acute effects** — Illnesses or injuries that may appear immediately after exposure to a pesticide (usually within 24 hours).

**Concentrates** — Pesticides that have a high percentage of active ingredient.

**Delayed effects** — Illnesses or injuries that do not appear immediately (within 24 hours) after exposure to a pesticide or combination of pesticides.

**Diluent** — Anything used to dilute a pesticide.

**Exposure** — Coming into contact with a pesticide, getting a pesticide on a surface or in or on an organism.

**Labeling** — The pesticide product label and other accompanying materials that contain directions that pesticide users are legally required to follow.

**MSHA** — Mine Safety and Health Administration.

**NIOSH** — National Institute for Occupational Safety and Health.

**OSHA** — Occupational Safety and Health Administration in the United States Department of Labor.

**Pesticide handler** — Person who directly handles pesticides, such as during mixing, loading, transporting, storing, disposing, and applying or working on pesticide equipment.

**Precautionary statement** — Pesticide labeling statement that alerts you to possible hazards from use of the pesticide product and that may indicate specific ways to avoid the hazards.

**Residue** — The part of a pesticide that remains in the environment for a period of time following application or a spill.

**Solvent** — A liquid, such as water, kerosene, xylene, or alcohol, that will dissolve a pesticide (or other substance) to form a solution.

**Water-based pesticides** — Pesticides that use water as the only diluent or carrier.

**P**ersonal protective equipment (PPE) is clothing and devices that are worn to protect the human body from contact with pesticides or pesticide residues. Personal protective equipment includes such items as coveralls or protective suits, footwear, gloves, aprons, respirators, eyewear, and headgear.

Ordinary shirts, pants, shoes and other regular work clothing usually are not considered personal protective equipment, although the pesticide labeling may require you to wear specific items of work clothing during some activities.

Exposure to pesticides can cause harmful effects. To prevent or reduce exposure to pesticides, you need to wear personal protective equipment. **You are legally required to follow all personal protective equipment instructions that appear on the label or in labeling.**

Remember, the lack of any requirement for personal protective equipment or the mention of only one piece of equipment does not rule out the need for more protection. No pesticide labeling instructions can cover all situations. Your common sense, the

information on the labeling about precautions for humans, and the task you will be performing will help you to assess your potential hazard and to select the amount and kind of personal protective equipment you need for each handling job.

Pesticide labeling lists the **minimum** personal protective equipment you must wear while handling the pesticide. Sometimes the labeling lists different requirements for different activities. For example, more personal protective equipment may be required for mixing and loading than for application.

## **Chemical-Resistant Personal Protective Equipment**

Some pesticide labeling requires you to wear chemical-resistant personal protective equipment. You must select a material that will be resistant for the period of time that you will be exposed to the pesticide. Most chemical-resistant personal protective equipment items are made of plastic or rubber, but these materials are not equally resistant to all pesticides and in all circumstances.

## **Factors Affecting Chemical Resistance**

How chemical-resistant a material will be in your pesticide handling situation depends on the length of exposure, the exposure situation, and the chemical to which the material is exposed.

### **Length of exposure**

Not all types of materials that are resistant to a particular pesticide will protect you for the same amount of time. Some materials will keep the pesticide out for a fairly long time. Others will allow the pesticide to go through the material to your skin fairly quickly. Thin materials, such as disposable plastic gloves, shoe covers, or aprons, may be as much protection as you need for tasks that can be done in a few minutes. Longer jobs usually require items made of a heavier material.

Chemical resistance is often stated in terms of exposure time. For example, neoprene is resistant to acetone for 30 minutes or less and to diesel fuel for more than 4 hours. If you wear neoprene gloves while handling pesticides with an acetone solvent, you must change the gloves at least every 30 minutes; otherwise, the pesticide

and the acetone will get through the gloves and onto your hands.

### Exposure situation

Even a chemical-resistant material will not continue to protect you if it becomes damaged during the pesticide handling task. For tasks that involve handling sharp or pointed objects or walking through rough terrain, for example, a heavy-duty or sturdy material probably would be necessary to ensure chemical resistance.

### Type of chemical

Very few materials will protect you from all pesticide products. The level of chemical resistance may depend not only on what the active ingredient is, but also on whether the pesticide is liquid or dry and what diluents or solvents are used.

### Choosing Chemical-Resistant Materials

Always read the pesticide labeling to see if it tells you what materials are resistant to the pesticide product. If it does not, look for another source of help in making a selection. The Environmental Protection Agency, the United States Department of Agriculture - Cooperative Extension Service, pesticide producers, or personal protective equipment manufacturers may issue guidance about which materials are resistant to particular pesticides. When no outside advice is available, you must use your own best judgment in selecting a material.

When you must select a chemical-resistant material, there are some general guidelines to follow. Cotton, leather, canvas, and other absorbent materials are not chemical resistant, even to dry formulations. Powders and dusts

sometimes move through cotton and other woven materials as quickly as wet formulations and may remain in the fibers even after three launderings. Do not use hats that have a cloth or leather sweatband, and do not use cloth or cloth-lined gloves, footwear, and aprons. These materials are difficult or impossible to clean after pesticide gets on them, and they are too expensive to be disposed of after each use.

### Chemical-resistant suits and hoods

The best choice of materials for chemical-resistant suits and hoods is generally:

- rubber or plastic, such as butyl, neoprene, or polyvinyl chloride (PVC), or
- nonwoven fabric coated with plastic or another barrier material.

Read the packaging for the suits carefully to be sure that they are "chemical resistant," "chemical protective," or "liquidproof."

### Other chemical-resistant items

For other chemical-resistant items, such as gloves, footwear, aprons, and hats, you can choose from many types of materials. Foil-laminate materials are resistant to most pesticides, but many pesticide handlers consider them uncomfortable to wear and difficult to use while performing many tasks.

**Any plastic or rubber material is resistant to dry pesticides and to water-based pesticides.** Dry pesticides include dusts, granules, pellets, and some baits. Water-based pesticides include wettable powders, soluble powders, some solutions, dry flowables (water-dispersible granules), and microencapsulated pesticides.

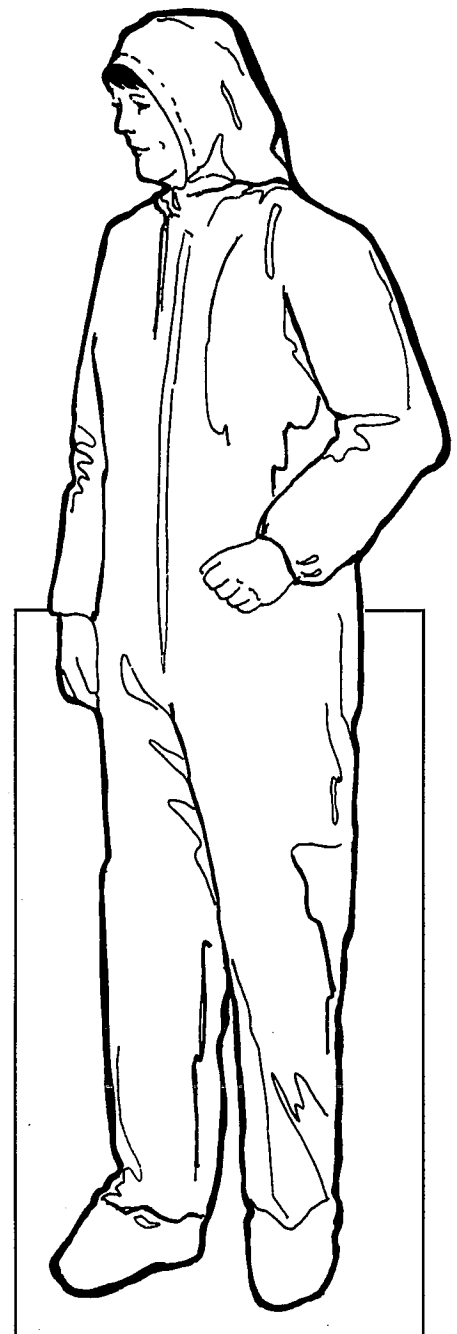

The type of material that is resistant to non-water-based liquid pesticides depends on the type of solvent used. Pesticides that do not dissolve in water are often mixed with other solvents to form liquid formulations. Liquid pesticides that are not water based include emulsifiable concentrates, ultra-low-volume and low-volume concentrates, low-concentrate solutions, flowables, aerosols, and invert emulsions.

Common solvents are xylene, fuel oil, other petroleum distillates, and alcohol. When xylene is in a formulation, it must be listed in the ingredient statement on the front panel of the pesticide label.

Some solvents do not have to be listed in the ingredient statement, so you may not be able to choose a chemical-resistant material on the basis of what is in the formulation. For these pesticides, select sturdy foil-laminate, butyl, or nitrile materials. Then watch for signs that the material is not chemical resistant. Sometimes it is easy to see when a plastic or rubber is not resistant to a pesticide. The material may:

- change color,
- become soft or spongy,
- swell or bubble up,
- dissolve or become like jelly,
- crack or get holes,
- become stiff or brittle.

If any of these changes occur, discard the items and choose another type of material.

## Protecting Your Skin

The skin is the part of your body that usually gets the most exposure while you are handling pesticides. Pay particular attention to covering as much of your skin as possible. Remember that personal protective equipment protects you only if the pesticide remains on the outside of the material. Once the pesticide gets on the inside and next to your skin, the material works against you. It holds the pesticide tightly next to your skin for as long as it is worn. When this happens, more pesticide will get on your skin and cause irritation or will go through your skin and into your body.

## Body Protection

Any time you handle pesticides, wear at least a long-sleeved shirt and long-legged pants. In many instances the pesticide labeling will require you to wear a coverall, a chemical-resistant suit, or a chemical-resistant apron.

### Long-sleeved shirt and long-legged pants

Long-sleeved shirt and long-legged pants should be made of sturdy material. Fasten the shirt collar completely to protect the lower part of your neck.

### Coveralls

Coveralls should be made of sturdy material such as cotton, polyester, a cotton-synthetic blend, denim, or a nonwoven fabric. One-piece coveralls look like jump suits or flight suits. Two-piece coveralls look like surgeons' suits. When wearing a coverall, close the opening securely so the entire body except the feet, hands, neck, and head are covered. If you wear a two-piece coverall, do not tuck it in at the waist; the shirt should extend well below the waist of the pants and fit loosely around the hips.

When handling pesticides that are highly or moderately toxic dermally or are skin irritants, always wear a coverall over another set of clothing that covers your body at least from shoulders to thighs. An entire set of clothing such as a long-sleeved shirt and long-legged pants worn under the coverall is ideal. Sometimes the pesticide labeling will specify a particular type of clothing to be worn under the coverall.

Several factors determine how well a coverall will protect you. Each layer of clothing and each layer of air between the pesticide and your skin provides added



protection. That is why the coverall should fit loosely. If it fits tightly, there will not be a layer of air between it and your skin, and any pesticide getting through the coverall will be in direct contact with your skin.

The design and structure of coveralls also affect how well they will protect you. Well-designed coveralls have tightly constructed seams and snug, overlapping

closures that do not gap or become unfastened readily. This construction makes it harder for pesticides to get through these areas and onto your inner clothing or your skin.

### Chemical-resistant suit

Some pesticide labeling requires handlers to wear a chemical-resistant suit. This usually indicates that the pesticide is very hazardous, either for acute effects or for delayed effects, and that extra precaution is necessary to prevent the pesticide from getting on you.

If you expect to be in a situation where a large amount of pesticide could be deposited on your clothing, and if you will be in that situation for a long time,

consider wearing a chemical-resistant suit even if the pesticide labeling does not require you to do so. Under those circumstances, even pesticides that are applied dry, such as dusts or granules, can get through ordinary fabric and harm you.

Chemical-resistant suits made of rubber or plastic often are referred to as "rainsuits." They may be sold as one-piece coveralls or as two-piece outfits consisting of a jacket worn over overalls. Chemical-resistant suits made of coated nonwoven fabric usually are sold as one-piece coveralls.

The biggest drawback to chemical-resistant suits is that they may make you uncomfortably warm. Unless you are handling

pesticides in cool or climate-controlled environments, heat stress becomes a major concern. Wearing a chemical-resistant suit in even moderate temperature and humidity conditions can cause you to become overheated very quickly. Take extra precautions to avoid heat stress by drinking plenty of water and taking frequent rest breaks to cool down.

### Chemical-resistant apron

The pesticide labeling may require you to wear a chemical-resistant apron while you are mixing and loading the pesticide and while you are cleaning pesticide equipment. Consider wearing an apron whenever you are handling pesticide concen-

## Interpreting Labeling PPE Statements

### Labeling Statement

Long-sleeved shirt and long-legged pants

### Acceptable PPE

Long-sleeved shirt and long-legged pants, or  
Woven or nonwoven coverall, or  
Plastic- or other barrier-coated coverall, or  
Rubber or plastic suit

Coverall worn over short-sleeved shirt and short pants

Coverall worn over short-sleeved shirt and short pants, or  
Coverall worn over long-sleeved shirt and long-legged pants, or  
Coverall worn over another coverall, or  
Plastic- or other barrier-coated coverall, or  
Rubber or plastic suit

Coverall worn over long-sleeved shirt and long-legged pants

Coverall worn over long-sleeved shirt and long-legged pants, or  
Coverall worn over another coverall, or  
Plastic- or other barrier-coated coverall, or  
Rubber or plastic suit

Chemical-resistant apron worn over coverall or over long-sleeved shirt and long-legged pants

Chemical-resistant apron worn over coverall or long-sleeved shirt and long-legged pants, or  
Plastic- or other barrier-coated coverall, or  
Rubber or plastic suit

Chemical-resistant protective suit

Plastic- or other barrier-coated coveralls, or  
Rubber or plastic suit

Waterproof suit or liquidproof suit

Plastic- or other barrier-coated coveralls, or  
Rubber or plastic suit





trates. It will protect you from splashes, spills, and billowing dusts and will protect your coverall or other clothing. Wear an apron over the coverall or long-sleeved shirt and long-legged pants required for application or other handling activities.

Choose an apron that extends from your neck to at least your knees. Some aprons have attached sleeves and gloves. This style is especially protective because it

protects your arms, hands, and front and eliminates the potential gap where the sleeve and glove or sleeve and apron meet.

An apron can sometimes be a safety hazard. It can get caught in some machinery or get in your way in some situations. At those times, you may choose to wear a chemical-resistant suit instead.

### **Hand and Foot Protection**

Pesticide handlers get by far the most pesticide exposure on their hands and forearms. As a result, most pesticide labeling will require you to wear chemical-resistant gloves at all times while handling the pesticide. Wear chemical-resistant gloves any time you may get pesticides on your hands.

Pesticide handlers also often get pesticides on their feet. Sturdy shoes and socks are sufficient to protect your feet during a few pesticide handling activities. Canvas, cloth, and leather are difficult or impossible to clean adequately, however. Consider using chemical-resistant materials when pesticides or pesticide residues, especially concentrates, may get on your footwear.

Some pesticide labeling requires you to wear chemical-resistant footwear. Such footwear can be shoes, shoe covers, or boots. If a pesticide is likely to get on your lower legs or feet, consider wearing chemical-resistant boots. The boots should extend past your ankle and at least halfway up to your knee.

One situation where you should not wear chemical-resistant gloves and footwear is during the handling of a few fumigants, such as methyl bromide, because the gloves and footwear can trap the gas near the skin and cause burns. The labeling on these fumigants

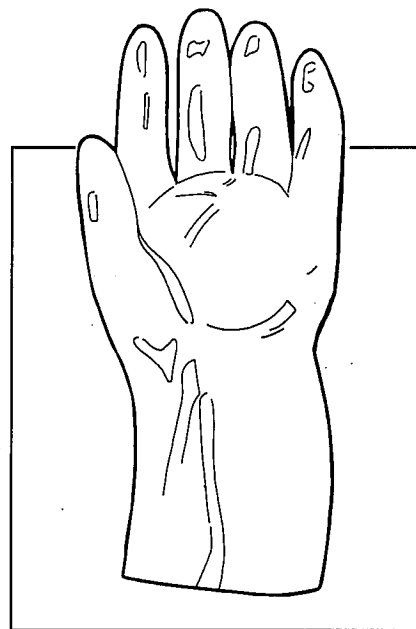

will instruct you not to wear chemical-resistant gloves and footwear or other chemical-resistant clothing.

### **Wear gloves and footwear correctly**

Always start out with gloves and footwear that you know are new or freshly cleaned. Don't choose a pair just because they are close by. They may already have pesticides on the inside and will not protect your hands or feet.

If pesticides get inside your gloves or footwear, you must take them off right away, wash your hands or feet, and put on a clean pair. Keep several pairs of gloves and footwear available and change to a clean set whenever you suspect the inside has become contaminated.

### **Avoid contaminating the inside of gloves and footwear**

Even when you are wearing gloves and footwear, you can get pesticides on your hands and feet unless the gloves and footwear are:

- chemical-resistant to the pesticide being handled,

# Interpreting Labeling PPE Statements

## Labeling Statement

Waterproof gloves

## Acceptable PPE

Any rubber or plastic gloves sturdy enough to remain intact throughout the task being performed

Chemical-resistant gloves

Barrier-laminate gloves, or  
Other gloves that glove selection charts or guidance documents indicate are chemical-resistant to the pesticide for the period of time required to perform the task

Chemical-resistant gloves such as butyl or nitrile

Butyl gloves, or  
Nitrile gloves, or  
Other gloves that glove selection charts or guidance documents indicate are chemical-resistant to the pesticide for the period of time required to perform the task

Shoes

Leather, canvas or fabric shoes, or  
Chemical-resistant shoes, or  
Chemical-resistant boots, or  
Chemical-resistant shoe coverings (booties)

Chemical-resistant footwear

Chemical-resistant shoes, or  
Chemical-resistant boots, or  
Chemical-resistant shoe coverings (booties)

Chemical-resistant boots

Chemical-resistant boots

- worn correctly,
- in good condition,
- cleaned and cared for, and
- replaced often.

Contamination often happens when handlers remove their gloves briefly to adjust their equipment, open a pesticide container, wipe their face, etc., and then put the gloves on again over their contaminated hands. If you must remove your gloves during a handling activity, **wash your gloves thoroughly before taking them off, and wash your hands thoroughly and dry them before you put the gloves on again.**

Handlers also sometimes make the mistake of putting on footwear with contaminated hands. This

may transfer the pesticide from your hands to your socks and feet.

You must keep pesticides from running down your sleeves or pants legs and into your gloves and footwear. For many jobs, you

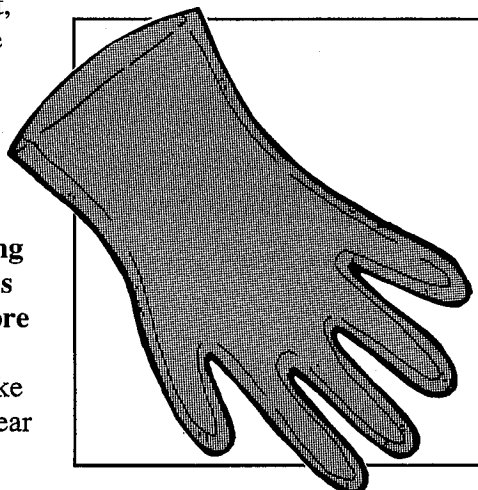

will be working some of the time with your arms raised and some of the time with them lowered. Close the glove cuff tightly outside the sleeve and put heavy-duty tape or an elastic band around the end of the glove where it meets the sleeve. Some gloves have a method of tightening the cuff to your sleeve so the pesticide cannot run down into the glove.

Place sleeves outside the gloves to keep pesticides from running down the sleeves and into the gloves. Use gloves that go up over your wrist and at least half way to your elbow.

For jobs when you will be exposed to pesticides on your legs, put your pants legs outside the



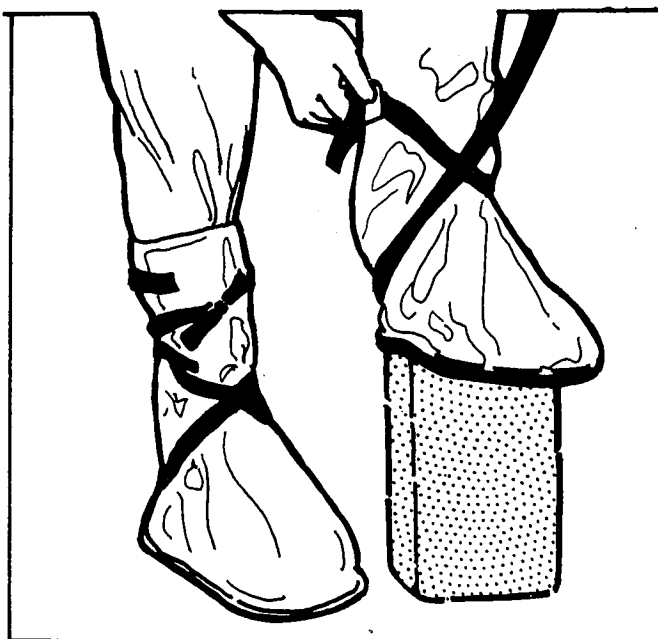

boots so the pesticide will not travel down your leg and collect in the boots or shoe covers.

### Head and Neck Protection

If you will be exposed to pesticides from above, wear something to protect your head and neck. A chemical-resistant

hood or wide-brimmed hat will help keep pesticides off your head, neck, eyes, mouth, and face. Plastic "safari" hats with plastic sweatbands are a good choice. They are relatively cool in hot weather. Other more flexible hats and hoods are also available in chemical-resistant materials. Many chemical-resistant jackets or

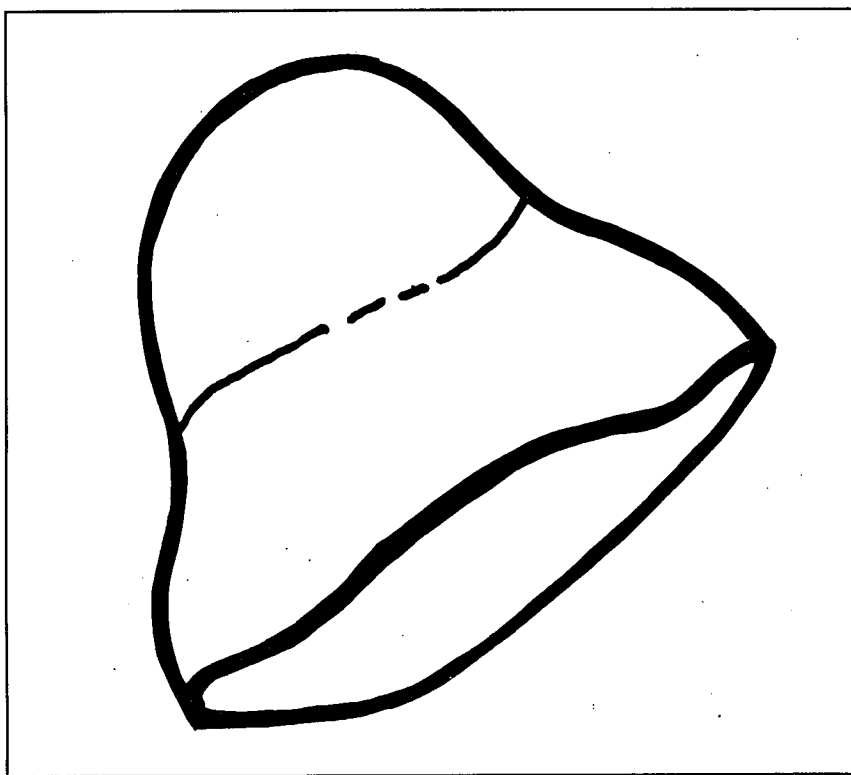

coveralls can be purchased with attached protective hoods.

### Protecting Your Eyes

When the pesticide labeling requires you to wear protective eyewear, wear goggles, a face shield, or safety glasses with shields at both the brow and sides. Eyes are very sensitive to the chemicals in some pesticide formulations, especially concentrates, and temporary blindness caused by an accident may delay or prevent self-treatment. Eyes also readily absorb some pesticides.

Shielded safety glasses or full-face shields are a good choice in many handling situations, because they are comfortable, do not cause fogging or sweating, and give good eye protection for many exposure situations. Face shields that are cupped inward towards your throat give better protection from splashes than straight face shields. However, if you will be in an open cab during an airblast application, flagging directly under an aerial application, applying mists, fogs, or aerosols indoors, or in any other situation where you will be enveloped in a spray, mist, or dust, wear goggles that fit tightly against your face.

Either goggles or shielded safety glasses can be worn with a half-face respirator. Full-face respirators are supplied with their own face shield, so additional eye protection is not required.

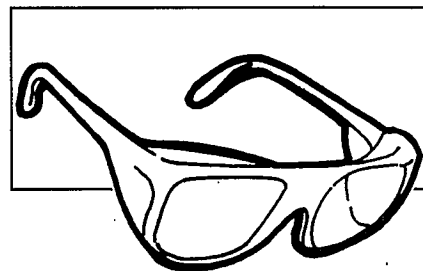

# Interpreting Labeling PPE Statements

## Labeling Statement

Chemical-resistant hood or wide-brimmed hat

## Acceptable PPE

Rubber- or plastic-coated safari-style hat, or  
Rubber- or plastic-coated firefighter-style hat, or  
Plastic- or other barrier-coated hood, or  
Rubber or plastic hood, or  
Full hood or helmet that is part of some  
respirators

Protective Eyewear

Shielded safety glasses, or  
Face shield, or  
Goggles, or  
Full-face style respirator

Goggles

Goggles, or  
Full-face style respirator

Dust/mist filtering respirator

Dust/mist respirator, or  
Respirator with dust/mist filtering cartridge, or  
Respirator with organic vapor-removing cartridge  
and pesticide prefilter, or  
Respirator with canister approved for pesticides,  
or Air-supplying respirator

Cartridge respirator

Respirator with organic vapor-removing cartridge  
and pesticide prefilter, or  
Respirator with canister approved for pesticides,  
or Air-supplying respirator

Canister respirator (gas mask)

Respirator with canister approved for pesticides,  
or Air-supplying respirator

Air-supplying respirator or  
Self-contained breathing apparatus (SCBA)

Air-supplying respirator, or  
Self-contained breathing apparatus (SCBA)

## Protecting Your Respiratory Tract

The respiratory tract — the lungs and other parts of the breathing system — is much more absorbent than the skin. You must wear a respirator when the pesticide labeling directs you to do so. Even if the labeling does not require it, you should consider wearing a respiratory protective device:

- if you are in an enclosed area and the pesticide you are handling

has a labeling precautionary statement such as “do not breathe vapors or spray mist,” or “harmful or fatal if inhaled,” or

- if you will be exposed for a long time to pesticides that are in or near your breathing zone.

Some fumigants and a few other pesticide formulations contain an additive that will warn you if you begin to inhale the pesticide. Such warning agents often are used when the active ingredients in the pesticide are highly toxic ones that you would

otherwise not be able to detect. The additive may have a characteristic odor or be a mild irritant to alert you that you should put on a respirator or that your respirator is no longer protecting you. The warning agent can help you determine when you should use a respirator for products whose labeling does not require respiratory protection in all situations.

Some pesticide labeling lists the type of respirator you should wear when handling the product. Other labeling requires the use of

a respirator, but does not specify the type or model to be used. NIOSH and MSHA approve respirators as adequate for certain types of uses. When the pesticide labeling requires you to use a respirator, you must wear one that is approved by NIOSH and MSHA. If the respirator has more than one part, all the parts must be approved.

Studies have shown that many pesticide handlers do not use respirators correctly and so are not being well protected. Before you use a respirator, you should be trained in the correct procedures for selecting, fitting, cleaning and sanitizing, inspecting, and maintaining respiratory protective equipment.

There are two basic types of respirators:

- **air-supplying respirators**, which supply you with clean, uncontaminated air from an independent source, and
- **air-purifying respirators**, which remove contaminants from the air around you.

### **Air-Supplying Respirators**

Air-supplying respirators are used in a few specialized situations where other types of respirators are not protective enough. Use an air-supplying respirator when the pesticide labeling tells you to. In addition, you should use one when handling pesticides:

- when the oxygen supply is low, or
- during fumigation in enclosed areas, such as greenhouses or other buildings, railcars, ship holds, or grain bins.

### **Supplied-air respirators**

These respirators pump clean air through a hose to the face mask. You are limited to working within the distance the hose can reach from the supply of clean air.

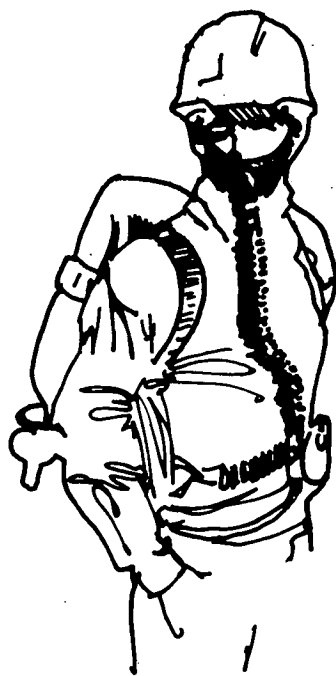

### **Self-contained breathing apparatus**

This type of respirator supplies clean air from cylinders that you carry with you, usually on your back. This lets you move more freely and over a wider area than you can with a supplied-air respirator. Get training from competent instructors before using self-contained breathing equipment. These devices contain a limited air supply (usually about 30 to 45 minutes), which may be used up even more quickly in high temperatures or with excessive exertion.

### **Air-Purifying Respirators**

In most situations where pesticide handlers need to use a respirator, some type of air-purifying respirator provides enough protection. Air-purifying respirators will not protect you from fumigants, from extremely

high concentrations of vapor, or when the oxygen supply is low.

### **Functions of air-purifying respirators**

Air-purifying respirators remove contaminants from the air in two ways:

- by filtering dusts, mists, and particles, and
- by removing gases and vapors.

Sometimes you will need only a respirator that filters dusts and mists from the air; at other times, you will need one that removes gases and vapors as well.

Wear a dust/mist-filtering respirator if the pesticide labeling tells you to or if you will be exposed to pesticide dusts, powders, mists, or sprays in your breathing zone. Wear a respirator that also removes vapors if the pesticide labeling tells you to or if you will be exposed to gases or vapors in your breathing zone.

### **Styles of air-purifying respirators**

Air-purifying respirators are of three basic styles:

- dust/mist masks, which usually are shaped filters that cover the nose and mouth to filter out dusts, mists, and particles,
- devices consisting of a body and one or more cartridges that contain air-purifying materials, and
- devices consisting of a body and a canister that contains air-purifying materials.

**Cartridges** may contain either dust/mist-filtering material or vapor-removing material. For pesticide handling tasks where vapor removal is needed, a prefilter must be used with the vapor-removing cartridge. The prefilter removes dusts, mists, and other particles before the air passes through the vapor-remov-

ing cartridge. A few vapor-removing cartridges have an attached prefilter, but most are sold separately. Separate prefilters are preferred for use with pesticides, because they often need to be replaced before the vapor-removing cartridge is used up.

Some cartridge-type respirators are one-piece units with cartridges permanently attached to the facepiece. After use, the entire unit is discarded. Other cartridge respirators are two-piece units with removable cartridges and a body that can be cleaned and reused. The dust/mist filtering or vapor-removing cartridges and the prefilters can be replaced when they lose their effectiveness.

A **canister** contains both dust/mist-filtering and vapor-removing material. Canisters contain more air-purifying material than cartridges. They last much longer and may protect you better in situations where the concentration of gas or vapor in the air is high. They are also much heavier and more uncomfortable to wear.

Canister-type respirators are often called gas masks. They usually have the canister connected directly to the facepiece or worn on a belt and connected to the facepiece by a flexible hose. The body is designed to be cleaned and reused. The canisters can be replaced when necessary.

### **Selecting and using dust/mist-filtering devices**

Dust/mist filtering masks and cartridges are approved by NIOSH and MSHA. You must wear one that has their stamp of approval. Nonapproved filters are not as protective and are not acceptable.

**Pesticide handlers must wear dust/mist-filtering masks or**



**Quarter-face (Cup-style) Respirator**

**cartridges with NIOSH/MSHA approval number prefix TC-21C.**

Look for a dust/mist mask that is held in place by two straps. One-strap styles are not approved by NIOSH and MSHA, because they do not keep the respirator adequately sealed against the face.

When you wear a dust/mist filter — either a mask, cartridge, or prefilter — you will have more trouble breathing as more dusts, mists, and other particles become trapped in the filter material. When breathing becomes too difficult, replace the filter. Eight hours of use is usually the limit for these filters. During continual use, you may need to change filters twice a day, or even more often in dusty or dirty conditions. Do not use a dust/mist mask when the pesticide will completely soak the mask and be held close to the skin and breathing passages. Replace

the mask if it gets soaked or loses its shape.

### **Selecting and using vapor-removing devices**

Vapor-removing devices are rated by NIOSH for the types of gases and vapors they will remove. For pesticide handling tasks where vapor protection is needed, NIOSH requires that an organic-vapor-removing material and a pesticide prefilter be used.

**Pesticide handlers must use either:**

- a cartridge approved for organic vapor removal plus a prefilter approved for pesticides (NIOSH/MSHA approval number prefix for both is TC 23C), or
- a canister approved for pesticides (NIOSH/MSHA approval number prefix is 14G).

When you wear a vapor-removing respirator, remember

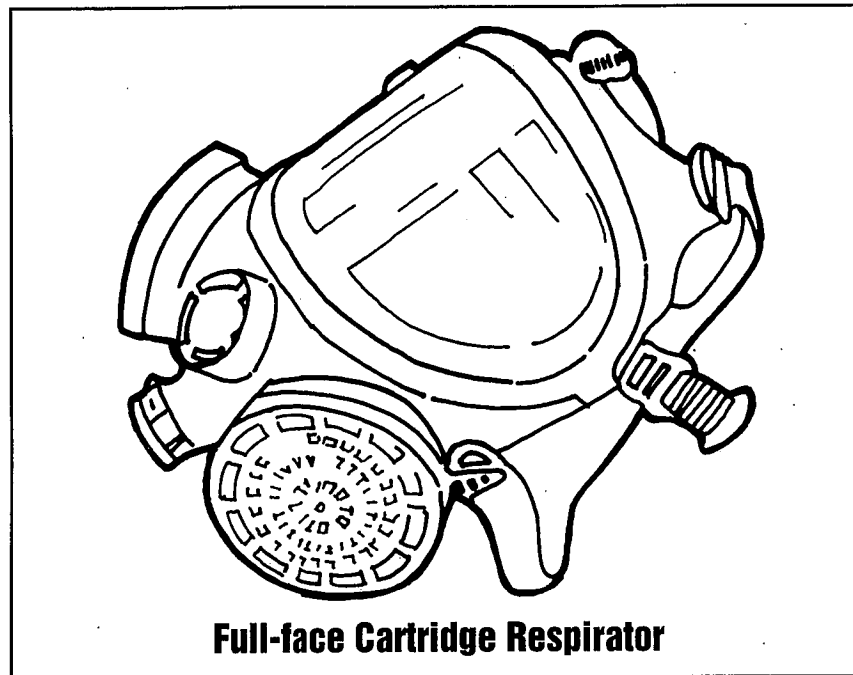

**Full-face Cartridge Respirator**

that vapor-removing materials gradually lose their ability to hold more gases and vapors. Their useful life can vary greatly depending on:

- the amount of particles in the air,
- the concentration of vapor being filtered,
- the amount of absorbent material they contain,
- the breathing rate of the wearer,
- the temperature and humidity, and
- the length of time they have been stored before use and between uses.

If you notice an odor, taste, irritation, or dizziness, that is a signal that you are no longer being protected. Some vapor-removing materials have a "service life indicator" to tell you when the material is nearly used up. The instructions on some other materials will tell you to replace them after a specific number of hours of use. If there are no instructions about replacement, change the cartridge or canister after about 8 hours of use.

### **Air-delivery systems**

Air-purifying respirators draw air through the filters and vapor-removing materials in one of two ways. Ordinary air-purifying respirators depend on the wearer's lung power to draw air through the purifying material with each breath. Powered air-purifying respirators (PAPR's) assist the wearer by pulling the air through mechanically. Dust/mist masks and most cartridge and canister respirators are nonpowered air-purifying respirators.

If you have a respiratory problem, even a temporary problem such as a cold or allergy, you cannot wear nonpowered cartridge and canister respirators. You need strong lung pressure to draw the air through the purifiers into your lungs. Even persons with normal lung capacity cannot wear these respirators for long periods of time, because they tend to be hot, uncomfortable, and exhausting.

Before you use these respirators, have a medical examination to make sure that you do not have

a medical condition that would prevent you from using such devices. If you have trouble breathing while you are wearing your respirator even though you have used and cared for it correctly, see your physician to find out whether you have a health problem.

Powered air-purifying respirators use a blower to draw air to the user. PAPR's should not be confused with air-supplying respirators, because they do not supply clean air. The air is cleaned by cartridges or canisters, as it is with other air-purifying respirators. These respirators are available as lightweight backpacks, or they may be mounted on or in application equipment where the power is supplied by the vehicle's electrical systems.

### **Fitting air-purifying respirators**

Respirators fit wearers in one of two ways. Most must seal tightly to the face; others are loose-fitting.

**Face-sealing respirators** must form a tight seal against your face to be effective. Otherwise, pesticides can leak in around the edges. People with beards cannot wear this style of respirator because a tight seal cannot be formed through the hair. These respirators must be fitted to each wearer and are not interchangeable among handlers.

Dust/mist masks are face-sealing respirators. They fit over your nose and mouth and have a clip that you press around the bridge of your nose to help form a seal. Most cartridge and canister respirators are also face-sealing respirators. **Full-face styles form and keep a tight seal better than half-face styles.**

Many pesticide handlers are not being adequately protected while

wearing face-sealing cartridge and canister respirators, because they often break the seal by pulling the respirator away from their face to get temporary relief from the heat, sweat, itching, or difficult breathing. Once the seal is broken in the exposure area, the respirator's ability to protect you is greatly reduced. Face-sealing cartridge and canister respirators are most useful for short-term tasks.

Your face-sealing respirator should be tested before you wear it in a situation where you may inhale pesticides. There are two types of tests: **fit tests** and **fit checks**. They ensure that the respirator is operating correctly and that you are being protected.

Have a **fit test** before you use your cartridge or canister respirator the first time, and then be retested periodically. Get the fit test through a program approved by NIOSH and OSHA, the agencies that regulate respirator fit testing. Public health departments, fire departments, and the Cooperative Extension Service may be able to tell you where to find an approved fit testing program.

The two main types of fit tests are:

- testing whether the wearer can detect a test substance by irritation, odor, or taste, and
- measuring the actual amount of a test substance that gets inside the facepiece.

A **fit check** is an on-the-spot check that you should do to make sure the respirator is still working correctly. Do a fit check each time you wear a face-sealing respirator.

There are two methods for checking the seal of the facepiece against your face. To check by the first method:

- close off the inlet of the canister or cartridge (cover it with your palm, replace the caps, or squeeze

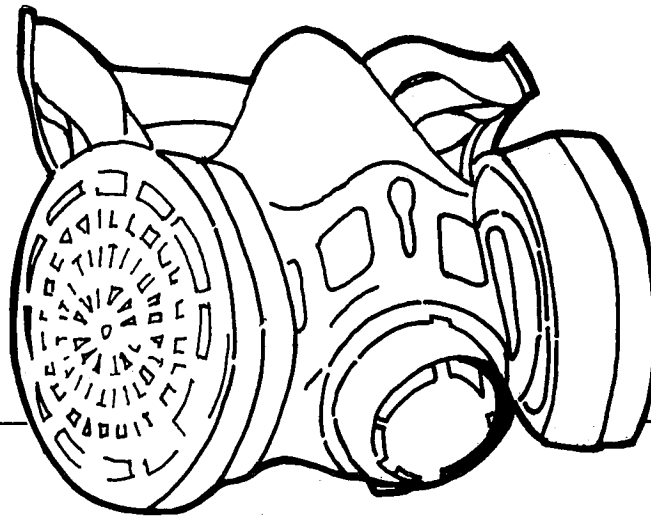

**Half-face Cartridge Respirator**

the breathing tube so that it does not allow air through),

- inhale gently so that the facepiece collapses slightly, and
- hold your breath for about 10 seconds.

If the facepiece remains slightly collapsed and no inward leakage is detected, the respirator probably fits tightly enough and will work correctly. This method does not work for dust/mist masks.

The second method for testing the facepiece seal is to close the exhalation valve with your palm and exhale gently into the facepiece. If slight pressure builds up inside the facepiece without any evidence of outward leakage, the respirator probably fits tightly enough and will work correctly. This method is not appropriate for respirators with an exhalation

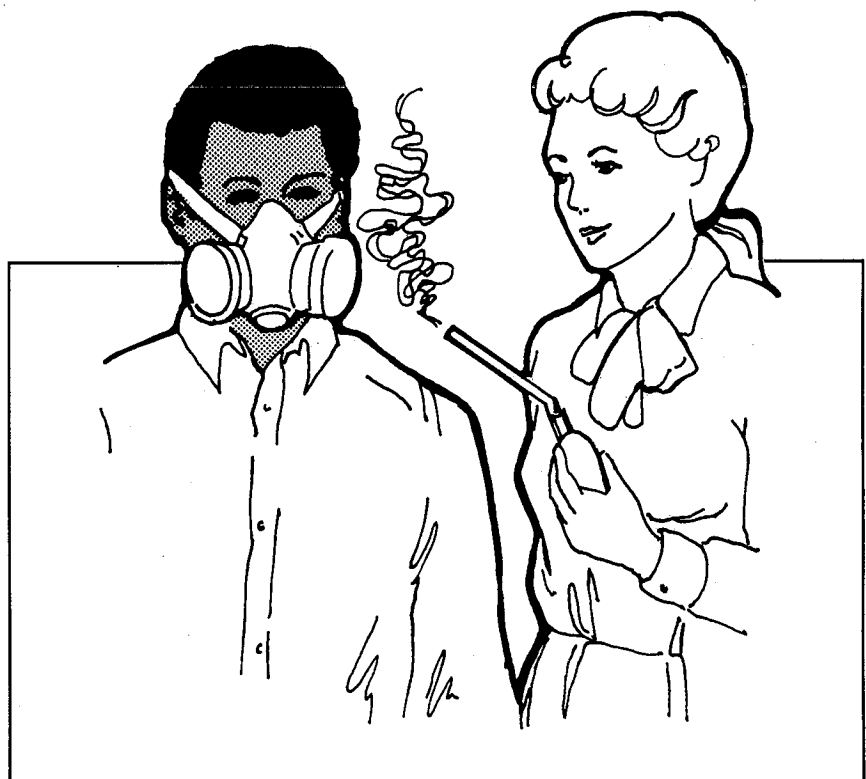



valve cover that would have to be removed first.

Another on-the-spot fit check is the use of a test substance to determine whether you can detect an odor, taste, or irritant. This fit check tests both the facepiece seal and whether a vapor-removing cartridge or canister is still working. Most test agents are gases or vapors and will not test a dust/mist-filtering mask or cartridge. Test agents are available from catalogs and dealers that sell a variety of respirators. If you cannot detect the test agent while you are wearing the respirator, it probably is working correctly.

**Loose-fitting respirators** are powered air-purifying respirators that constantly pump air through a cartridge or canister into a loose-fitting helmetlike or hoodlike head covering. The positive outward pressure caused by the steady outflow of air prevents contaminants from entering the headpiece. The purified air circulates over the user's head, face, and neck and provides some cooling.

Not all loose-fitting respirators move the air at the same rate. Most pesticide handling tasks require a minimum airflow rate of 4 cubic feet per minute. If you are doing physically strenuous work, use a respirator with an airflow rate of at least 6 cubic feet per minute.

Loose-fitting respirators do not have to form a seal on your face, so people with facial hair can use them safely. They do not require extra lung power and are not nearly as tiring or as hot as face-sealing respirators.

Loose-fitting respirators are much more expensive than face-sealing respirators. In some situations, however, they are the only safe option. For example, you might have to use one if you have facial hair that prevents an ad-

equate seal with the respirator facepiece.

In many situations, loose-fitting respirators are a good choice. For example, you might choose to use one:

- to avoid the need for fit tests and fit checks,
- if you will be exposed to pesticides for several hours at a time, or
- if you are working in situations where heat stress is a concern.

## Personal Protective Equipment for Handling Fumigants

Fumigants are pesticides that are applied as a gas or that readily form a gas when they are applied. Their pesticidal action is in the gaseous form. Fumigants are very highly toxic to plants and animals, including humans. Use extreme caution and wear appropriate personal protective equipment whenever you handle fumigants. Personal protective equipment requirements for protection from fumigants are often very different from the requirements for other types of pesticides. Follow labeling directions for each fumigant exactly.

Inhaling even small amounts of some fumigant gases can be fatal or cause severe injury. You must wear the respirator listed on the fumigant labeling. Wear it during any handling activity, including removing tarps or other coverings, when exposure to the gas is likely.

Never work alone with fumigants, especially in enclosed areas. Arrange to be monitored at all times by another handler who has immediate access to an appropriate respirator, in case rescue is needed.

While handling a fumigant indoors or in any enclosed area,

use an air-supplying respirator. In enclosed areas such as greenhouses, ship holds, railcars, bins, vaults, and chambers there may not be enough oxygen for you to breathe. Cartridge and canister respirators will not protect you in these situations.

Some fumigants readily penetrate plastic, rubber, and leather. These fumigants may be trapped **inside** gloves, boots, or tight-fitting coveralls and cause severe skin irritation or lead to poisoning through skin absorption. The labeling on these fumigants will tell you the appropriate personal protective equipment to wear while handling them. Such labeling often will tell you to wear loose-fitting clothes and “breathable” footwear such as canvas or other fabric. The labeling may tell you not to wear any gloves or to wear cotton or other absorbent gloves.

## Disposables and Reusables

Personal protective equipment items either should be disposable or should be easy to clean and sturdy enough for repeated use.

### Disposables

Disposable personal protective equipment items are not designed to be cleaned and reused. Discard them when they become contaminated with pesticides.

**Chemical-resistant gloves, footwear, and aprons** that are labeled as disposable are designed to be worn only once and then thrown away. These items often are made of thin vinyl, latex, or polyethylene. These inexpensive disposables may be a good choice for brief pesticide handling activities that require flexibility and will not tear the thin plastic.

For example, you might use disposable gloves, shoe covers, and apron while pouring pesticides into a hopper or tank, cleaning or adjusting a nozzle, or making minor equipment adjustments.

**Nonwoven (including coated nonwoven) coveralls and hoods** usually are designed to be disposed of after use. Most are intended to be worn for only one workday’s exposure period. The instructions with some coated nonwoven suits and hoods may permit you to wear them more than once if each period of use is short and they do not get much pesticide on them. Be especially alert when reusing these items, and be ready to change them whenever there are signs that pesticides could be getting through the material or that the inside surface is contaminated.

**Dust/mist masks, prefilters, canisters, filtering and vapor-removing cartridges, and a few cartridge respirators** are disposables. They cannot be cleaned, and they should be replaced often.

### Reusables

Some personal protective equipment that you buy may be designed to be cleaned and reused several times. However, do not make the mistake of reusing these items when they are no longer protecting you.

**Rubber and plastic suits, gloves, boots, aprons, capes, and headgear** often are designed to be cleaned and reused, but even these reusables should be replaced often. Wash them thoroughly between uses. Before you put them on, inspect reused items carefully for signs of wear or abrasion. If they show **any** sign of wear, throw them out. Even tiny holes or thin places can allow large quantities of pesticides to



move to the inside surface and transfer onto your skin. Check for rips and leaks during cleaning by using the rinse water to form a "balloon" or by holding the items up to the light.

Even if you can see no signs of wear, replace reusable chemical-resistant items regularly. The ability of a chemical-resistant material to resist the pesticide decreases each time the items are worn, and after repeated exposure to pesticides. Even though you do not see any changes in the material, the pesticide may be moving through the material and getting on your skin. The pesticide moves through the material in the same way air leaks through the surface of a balloon — slowly, but steadily.

A good rule of thumb is to throw out gloves that have been worn for about 5 to 7 days of work. Extra-heavy-duty gloves, such as those made of butyl or nitrile rubber, may last as long as 10 to 14 days. Because hand protection is the most important concern for pesticide handlers, make glove replacement a high priority. The cost of frequently replacing your gloves is a prudent investment. Footwear, aprons, headgear, and protective suits may last longer than gloves, because they generally receive less exposure to the pesticides and less abrasion from rough surfaces. However, they should be replaced regularly and at any sign of wear.

**Fabric coveralls** are designed to be cleaned after each day's use and reused. However, absorbent materials such as cotton, polyester, cotton blends, denim, and canvas cannot be cleaned adequately after they are drenched or thoroughly contaminated with concentrated pesticides labeled with the signal word "DANGER" or "WARNING". Always discard any such

clothing or footwear. They cannot be safely reused.

**Most protective eyewear and respirator bodies, facepieces and helmets** are designed to be cleaned and reused. These items may last many years if they are good quality and are maintained correctly.

## Maintaining Personal Protective Equipment

When you finish an activity where you are handling pesticides or are exposed to them, remove your personal protective equipment right away. Wash the outside of your gloves with detergent and water **before** you remove them. Consider washing the outside of other chemical-resistant items before you remove them also. This helps you avoid contacting the contaminated part of the items while you are removing them and helps keep the inside surface uncontaminated. If any other clothes have pesticides on them, change them also. Determine whether the items should be disposed of or cleaned for reuse.

Place reusable items in a plastic bag or hamper away from your other personal clothes and away from the family laundry. Place disposables in a separate plastic bag or container. The pesticides remaining on your personal protective equipment, work clothing, and other work items could injure persons who touch them. Do not allow children or pets near them. Do not allow contaminated gloves, boots, respirators, or other equipment to be washed in streams, ponds, or other bodies of water.

Clean all reusable personal protective equipment items

between uses. Even if they were worn for only a brief period of exposure to pesticides during that day, wash them before you wear them again. Pesticide residues that remain on the personal protective equipment are likely to continue to move slowly through the personal protective equipment material, even chemical-resistant material. If you wear that personal protective equipment again, pesticide may already be on the inside next to your skin. Also, personal protective equipment that is worn several times between laundering may build up pesticide residues. The residues can reach a level that can harm you, even if you are handling pesticides that are not highly toxic.

## Washing Personal Protective Equipment

Wash pesticide-contaminated items separately from uncontaminated clothing and laundry. Otherwise, the pesticide residues can be transferred onto the other clothing or laundry and can harm you or your family.

## Alert the persons who do the washing

Be sure that the people who clean and maintain your personal protective equipment and other work clothes know that they can be harmed by touching the pesticide that remains on the contaminated items. Tell them that they should:

- wear gloves and an apron, especially if handling contaminated items regularly or handling items contaminated with highly toxic pesticides.
- work in a well-ventilated area, if possible, and avoid inhaling steam from the washer or dryer.

## Washing procedure

Follow the manufacturer's instructions for cleaning chemical-resistant items. If the manufacturer instructs you to wash the item but gives no detailed instructions, or offers no cleaning instructions at all, follow the procedure below. Some chemical-resistant items that are not flat, such as gloves, footwear, and coveralls, must be washed twice — once to thoroughly clean the outside of the item and a second time after turning the item inside out. Some chemical-resistant items, such as heavy-duty boots and rigid hats or helmets, can be washed by hand using hot water and a heavy-duty liquid detergent. They should be dried and aired as directed below.

The best procedure for washing non-chemical-resistant items, such as cotton, cotton/polyester, denim, canvas, and other absorbent materials, and most chemical-resistant items is:

1. **Rinse** in a washing machine or by hand.
2. **Wash only a few items at a time** so there will be plenty of agitation and water for dilution.
3. **Wash in a washing machine**, using a heavy-duty liquid detergent and hot water for the wash cycle.
4. **Rinse twice** using two entire rinse cycles and warm water.
5. **Use two entire machine cycles** to wash items that are moderately to heavily contaminated.
6. **Run the washer through at least one additional entire cycle** without clothing, using detergent and hot water, to clean the machine after each batch of pesticide-contaminated items, and before any other laundry is washed.

## Drying procedure

**Hang the items to dry, if possible.** It is best to let them hang

for at least 24 hours in an area with plenty of fresh air. Even after thorough washing, some items still may contain pesticides. When the items are exposed to clean air, remaining pesticide residues move to the surface and evaporate. You may wish to buy two or more sets of equipment at a time so you can leave one set airing in a clean place while you are using the other set. Do not hang items in enclosed living areas, because pesticides that remain in the items may evaporate and expose people or animals in the area.

**Using a clothes dryer** is acceptable for fabric items, if it is not possible to hang them to dry. However, over a period of time, the dryer may become contaminated with pesticide residues.

## Maintaining Eyewear and Respirators

Wash goggles, face shields, shielded safety glasses, and respirator bodies and facepieces after each day of use. Use a detergent and hot water to wash them thoroughly. Sanitize them by soaking for at least 2 minutes in a mixture of 2 tablespoons of chlorine bleach in a gallon of hot water. Rinse thoroughly to remove the detergent and bleach. Dry thoroughly or hang them in a clean area to dry.

Pay particular attention to the headbands. Headbands made of absorbent materials should be replaced with chemical-resistant headbands. After each day of use, inspect all headbands for signs of wear or deterioration and replace as needed.

Store respirators and eyewear in an area where they are protected from dust, sunlight, extreme temperatures, excessive moisture, and pesticides or other chemicals.

A zip-closable sturdy plastic bag works well for storage.

Respirator maintenance is especially important. Inspect your respirator before each use. Repair or replace it whenever any part shows sign of wear or deterioration. Maintain an inventory of replacement parts for the respirators you own, and do not try to use makeshift substitutes or incompatible brands. If you keep a respirator for standby or emergency use, inspect it at least monthly and before use.

If you remove your respirator between handling activities:

- Wipe the respirator body and facepiece with a clean cloth.
- Replace caps, if available, over cartridges, canisters, and prefilters.
- Seal the entire respirator in a sturdy, airtight container, such as a zip-closable plastic bag. If you do not seal the respirator immediately after each use, the disposable parts will have to be replaced more often. Cartridges, canisters, prefilters, and filters will continue to collect impurities as long as they are exposed to the air.

At the end of any work day when you wore a reusable respirator:

- Remove the filter or prefilter. Most filters should be discarded. A few are designed to be washed and reused.
  - Take off the cartridges or canisters. Discard them or, if still usable, replace their caps and seal them in an airtight container, such as a zip-closable plastic bag.
  - Clean and store respirator as directed above.
- Discard disposable respirators according to manufacturer's instructions. Do not try to clean them.

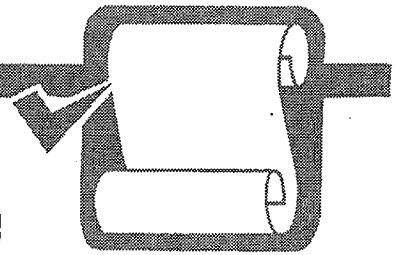

## Test Your Knowledge

**Q.** What legal responsibility do you have for wearing the personal protective equipment that the pesticide labeling lists for your handling situation?

**A.** By law, you must wear at least the personal protective equipment listed on the labeling for the handling task you will be performing. You are allowed to wear additional or more protective personal protective equipment.

**Q.** Define the term “chemical resistant”.

**A.** Chemical resistant: Able to prevent movement of the pesticide through the material during the period of use.

**Q.** How can you tell when a material is not chemical-resistant to the pesticide you are handling?

**A.** The material may change color; become soft or spongy; swell or bubble up; dissolve or become like jelly; crack or get holes; become stiff or brittle.

**Q.** What factors determine how well your coverall will protect your body?

**A.** 1. A coverall is most protective if it fits loosely so there is a layer of air between it and the skin or inner clothing.  
2. A coverall is most protective if it is worn over another layer of clothing, because each layer of clothing adds a protective layer of air as well as a layer of fabric.  
3. Coveralls are most protective if they have tightly constructed

seams and snug, overlapping closures that do not gap or become unfastened readily.

**Q.** When should you wear chemical-resistant gloves? Why are gloves so important to a pesticide handler?

**A.** Wear chemical-resistant gloves any time you may get pesticides on your hands, except for some fumigants whose labeling may direct you not wear gloves. The hands are by far the most likely route of exposure for a pesticide handler.

**Q.** If you need to remove your gloves during the handling activity, what steps should you take to remove them and put them back on?

**A.** 1. Wash gloves thoroughly before taking them off.  
2. Wash hands thoroughly and dry them before putting the gloves on again.

**Q.** Why do pesticides sometimes get on your skin even when you are wearing gloves and protective footwear?

**A.** The items may not be chemical-resistant to the pesticide being handled; they may not be worn correctly; they may not be in good condition; or they may not have been cleaned correctly or replaced soon enough.

**Q.** When should you wear protective headgear? What type of headgear should you use?

**A.** Whenever you may be exposed to pesticides from above, wear protective headgear to help keep pesticides off your head, neck, eyes, mouth, and face. Wear a chemical-resistant hood or wide-brimmed hat. Plastic “safari” hats with plastic sweatbands are a good choice.

**Q.** When the pesticide labeling calls for “protective eyewear,” what should you wear?

**A.** Wear goggles, a face shield, or safety glasses with brow and side shields.

**Q.** What are the differences among dust/mist-filtering respirators, vapor-removing respirators, and air-supplying respirators?

**A.** Dust/mist-filtering respirators are masks or cartridges that filter dust, mists, and particles out of the air around you. Vapor-removing respirators use a cartridge or canister to remove pesticide gases and vapors from the air around you. Air-supplying respirators provide you with clean air either from an air tank or from a location where the air is not contaminated with pesticides.

**Q.** What special hazards do fumigants pose for pesticide handlers?

**A.** Fumigants pose a serious inhalation hazard to pesticide handlers. Some fumigants also can cause severe skin burns if they are trapped next to the skin by tight clothing or chemical-resistant personal protective equipment.

**Q.** If the chemical-resistant gloves you have selected are reusable, how often should you routinely replace them? Under what conditions should you replace chemical-resistant items immediately?

**A.** Throw out most reusable gloves that have been worn for about 5 to 7 days of work. Extra-heavy-duty gloves, such as those made of butyl or nitrile rubber, may last as long as 10 to 14 days. Replace chemical-resistant items immediately if they show any sign of wear or have holes, tears, or leaks.

**Q.** What should you do with a coverall that has highly toxic pesticide concentrate spilled on it?

**A.** Dispose of the coverall. It cannot be adequately cleaned.

**Q.** What should you tell the people who will be laundering your clothing about how to protect themselves from pesticides?

**A.** Tell them to:

1. Wear chemical-resistant gloves and apron, especially if handling contaminated items regularly or handling items contaminated with highly toxic pesticides.

2. Work in a well-ventilated area and do not inhale steam from the washer and dryer.

**Q.** What should you do with your respirator between handling tasks?

**A.** Seal the respirator in a clean, airtight container, such as a sturdy zip-closable plastic bag. If possible, put caps over the opening on the cartridges or canisters.

**Q.** What should you do when you are finished using your respirator for the day?

**A.** 1. Discard any masks, filters, or respirators that cannot be reused.  
2. Take off the prefilters and cartridges or canisters. Discard them or, if still usable, replace their caps and seal them in an airtight container, such as a zip-closable plastic bag.  
3. Wash the respirator body, facepiece, and any reusable filters. Soak them for at least 2 minutes in

a mixture of 2 tablespoons of chlorine bleach in a gallon of hot water. Rinse thoroughly. Dry thoroughly or hang them in a clean area to dry.

4. Store the respirator and any reusable cartridges, canisters, filters, and prefilters in an airtight container in an area where they are protected from dust, sunlight, extreme temperatures, excessive moisture, and pesticides or other chemicals.

**Q.** How will you know when to replace dust/mist masks, prefilters, and dust/mist-filtering and vapor-removing canisters and cartridges?

**A.** 1. Change dust/mist masks, cartridges, and prefilters immediately if you have trouble breathing. They usually need to be changed at least every 8 hours.  
2. Change vapor-removing canisters or cartridges immediately if you smell, taste, or feel irritation from pesticide vapors. Change them whenever any "service life indicator" tells you that you should, or after the time limit set by the manufacturer. Otherwise, replace them after about 8 hours of use.

---

# Pesticide Handling Decisions

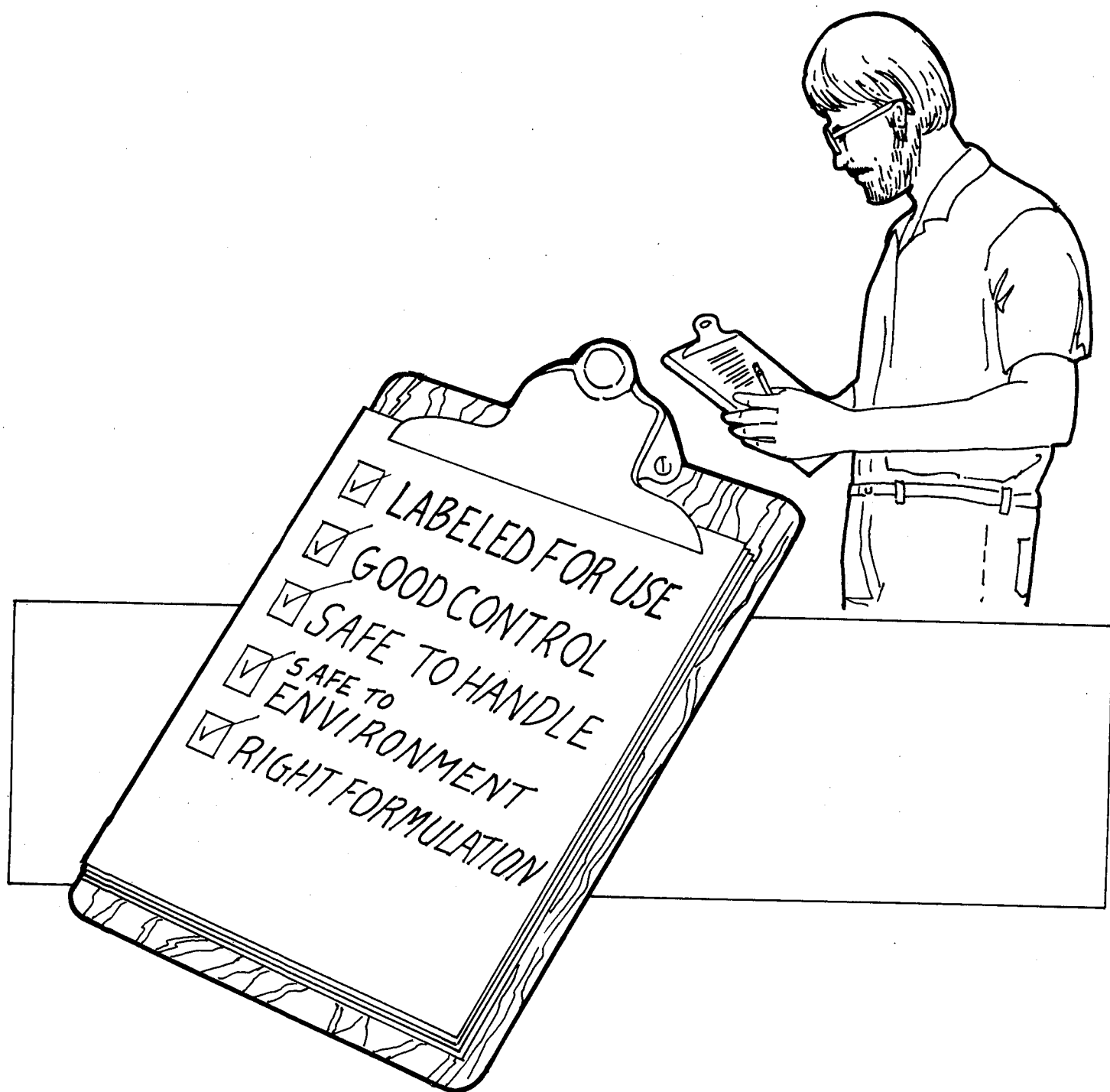

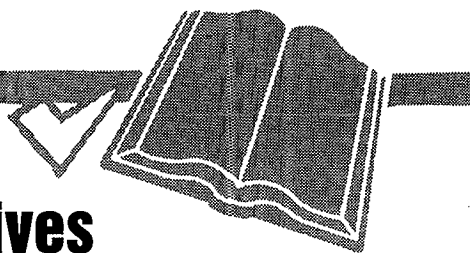
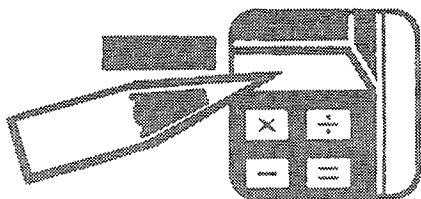

## Learning Objectives

After you complete your study of this unit, you should be able to:

- List basic safety questions you should ask yourself whenever you or those you supervise will be handling pesticides.
- Explain some consequences of incorrect use of pesticides.
- List factors to consider when you have a choice among different types of formulations.
- Name conditions at the application site that may influence some of the decisions you make about the application.
- Describe adjustments you might need to make in the task itself or in the workplace conditions if heat stress is a concern.

## Terms To Know

**Adjuvant** — Chemical added to a pesticide formulation or tank mix to increase its effectiveness or safety.

**Chemical-resistant** — Able to prevent movement of the pesticide through the material during the period of use.

**Concentrates** — Pesticides that have a high percentage of active ingredient.

**Cuticle** — Thin, fatty outer surface on the leaves of some plants.

**Decontamination** — Removal of pesticide from surfaces or organisms that are exposed so no further harm or damage can occur.

**Diluent** — Anything used to dilute a pesticide.

**Dilute** — To make less concentrated.

**Drift** — Pesticide movement away from the release site in the air.

**Emulsifier** — Chemical that allows petroleum-based pesticides (EC's) to mix with water.

**Exposure** — Coming into contact with a pesticide, getting a pesticide on a surface or in or on an organism.

**Eyewash dispenser** — Commercially available system for flushing contaminants out of the eyes.

**Fumigant** — Pesticide that is a vapor or gas or that forms a vapor or gas when applied and whose pesticidal action occurs in the gaseous state.

**Heat stress** — Illness that occurs when the body is subjected to more heat than it can cope with.

**Labeling** — The pesticide product label and other accompanying materials that contain directions that pesticide users are legally required to follow.

**Leaching** — The movement of pesticide in water or another liquid downward through soil or another planting medium.

**Liability** — Legal responsibility.

**Nontarget** — Any site or organism other than the site or pest at which the pesticide is being directed.

**Offsite** — Outside the area where the pesticide is being released.

**Organic matter** — Materials and debris that originated as living plants or animals.

**Penetrant** — Chemical that helps a pesticide active ingredient to get through a surface and into an object or organism.

**Personal protective equipment (PPE)** — Devices and clothing worn to protect the

human body from contact with pesticides or pesticide residues.

**Pesticide handling** — Directly working with pesticides, such as during mixing, loading, transporting, storing, disposing, and applying, or working on pesticide equipment.

**Porous surfaces** — Surfaces that have tiny openings which allow liquid to be absorbed or to pass through.

**Protectant fungicide** — Pesticide applied to prevent the development of some plant diseases caused by fungi.

**Residue** — The part of a pesticide that remains in the environment for a period of time following application or a spill.

**Solvent** — A liquid, such as water, kerosene, xylene, or alcohol, that will dissolve a pesticide (or other substance) to form a solution.

**Systemic pesticide** — Pesticide that is absorbed and circulated by a plant or animal so that the plant or animal is toxic to pests that feed on it.

**Volatile** — Evaporating rapidly; turning easily into a gas or vapor.

**B**efore you do a pesticide handling task, you need to make some important decisions. For **any** pesticide handling activity, you must decide how to ensure the safety of yourself, others, and the environment. Before you **apply** a pesticide, you must make several decisions about how to fit the application to your own pest control situation.

## Personal Safety Considerations

Make safety one of your first concerns every time you handle pesticides or allow someone else to handle them under your supervision. By making a few simple safety decisions, you can prevent many pesticide accidents and reduce the severity of others. Ask yourself these basic safety questions:

### Have I Read the Labeling?

Always read the applicable sections of the pesticide labeling before you open a pesticide container or begin **any** pesticide handling activity. Pesticide labeling contains precautions and instructions that you must follow in order to use the product safely and appropriately. It may contain very specific information that



concerns the task you plan to do. Be sure you understand everything you need to know about the pesticide product before you are exposed to it.

### How Can I Avoid Exposure to Pesticides?

The key to personal safety when handling pesticides is to

avoid exposure to them. Always keep personal clothing, food, drinks, chewing gum, tobacco products, and other belongings away from where pesticides are stored or handled. They could become contaminated and poison or injure you when you use them.

When you take a break, wash your gloves on the outside, remove your gloves, and wash your hands and face thoroughly. Then you can safely chew gum, eat, drink, or smoke, if you wish.

Avoid getting pesticide on yourself when you use the toilet. The skin in the genital area has been shown to absorb more pesticides than any other skin area. Take the time to wash your hands thoroughly before using the toilet, and be careful not to contaminate yourself from pesticides that may be on the outside of your clothing.

Be aware of other situations where you might be exposed to pesticides on the job. Protect yourself not only during mixing, loading, and application, but also during spill cleanup, repairing or maintaining equipment, and when transporting, storing, or disposing of pesticide containers that are open or have pesticides on their outer surface. Use personal protective equipment when necessary to keep pesticides from getting on your skin and in your mouth, eyes, or lungs.

## What Personal Protective Equipment Is Needed?

Decide what personal protective equipment you and the people you supervise will need. You must use what the labeling requires, and you may decide that you need additional equipment. Make sure that the personal protective equipment is clean and in good operating condition.

Be sure that you know how to use the personal protective equipment correctly. Put on and remove the equipment carefully so that you will not come in contact with any pesticides that may be on the outside of it. Do not "cheat" on the personal protective equipment by taking off your gloves to make an equipment adjustment or by pulling your respirator away to scratch your face, wipe off sweat, or take a deep breath while you are still being exposed to the pesticide. Do not wipe your gloves on your clothing; this will contaminate your clothing, and pesticide may move through to your skin.

## Is the Equipment Ready and Safe?

Decide what equipment is necessary for your task. Check to make sure that you have all the equipment you need and that it is clean and in good operating condition. Make sure that anyone who will use the equipment knows how to operate it safely and correctly. Do not allow children, livestock or pets, or unauthorized people to touch the equipment. If they are injured or poisoned, you are responsible.

## Am I Avoiding the Accidental Spread of Pesticides?

Make it a habit to consider how you and those you supervise may



accidentally spread pesticides. You may transfer pesticides to objects, people, and animals when you touch them with gloves that you wore while handling pesticides. When you sit in your car or on a chair while wearing your pesticide-handling outfit, you may

leave pesticides behind. If you step into your office or home to answer a telephone call or use the toilet, you may leave pesticides on surfaces there.

Any time you take home or wear home your work clothing, personal protective equipment, or

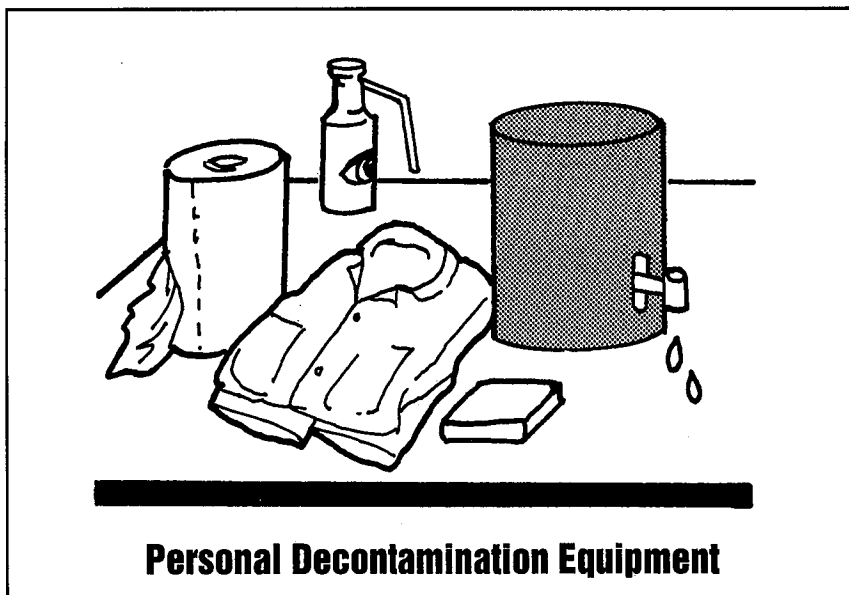

**Personal Decontamination Equipment**



## FIRST AID

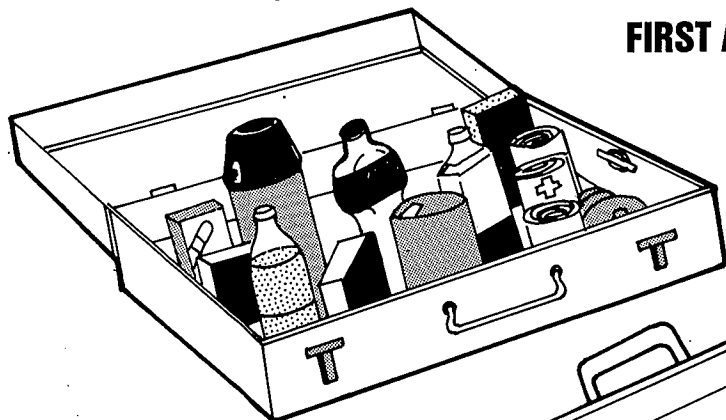

other items that are contaminated with pesticides, the pesticides can rub off on carpeting, furniture, and laundry items, and onto pets and people who come into contact with the contaminated materials. When you do not clean up a spill, no matter how small, other people or animals may get pesticide on themselves without knowing they are being exposed. Pesticides that you spread may harm whoever or whatever touches them.

### Have I Instructed the Handlers I Supervise?

If you supervise other people who handle pesticides, be sure that they are instructed about the personal and environmental hazards of pesticide use. They should know the ways they may be exposed, how to limit pesticide exposure and reduce the risk of heat stress, and how to respond in an emergency. They also should know how to use the pesticide labeling and other sources of information to learn about the pesticide they are using.

Be sure to provide them with specific instructions about the pesticides they will be handling and about the handling duties they will be performing. It is your legal responsibility to make sure that those you supervise are well informed and that they take all the precautions the pesticide labeling requires.

### Am I Prepared for Emergencies?

Before you begin any pesticide handling activity, be sure you are prepared to deal with emergencies such as spills, injuries, and poisonings. Your emergency supplies should include at least:

- **Personal decontamination equipment** — Keep plenty of clean water, detergent, and paper towels nearby in a protected container to allow for fast decontamination in an emergency. Have an extra coverall-type garment nearby in case clothing becomes soaked or saturated with pesticide and must be removed.
- **First aid equipment** — Have a well-stocked first aid kit on hand. It should include a plastic eyewash dispenser that has a gentle flushing action.

## EMERGENCY PPE



## SPILL CLEANUP KIT

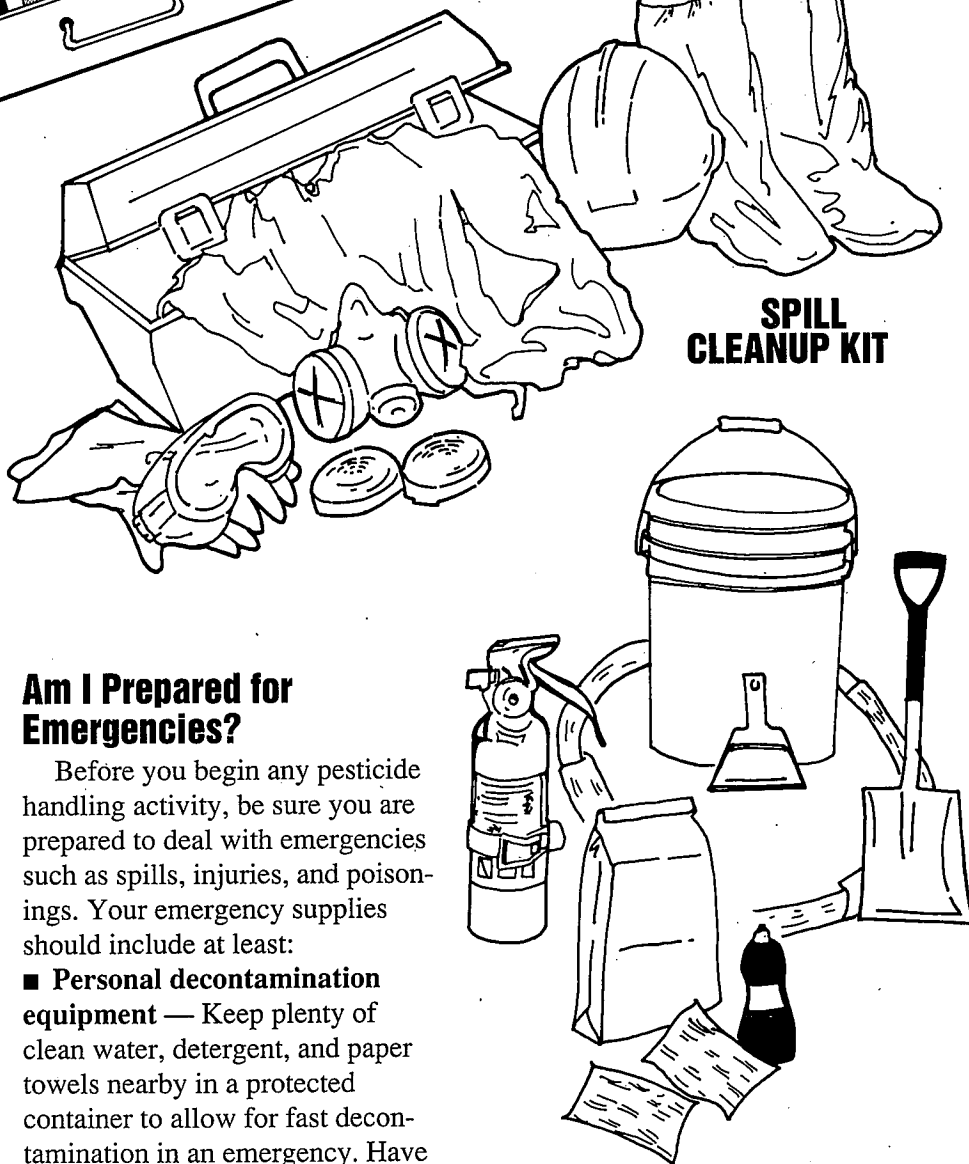

- **Spill cleanup equipment** — Keep a spill cleanup kit on hand at all times. The kit should contain not only all the items needed for prompt and complete spill cleanup, but also personal protective equipment to protect you while you are dealing with the spill.

Know who to call in a medical emergency, and be familiar with the signs and symptoms of poisoning caused by the pesticides you handle. In a poisoning emergency, get the person out of the exposure at once, quickly summon medical assistance, and provide first aid.

## Are People and Animals Out of the Area?

Do not allow anyone but trained and equipped pesticide handlers to be present during any pesticide handling task. You have the legal responsibility to make sure that no one is overexposed to pesticides that you or those you supervise are handling. Always warn workers, supervisors, and any other people who may be near the application site about which sites you plan to treat and how long they must stay out of those sites.

## Pre-Application Decisions

Take the time to think carefully about every pesticide application before you begin. The decisions you make will determine whether you will be using the pesticide safely and correctly. Making the wrong decisions can cause problems:

- Incorrect use can result in wasted material, failure to control the pest, and damage to the target site (the animal, plant, or place to which you were applying the pesticide).
- Misused pesticides can cause immediate as well as long-term harmful effects to humans, to other living things, to property, and to other parts of the environment.
- Misused pesticides can result in fines as well as legal actions



charging you with liability for damages.

- Pesticides are expensive. Using them incorrectly can be costly.

### Choice of Pesticide

One of the first things you must decide is which pesticide to use. Your knowledge of the situation may allow you to make that decision on your own. When in doubt, ask for help in choosing the safest and most effective pesticide for the job. Your pesticide dealer, the Cooperative Extension Service, your trade association, or other experts may be able to help you choose.

### Choice of Formulation

The pesticide you have chosen to apply may be available in several formulations. Each type of formulation has different advantages and disadvantages. Decide which one best fits your needs and the special requirements of your application site. When choosing among formulations, consider the following factors:

### Application site

Some formulations are more likely than others to cause unwanted harm to surfaces, plants, and animals in the application site. Emulsifiable concentrates, for example, tend to pit or stain some surfaces, are easily absorbed through the skin of some animals, and may injure some plants. Dusts and powders are likely to leave a visible residue that may be unacceptable. Fumigant formulations are very likely to injure or kill all plants or animals in the application site.

When pesticides are to be broadcast over large areas, such as in mosquito, biting fly, and forestry pest control, the formulation must be chosen with great care to avoid poisoning nontarget plants and animals in the area.

Typical pesticide labeling statements that alert you to these considerations include:

*Spray droplets will permanently damage automobile paint.*

*Do not apply directly to carpet, as discoloration may occur.*

*Repeated applications may cause the appearance of visible spray residues on foliage.*

*Do not allow spray to contact ferns, hickory, and maples, as injury may result.*

*Do not apply over areas containing exposed food crops.*

*Birds feeding on treated areas may be killed. Cover or incorporate granules.*

*Beekeepers should be warned well in advance to remove hives a safe distance from areas to be treated.*

## **Equipment**

The type of equipment available and in good working condition may limit your choice of formulation. Check to be sure you have all the equipment you need and that it is in good operating condition before you select a particular pesticide formulation.

## **Pesticide movement**

Consider whether runoff is likely to carry the pesticide out of the application site. Granules, pellets, dusts, and other dry formulations that do not require water as a diluent can reduce the risk of runoff.

Consider whether air currents are likely to carry the pesticide away from the application site. If you must apply pesticides when wind or air currents are present, try to choose a formulation or application method that minimizes drift. Avoid dusts, high-pressure sprays, aerosols, and ultra-low-volume formulations. A granular or pellet formulation or a low-pressure spray with coarse droplets would be a good choice. For other types of formulations,

consider using an adjuvant designed to reduce drift, such as a foaming agent, thickener, or sticker.

## **Personal safety**

Some pesticide formulations are more hazardous to people than others. Emulsifiable concentrates and ultra-low-volume concentrates often contain solvents that are hazardous themselves or that allow the pesticide to pass through the skin more quickly. Fumigants and aerosols are easily inhaled. Whenever you have a choice, select the formulation that is least hazardous to the people (or animals) who will be exposed.

Some adjuvants that you mix with your pesticide may increase your risk of exposure. Penetrants and emulsifiers may allow the pesticide to travel through the skin more quickly than usual. Stickers may increase your exposure by causing the pesticide to stick to personal protective equipment, other clothing, and skin. Spreaders and wetting agents may allow the pesticide to spread out more easily, causing the pesticide to contaminate larger areas of skin or personal protective equipment.

## **Target pest**

The type of formulation you select may depend on the pest you are trying to control. Sometimes an entire area must be covered with a pesticide to try to contact each pest. Other pests, however, can be controlled with baits or pesticides placed in a few locations, such as cracks and crevices, at the application site. Fog formulations are useful only for controlling pests present at the time of application. Systemic pesticides are useful for pests that are sucking fluid from or biting into plants or animals.

## **Surface characteristics**

Some pesticide formulations are better suited for use on some types of surfaces than on others. Granules, for example, often provide good control on flat surfaces, but are less useful on surfaces where they are likely to slide or blow off. On a porous surface, consider using a wettable powder rather than an emulsifiable concentrate or oil-base pesticide. The wettable powder formulation will leave more pesticide remaining on the surface.

## **Cost**

Pesticides that are sold as concentrates to be diluted by the user usually are the least expensive and most convenient to purchase and transport. However, these pesticides often mean more risk during mixing and loading than pesticides that are sold already diluted. It is important that the pesticide application be as economical possible, but other factors listed above may be even more important than cost when choosing the most appropriate pesticide formulation.

## **Choice of Application Procedures**

The conditions at the application site will influence some of the decisions you make about the application. Consider factors that affect:

- the effectiveness of the pesticide application,
- the possible effects on you and those under your supervision who are involved in the application, and
- the possible effects on other people and the environment.

## Treated spaces

Some fogging and aerosol applications are used in unenclosed areas outdoors. However, most such pesticide applications are applied to an enclosed space. The space may be a building, hold, or silo, or a smaller enclosure, such as a room or vault. Sometimes you must create the enclosed space by using tarpaulins, sheets of plastic, or other chemical-resistant coverings. Consider whether these treated spaces are sealed well enough to prevent the pesticide from escaping too quickly when it is applied. If the enclosed space is not sealed well, consider using a different application method or taking steps to improve the seal. You may need to tighten openings, cover air vents, or fasten the covering more securely at the base.

## Soil surfaces

If you are directing a pesticide application at a soil surface, consider the characteristics of the soil at the application site. Organic matter in soils may “tie up” pesticides, limiting their activity. Some pesticide labeling will allow you to use higher rates on soils with high organic matter. Soil texture also affects the way pesticides work. Soils with fine particles (silts and clays) have the most surface area. The labeling may direct you to use higher rates for total coverage. Coarser soils (sands) have less surface area and may allow you to use lower rates.

Typical pesticide labeling statements that alert you to these considerations include:

*In soils over 10% organic matter, use highest rate given.*

*Use the lowest rate for coarser textured (light) soils or soils with lower organic matter. Use a*

*medium rate on medium textured soils or soils containing more than 5% organic matter. Use the highest rate for fine textured (heavy) soils or soils containing more than 10% organic matter.*

## Plant surfaces

Pesticides tend to bounce or run off narrow, upright leaves. Broad, flat leaves tend to hold the pesticide longer. Foliar sprays may be prevented from entering the leaf by a thick wax and cuticle layer. The waxy surface also tends to cause a spray solution to form droplets and run off the leaves.

A dense layer of leaf hairs may hold the pesticide droplets away from the leaf surface, causing uneven distribution on the surface and allowing less chemical to be absorbed into the plant. However, a thin layer of leaf hairs may allow more even distribution on the surface and may cause the chemical to stay on the leaf surface longer than normal, allowing more chemical to be absorbed into the plant.

Typical pesticide labeling statements that alert you to these considerations include:

*Add spreader-sticker when applying to smooth or waxy surfaces.*

*For best results on emerged weeds, add a surfactant and apply as a directed spray.*

*In difficult wetting situations, such as mature waxy foliage, use the higher rate.*

## Other surfaces

**Porous surfaces** such as wood, concrete, and fabric may absorb pesticides (especially liquid or gas applications) readily. If your objective is to saturate the material with pesticide, porous surfaces are

an advantage. However, if the pesticide must remain on the surface to be effective, porous surfaces may require more pesticide to gain effective control. Pesticides may bounce or run off **nonporous surfaces**, making it difficult to achieve an even coverage.

Applying pesticides so that they remain on **upright and slanted surfaces** is also difficult. Consider using adjuvants, such as stickers, that help the pesticide cling to the treated surface.

Typical pesticide labeling statements that alert you to these considerations include:

*Use the lower rate on nonporous surfaces and the higher rate on porous surfaces.*

*Activity on porous surfaces may be limited.*

The **cleanliness of the surface** may also affect the effectiveness of a pesticide application. An accumulation of organic matter on the soil surface may absorb many pesticides and reduce the amount available to control the target pest. For applications to surfaces other than soil, excess dust and dirt may prevent some of the pesticide from reaching the surface being treated. Consider removing these materials from the application site before you apply the pesticide.

Typical pesticide labeling statements that alert you to these considerations include:

*Remove existing plant material from surface before application.*

*Application should be made to clean surfaces.*

*Before application, clean up waste materials, dust, dirt, and all other debris.*

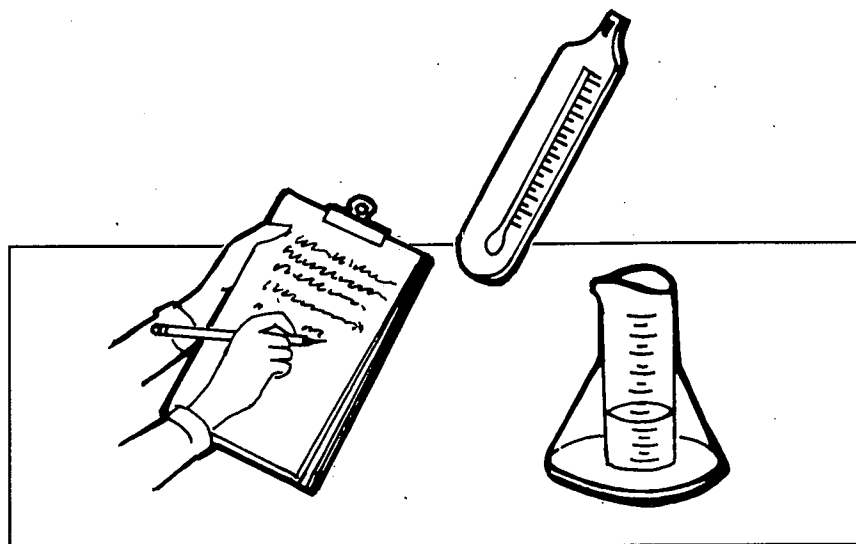

*When applied to properly prepared soil, the liquid is converted into a gaseous fumigant.*

*Do not breathe vapors or fumes.*

These statements provide you with an important clue that the pesticide is volatile and that you should take precautions to keep it from vaporizing and moving offsite. When the pesticide is applied as a spray, consider reducing the volatility by decreasing the pressure and increasing the droplet size.

### Surface moisture

Pesticides often work best with moderate surface moisture. Too much wetness may keep the pesticide from adequately contacting the surface. Dryness may prevent the pesticide from spreading evenly over the surface and contacting the target pest.

A typical pesticide labeling statement that alerts you to this consideration is:

*Most effective when good surface moisture conditions exist.*

### Temperature, sunlight, and humidity

Temperature may influence the effectiveness of some pesticide applications. **Low temperature** slows down or stops the activity of some pesticides. Low temperature also affects some pests by making them move about less, eat less, or change into another form. These pests may be less susceptible to some pesticide applications. A typical pesticide labeling statement that alerts you to this consideration is:

*Do not apply when temperatures are below 50 °F.*

**High temperature and direct sunlight** will influence the effectiveness of some pesticide applications. They cause some pesticides left exposed on top of surfaces to break down before there is adequate control of the pest. A typical pesticide labeling statement that alerts you to this consideration is:

*Do not apply when temperatures are above 95 °F.*

**High temperature**, especially combined with **low humidity**, increases the likelihood that some pesticides will vaporize. Once in vapor form, pesticides can drift from the original application site and settle onto nontarget areas. When you are applying pesticides that you know or suspect can vaporize easily, consider the temperature conditions at the application site. Typical pesticide labeling statements that alert you to this consideration include:

*At high air or surface temperatures, vapors from this product may injure susceptible plants.*

**Humidity** also influences the effectiveness of some pesticide applications. For example, herbicides often work best when weeds are growing fast — usually in high humidity and optimum temperature. However, these same conditions may make the protected plant more likely to be injured by herbicides. A typical pesticide labeling statement that alerts you to this consideration is:

*Apply when conditions are favorable for weed growth.*

### Rain or irrigation water

In some pest control situations, you must consider whether rain or other watering will occur during or soon after a pesticide application. Sometimes such watering is helpful. Some pesticides that are applied to porous surfaces, especially soil, must be carried by water into the surface. Thorough watering also is needed to start the pesticide action after the application of some granular pesticides. Some protectant fungicides are designed to be applied to plants during or just before an expected rain or watering.

Typical pesticide labeling statements that alert you to these considerations include:

*Apply just before a light rain or water lightly after application to wash chemical down to soil.*

*Begin applications when dew or rain occur and disease threatens.*

Most pesticide applications, however, should not be made during or just before rain or watering. Rain, irrigation water, or other water that wets the surface soon after a surface application may interfere with pest control by washing off the pesticides or by causing them to leach downwards away from the surface. For outdoor applications, check the forecast and make your own weather observations. For applications to plants, check for an irrigation or watering schedule.

Typical pesticide labeling statements that alert you to these considerations include:

*Application may have to be repeated if rain occurs shortly after application.*

*Following application, and during rainfall events that cause runoff, this chemical may reach surface water bodies including streams, rivers, and reservoirs.*

*Avoid wash-off of sprayed foliage within 6 hours of application.*

### **Air movement**

Air movement from wind or ventilation can greatly alter the effectiveness of a pesticide application. Too much air movement can blow the pesticide off target and result in inadequate control. The amount of air movement that is acceptable depends on the type of formulation and

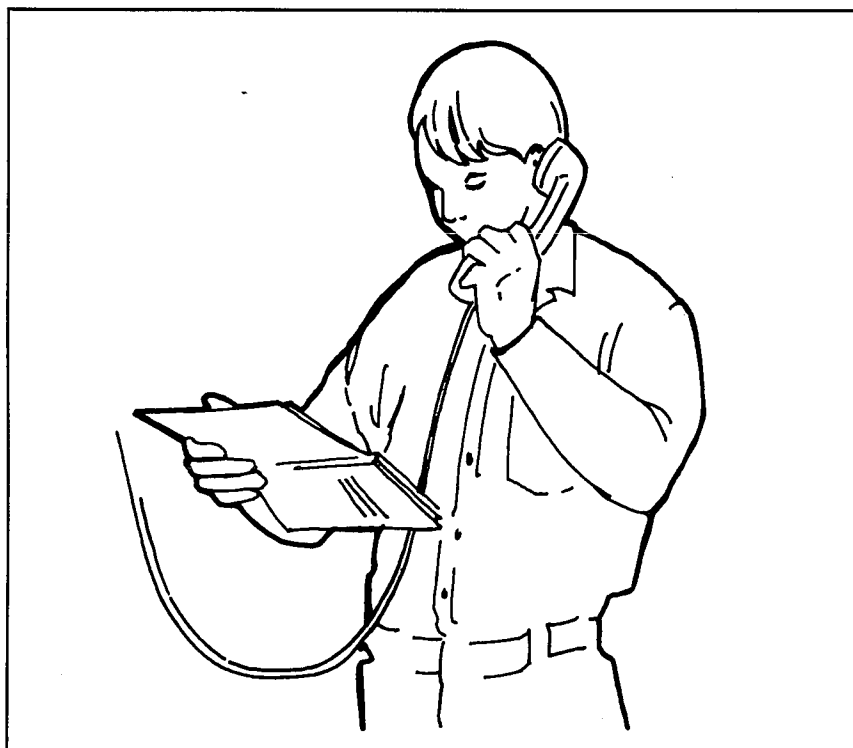

application technique you will be using. As a rule of thumb, the farther from the target surface a pesticide is applied, the less air movement is acceptable.

Typical pesticide labeling statements that alert you to these considerations are:

*Do not apply when weather conditions favor drift from treated areas.*

*Do not apply with aerial equipment when wind speed is greater than 10 mph.*

*Coarse sprays are less likely to drift; therefore, do not use nozzles or nozzle configurations which dispense spray as fine droplets.*

Sometimes you can offset air movement by allowing the air to blow the pesticide towards the area to be protected. You may be able to arrange for the ventilation system to be turned off during indoor applications.

### **Scheduling Pesticide Applications**

Each pesticide application involves a different set of conditions. Your responsibility is to assess the conditions and decide when to apply the pesticide and whether to take any special precautions.

Sometimes you have no choice about when to schedule a pesticide application. In those situations, you must be careful to apply the pesticides safely under the existing conditions. If you have a choice about when an application can take place, consider applying during off-hours. Applying pesticides during very early morning hours, in the evening, or even at night — both in outdoor situations and indoors in greenhouses, malls, office buildings, and other nonresidential structures — has several advantages:

- It is less likely that people other than pesticide handlers will be nearby.

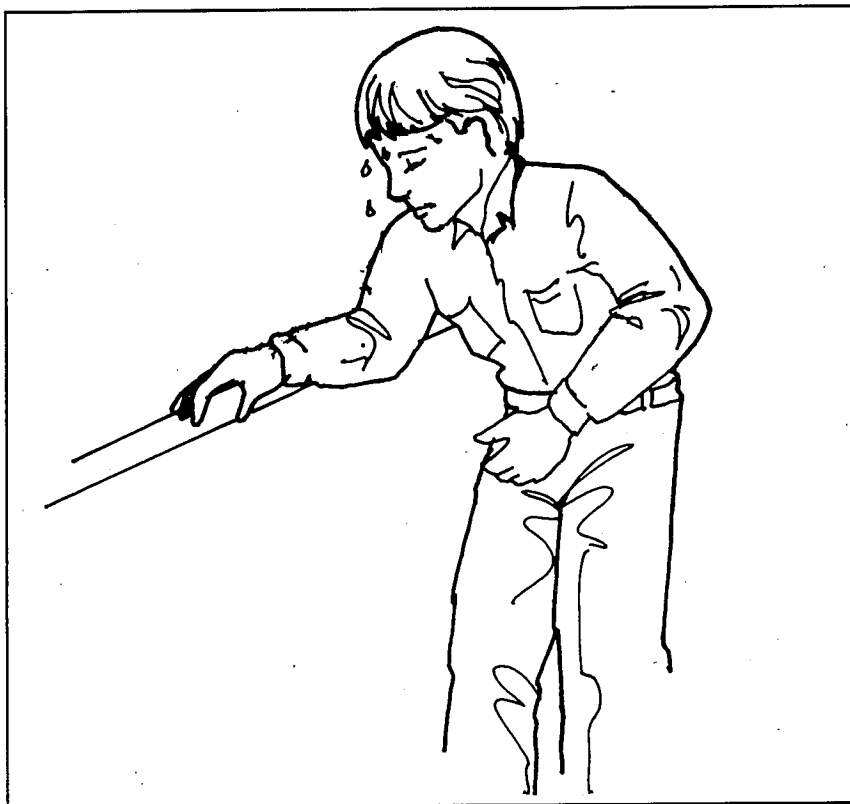

- It is more likely to be cooler, reducing concerns about heat stress and pesticide vaporization.
- The wind is likely to be low, and indoor ventilation systems may be off or reduced.
- There will be no direct sun in outdoor and glass-roofed sites.

If you do choose to work during off-hours, have another person check on you often. Work only where there is enough light to allow you to apply the pesticide correctly and accurately.

## Avoid Heat Stress

Several factors work together to cause heat stress. Before you begin a pesticide handling task, think about whether any of these factors are likely to present a problem. Consider what adjustments you may need to make in the task itself or in the workplace conditions, including:

- heat factors — temperature, humidity, air movement, and sunlight,

- workload,
- personal protective equipment,
- water,
- scheduling adjustments.

## Heat Factors and Workload

High temperatures, high humidity, and direct sunlight increase the likelihood that heat stress will occur. Air currents provide a cooling effect. Because hard work causes the body to produce heat, you are more likely to develop heat-related illness when you are working on foot than when you are driving a vehicle or flying an aircraft. You are even more likely to become overheated while lifting or carrying heavy containers or equipment.

- Use fans and ventilation systems and provide shade whenever possible to reduce the heat. A work area or vehicle sometimes can be shaded by a tarp or canopy or provided with fans.

- Allow time for adjustment to the heat factors and workload. People who have become used to working in the heat are less likely to be affected by heat stress. To become adjusted to hot work environments, do short periods of light work in the heat for several days in a row; then gradually increase the work period and the workload for the next several days.

- Schedule frequent breaks when the heat stress risk is high.

## Personal Protective Equipment

Pesticide handling tasks often require that you wear extra layers of clothing or chemical-resistant suits and other protective equipment. This equipment keeps pesticides from getting on the skin, but it also interferes with the natural body cooling that happens when sweat evaporates from the skin. You can get overheated very quickly when you are wearing personal protective equipment.

- Choose personal protective equipment designed to be as cool as possible or to provide a cooling effect, such as a powered air-purifying respirator or, when appropriate, back-vented coveralls.

- Increase the shade or cooling by use of devices such as awnings, fans, air conditioners, and cooling vests.

## Water

Evaporation of sweat from the skin helps to cool the body and maintain a constant core temperature. Under the conditions that may lead to heat stress, the body produces a large amount of sweat. Unless the water that is lost in sweat is replaced, the body can no longer regulate its temperature

correctly. Under conditions of high temperature, strong air currents, heavy workload, or direct sunlight, a loss of as much as 1 gallon of water per hour is possible.

- Make a special effort to drink plenty of water or “sports drinks” during heat stress conditions. Do not rely on a feeling of thirst to tell you whether your body has enough water. You can lose a dangerous amount of water even before you begin to feel thirsty. You also may stop feeling thirsty long before you drink enough fluids to replace what you have lost.

- Drink plenty of water before and after work.

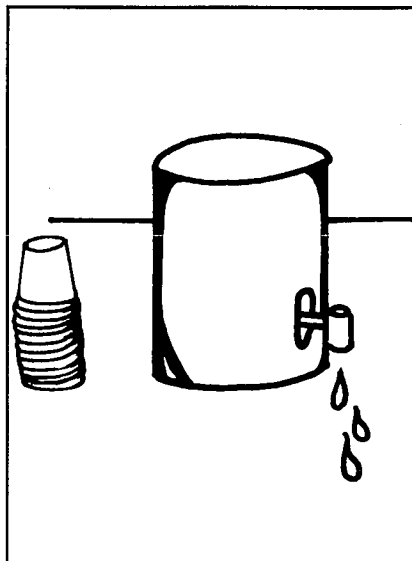

### **Scheduling Adjustments**

By taking the above steps, you will prevent most heat stress

problems. But you must be ready for times when, regardless of your efforts, you or the handlers you supervise get dangerously hot. When this happens, you must:

- Adjust work/rest cycles — Decrease the length of work periods and increase the length of rest periods.

- Try to schedule tasks requiring the heaviest workload or the most personal protective equipment during the coolest part of the work day.

- Stop work — Under extremely hot conditions when you cannot use cooling devices, you may need to stop work until conditions improve.



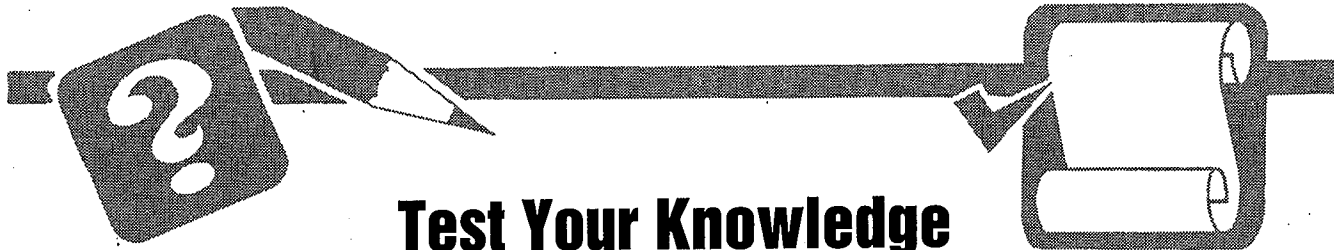

## Test Your Knowledge

**Q.** What eight basic safety questions should you ask yourself whenever you or those you supervise will be using pesticides?

**A.**

1. Have I read the labeling?
2. How can I avoid exposure to pesticides?
3. What personal protective equipment is needed?
4. Is the equipment ready and safe?
5. Am I avoiding the accidental spread of pesticides?
6. Have I instructed the handlers I supervise?
7. Am I prepared for emergencies?
8. Are people and animals out of the area?

**Q.** List some consequences of the incorrect use of pesticides.

**A.**

1. Incorrect use can result in wasted material, failure to control the pest, and damage to the target site.

2. Misused pesticides can cause immediate as well as long-term harmful effects to humans, to other living things, to property, and to other parts of the environment.

3. Misused pesticides can result in fines as well as legal actions charging you with liability for damages.

4. Pesticides are expensive. Using them incorrectly can be costly.

**Q.** Name at least four factors that you should consider when you must choose among different formulations.

**A.**

1. Whether the formulation will cause unwanted harm to plants, animals, or surfaces in the application site.

2. Application equipment available and best suited for the job.

3. Hazard of drift or runoff (likelihood of air currents or excess water).

4. Risk to applicator, workers, and other people and animals likely to be exposed.

5. Habits or growth patterns of the pest.

6. Surface to which the pesticide is to be applied.

7. Cost considerations.

**Q.** Name four conditions at the application site that may influence some of the decisions you make about the application.

**A.**

Type of space or surface to be treated; surface cleanliness; surface moisture; temperature; humidity; presence of direct sunlight; possibility of rain or watering; air movement.

**Q.** If heat stress is a concern when you schedule a pesticide application, what five factors might you need to adjust?

**A.**

Heat factors, workload, personal protective equipment, amount of water consumed, and the work schedule.



# Mixing, Loading, and Application

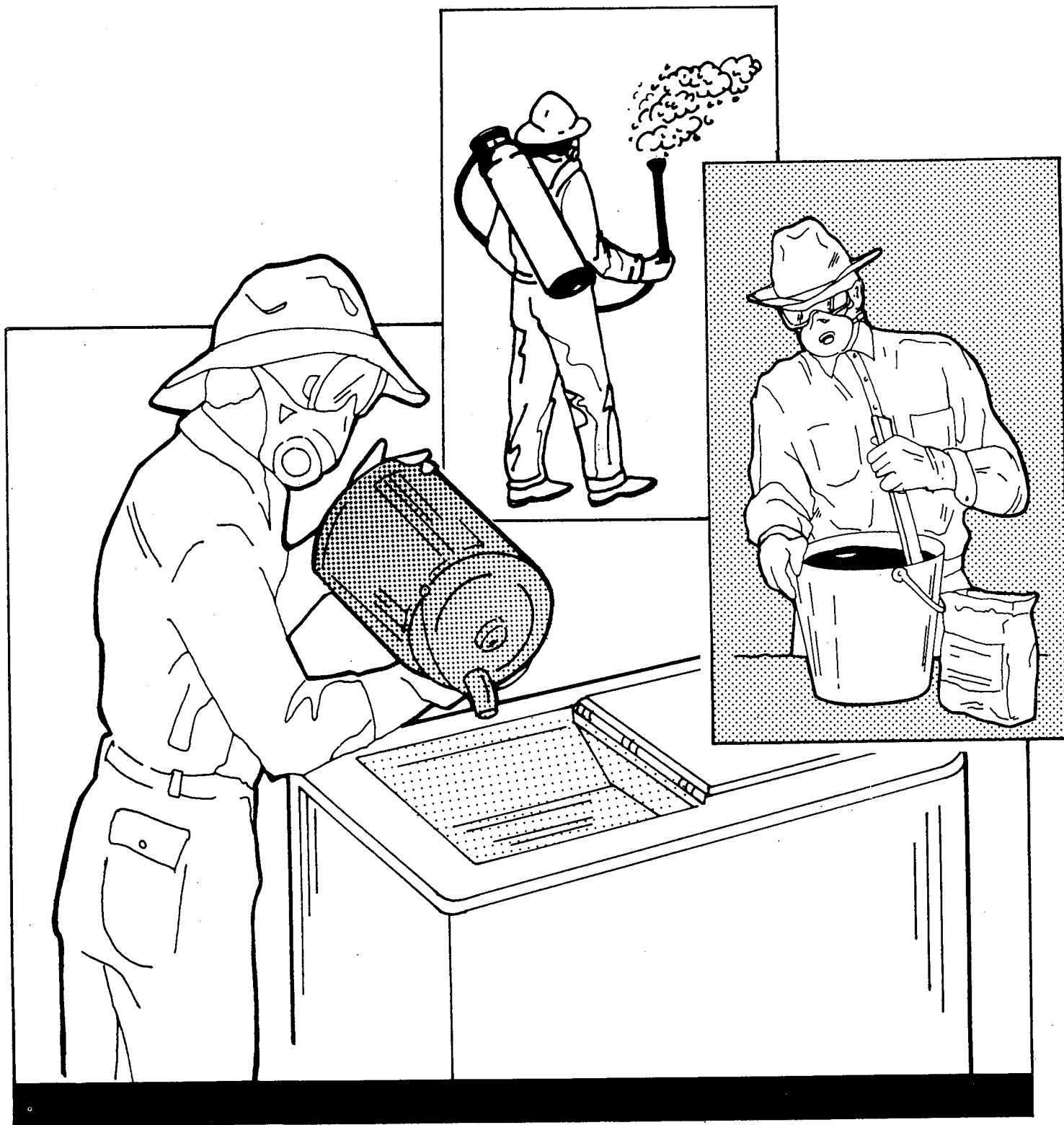

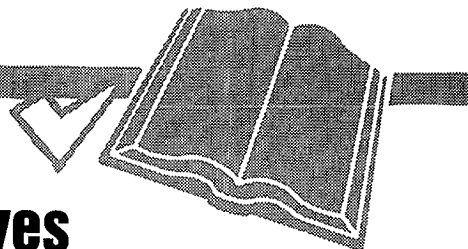
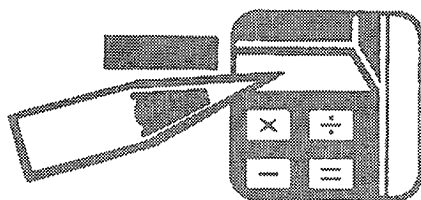

## Learning Objectives

After you complete your study of this unit, you should be able to:

- Describe how to protect the water source at the mixing site.
- Name types of protection you may need while mixing or loading pesticides.
- Explain what to do with empty pesticide containers.
- Name types of empty containers that can be rinsed, and describe rinsing methods.
- Describe ways to determine whether two pesticides can be safely mixed together for application.
- Name some pesticide application tasks for which you may need to wear more personal protective equipment than the minimum required by the pesticide labeling.
- Name actions to take when mixing, loading, and application activities are over.
- Describe what to do with rinsates from equipment cleanup.
- Describe personal cleanup after pesticide handling.
- List some benefits of record-keeping.
- Explain “closed system mixing and loading” and “enclosed application systems”.
- Explain when pesticide collection systems are appropriate, and list advantages of such systems.

## Terms To Know

**Active ingredients** — The chemicals in a pesticide product that control the target pest.

**Acute effects** — Illnesses or injuries that may appear immediately after exposure to a pesticide (usually within 24 hours).

**Adjuvant** — Chemical added to a pesticide formulation or tank mix to increase its effectiveness or safety.

**Agitate** — To stir or mix.

**Alkaline** — The opposite of acidic; having a Ph greater than 7.

**Back-siphoning** — The movement of liquid pesticide mixture back through the filling hose and into the water source.

**Chemical-resistant** — Able to prevent movement of the pesticide through the material during the period of use.

**Collection pad or tray** — A safety system designed to contain and recover spills, leaks, rinsates, and other pesticide-containing substances.

**Concentrates** — Pesticides that have a high percentage of active ingredient.

**Delayed effects** — Illnesses or injuries that do not appear immediately (within 24 hours) after exposure to a pesticide or combination of pesticides.

**Diluent** — Anything used to dilute a pesticide.

**Dilute** — To make less concentrated.

**Drift** — Pesticide movement away from the release site in the air.

**Exposure** — Coming into contact with a pesticide; getting a pesticide on a surface or in or on an organism.

**Formulation** — Pesticide product as sold, usually a mixture of active and inert ingredients.

**Fumigant** — Pesticide that is a vapor or gas or that forms a vapor or gas when applied and whose pesticidal action occurs in the gaseous state.

**Labeling** — The pesticide product label and other accompanying materials that contain directions that pesticide users are legally required to follow.

**Leaching** — The movement of pesticide in water or another liquid downward through soil or other planting medium.

**MSHA** — Mine Safety and Health Administration.

**NIOSH** — National Institute for Occupational Safety and Health.

**Nontarget** — Any site or organism other than the site or pest at which the pesticide is being directed.

**Personal protective equipment (PPE)** — Devices and clothing worn to protect the human body from contact with pesticides or pesticide residues.

**Pesticide handling** — Directly working with pesticides, such as during mixing, loading, transporting, storing, disposing, and applying, or working on pesticide equipment.

**Porous surfaces** — Surfaces that have tiny openings which allow liquid to be absorbed or to pass through.

**Release** — When a pesticide leaves its container or the equipment or system that is containing it and enters the environment. Release can be intentional, as in an application, or by accident, as in a spill or leak.

**Rinsate** — Pesticide-containing water (or another liquid) that results from rinsing a pesticide container, pesticide equipment, or other pesticide-containing articles.

**Runoff** — The movement of pesticide away from the release site in water or another liquid flowing horizontally across the surface.

**Scouting** — Regularly searching for, identifying, and assessing numbers of pests and the damage they are causing.

**Sensitive areas** — Sites or organisms that are particularly vulnerable to harmful effects from pesticides.

**Soluble** — Able to be dissolved in another substance, usually a liquid.

**Solvent** — A liquid, such as water, kerosene, xylene, or alcohol, that will dissolve a pesticide (or other substance) to form a solution.

**Target pest** — The pest toward which control measures are being directed.

**Toxicity** — Measure of a pesticide's ability to cause acute, delayed, or allergic effects.

**M**ixing, loading, and application are the primary pesticide handling tasks. They are also among the most hazardous aspects of a handler's job. Never try to cut corners where safety is concerned, and do not assume that every job will be like every other. For example, even though you are familiar with a pesticide, take the time to read the labeling again each time you buy the product — important directions are changing more often than in the past, and new information may have been added.



## Safe Mixing and Loading Practices

Pesticide handlers are most often exposed to harmful amounts of pesticides when mixing or loading concentrated pesticides. Handlers who mix and load concentrated pesticides with high acute toxicity have an especially high risk of accidental poisoning. By observing some simple precautions, you can reduce the risks involved in this part of your job.

### Select an Appropriate Area

Choose the pesticide mixing and loading area carefully. It should be outdoors or in a well-

ventilated area away from unprotected people, animals, food, other pesticides, and other items that might be contaminated. Choose a place with good light, especially if you are working at night. Be particularly careful not to mix or load pesticides indoors unless lighting and ventilation are adequate.

### Protect Your Water Source

Protect your water source by keeping the water pipe or hose well above the level of the pesticide mixture. This prevents contamination of the hose and keeps pesticides from back-

siphoning into the water source. If you are pumping water directly from the source into a mix tank, use a check valve, antisiphoning device, or backflow preventer to prevent back-siphoning if the pump fails. Backflow prevention devices are required by law in some areas.

Avoid mixing or loading pesticides in areas where a spill, leak, or overflow could allow pesticides to get into water systems. When mixing situations require you to use water from a faucet, well, stream, pond, or other water system, take special precautions. Place your mixing equipment where spills, leaks, and

overflows will not flow towards a drain or into the water supply. If necessary, install dikes or other barriers, or grade the soil to divert the flow. If you will be mixing or loading at the site often, consider installing a collection pad or tray.

Typical pesticide labeling statements that alert you to these concerns include:

*Care must be taken when using this product to prevent back-siphoning into wells. Check valves or antisiphoning devices must be used on all mixing and/or irrigation equipment.*

*Do not spill or empty into streams, ponds, or any other body of water.*

*Equipment should be equipped with automatic shutoff devices and valves to prevent backflow into the water source.*

## Personal Protective Equipment

Before opening a pesticide container, you and those you supervise must put on the appropriate personal protective equipment. By law, you must use all of the personal protective equipment that the pesticide labeling requires for mixers and loaders. Consider using additional personal protective equipment in certain mixing and loading situations.

### Front protection

If you may be splashed during mixing or loading tasks, or if you will need to lean against contaminated equipment during mixing or loading, consider wearing a bib-top apron made of butyl, nitrile, or foil-laminate material. The style of apron that includes built-in gloves and sleeves is especially protective. An apron:

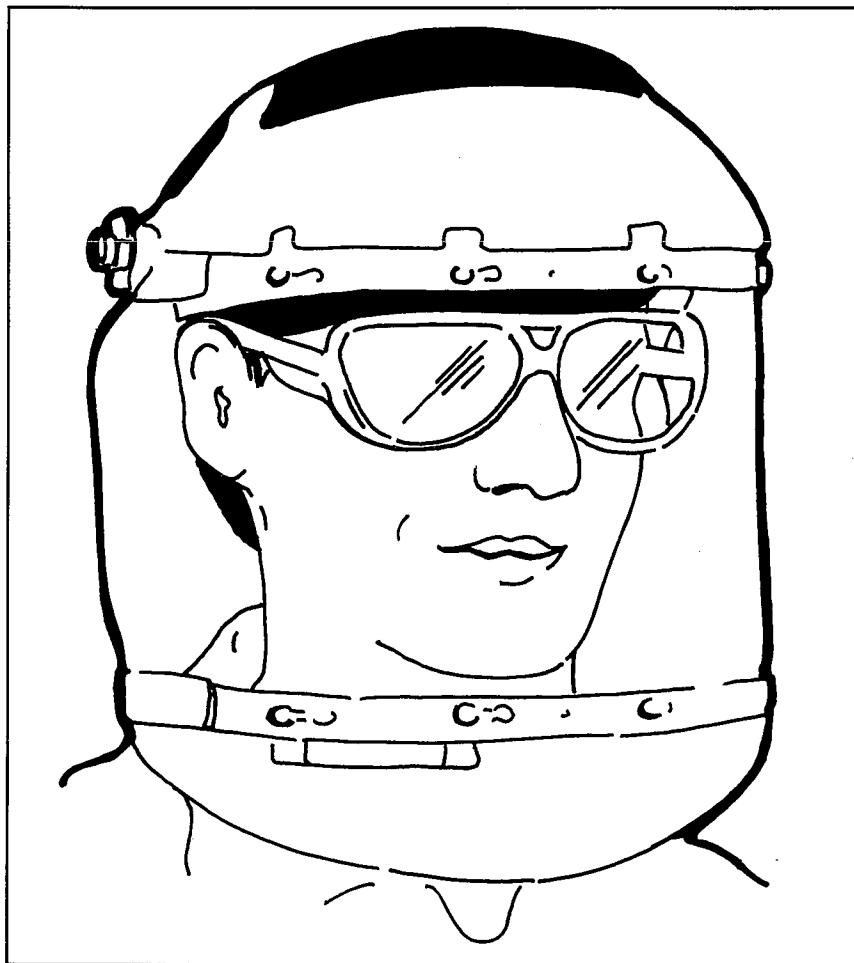

- keeps pesticides off the front of your clothing,
- is cooler than a chemical-resistant protective suit, and

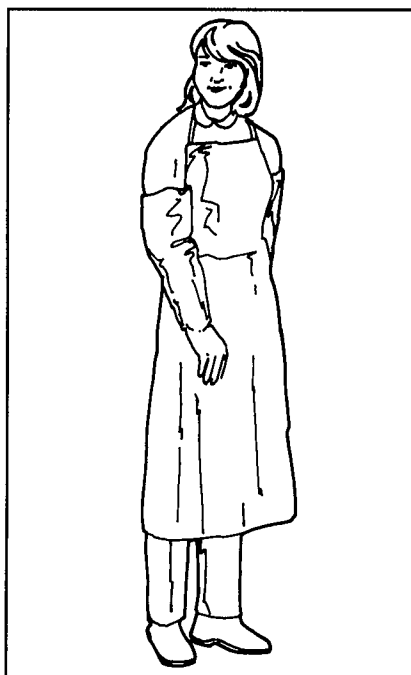

- is easily removed at the end of the activity.

### Face protection

If you will be pouring liquid pesticide or adding dry pesticide to a liquid, consider wearing a face shield to keep splashes and wafting dusts off your face and out of your nose and mouth. A face shield is easy to put on, take off, and clean at the end of the day. If you need to wear a respirator, goggles or shielded safety glasses will fit better than a face shield.

### Protection from dusts

When you will be pouring dusts for long periods of time or working under conditions where dusts might swirl up into your face, consider wearing a dust/mist filtering respirator to keep from

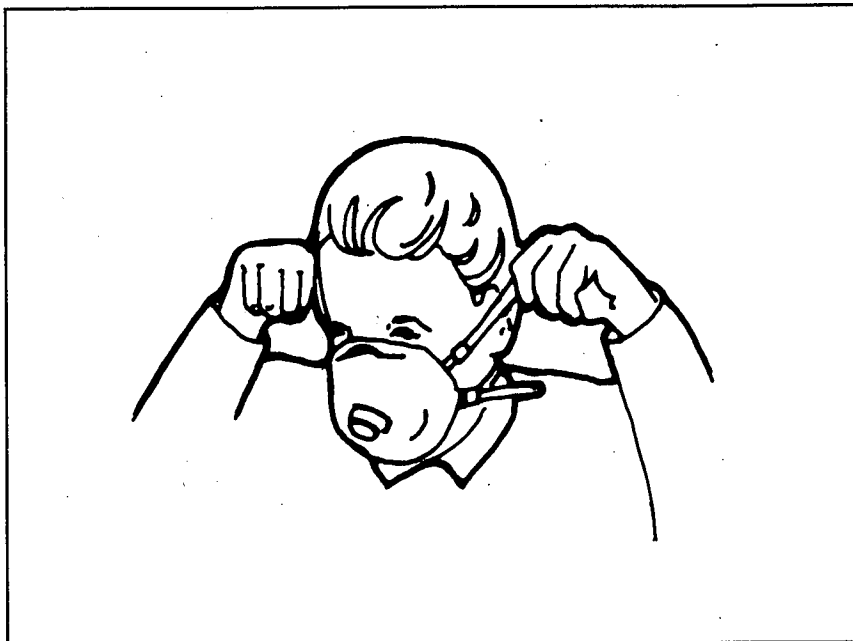

inhaling the dusts. Choose a dust/mist respirator with NIOSH/MSHA approval. Also wear eye protection, such as shielded safety glasses, goggles, or a face shield, to keep the dusts out of your eyes.

### **Protection from vapors**

If you will be handling pesticides that produce vapors that cause your eyes, nose, or throat to sting or that cause you other discomfort, wear eye protection and a vapor-removing respirator with NIOSH/MSHA approval.

### **Opening Containers**

Do not tear paper or cardboard containers to open them. Use a sharp knife. Clean the knife afterwards, and do not use it for other purposes. Open containers of pesticides only when they are sitting on a flat, stable surface. If they are tipped on an angle or are in an unstable position, they can easily spill over or leak out when the seal is broken.

### **Transferring Pesticides**

When pouring any pesticide from its container, keep the

container and pesticide below face level. This will avoid a splash, spill, or dust from getting on your face or into your eyes and mouth. If there is a wind outdoors or a strong air current indoors, stand so the pesticide cannot blow back on you.

If you are siphoning the pesticide from the container to the tank, never use your mouth to get the siphon started. You could easily get a mouthful of pesticide.

### **Spills**

To prevent spills, close containers after each use. Even if you plan to mix more pesticide soon, close the container tightly each time. Never leave a tank unattended while it is being filled. It may overflow and contaminate the area.

If you splash or spill a pesticide on yourself while mixing or loading, stop right away and remove your contaminated clothing. Wash thoroughly with a mild liquid detergent (or soap) and water as quickly as possible. Put on clean personal protective equipment. Then clean up the spill.

## **Empty Pesticide Containers**

Even after it appears that all the pesticide product has been removed from a container, it usually is not truly empty. The pesticide that clings to the inside of the container can be dangerous to you, other people, and the environment. Take care of empty containers at once.

If containers are rinsable, rinse them as soon as they are empty. Return all pesticide containers to the pesticide storage area or the container holding area when you finish your task. Do not leave them unattended at the mixing, loading, or application site. Never give pesticide containers to children to play with or to adults to use.

If you have empty pesticide containers that cannot be refilled, reconditioned, recycled, or returned to the manufacturer, crush, break, or puncture them. This will make the containers unusable and may also save storage space. Dispose of containers in accordance with label directions and with Federal, State, tribal, and local laws and regulations. For more specific information on how to dispose of containers, see "Transportation, Storage, Disposal, and Spill Cleanup."

### **Nonrinsable containers**

You may not be able to rinse bags, boxes, and other containers of dry pesticides, because the container will not hold up to the rinsing. You also may not be able to rinse containers of ready-to-use pesticides, because there is no place to put the rinsate. The pesticide labeling may tell you not to rinse certain types of containers. These containers may be designed

to be returned to the pesticide dealer or manufacturer for rinsing. Containers that cannot or should not be rinsed must be emptied as completely as possible. Shake or tap the container to remove as much of the pesticide product as you can. Drain containers of liquid pesticides for at least an additional 30 seconds.

### Rinsable containers

When you are diluting pesticides, you should rinse the empty pesticide containers, unless the labeling directs you not to. Rinse containers as soon as they are empty, because the remaining residues can dry quickly and become difficult to remove. Such rinsing often saves money, because each rinse removes pesticide from the sides and bottom of the container and allows you to add it to the pesticide mixture.

If you rinse empty pesticide containers thoroughly, you usually can dispose of them as nonhazardous waste. Rinsed containers that are to be stored for later disposal should be clearly marked to indicate that they have been rinsed. There are stickers commercially available for this purpose.

Glass, metal, and plastic containers, plastic-lined paper or cardboard containers, and even unlined paper or cardboard containers that can withstand the rinsing process should be triple rinsed or pressure rinsed. The liquid you use for rinsing should be the diluent (water, kerosene, high-grade oil, or another liquid) listed on the pesticide labeling for diluting the pesticide for application. After rinsing, add the rinsate to your pesticide mixture.



**Pressure rinsing** is an alternative to triple rinsing. Some pesticide equipment, including some closed system mixing and loading equipment, is equipped with a mechanism to pressure rinse pesticide containers when they are emptied. The system usually operates by:

- inserting a high-pressure nozzle and hose into the container,

- rotating the nozzle and rinsing for at least 30 seconds, and
- draining the container thoroughly into the mix tank.

Some systems puncture the base or side of the container to insert the nozzle. Other systems insert the nozzle into the container's regular opening.

Typical pesticide labeling instructions about emptying containers include:

#### To triple rinse a container:

1. Empty the container into the tank. Let it drain an extra 30 seconds.
2. Fill it one-fifth to one-fourth full of water.
3. Replace the closure and rotate the container for about 30 seconds. Invert the container so the rinse reaches all the inside surfaces.
4. Drain the rinse water from the container into the tank. Let the container drain for 30 seconds.
5. Repeat steps 2 through 4 two more times for a total of three rinses.



*Triple rinse containers and dispose of rinsate in area just treated.*

*Triple rinse (or equivalent).*

*Completely empty bag into application equipment.*

*Triple rinse original container with fuel oil, kerosene or a similar type of petroleum solvent and dispose of rinsate by incorporation into the area just treated or by other approved means.*

## Combining Pesticides

Pesticide handlers often like to combine two or more pesticides and apply them at the same time. Such mixtures can save time, labor, and fuel. Manufacturers sometimes combine pesticides for sale as a pre-mix, but pesticide handlers also sometimes combine pesticides at the time of application.

Under Federal law, combining pesticides is legal unless the pesticide labeling of any of the pesticides involved instructs you not to combine them. However, not all pesticides work well when mixed together. They must be compatible — that is, mixing them together must not reduce their safety or effectiveness in any way. The more pesticides you mix together, the greater the chance of undesirable effects.

Some pesticide mixtures that are physically incompatible make the mixture difficult or impossible to apply and may clog equipment, pumps, and tanks. These reactions sometimes cause the pesticide to form lumps or gels, to become solids that fall to the bottom of the mix tank, or to separate into layers that cannot be remixed.

Sometimes the combined pesticides create a chemical reaction that cannot be seen by

looking at the mixture. However, the chemical change can result in:

- loss of effectiveness against the target pests,
- increased toxicity to the pesticide handler, and
- injury to the treated surface.

Some pesticide labeling lists pesticides (and other chemicals) known to be compatible with that formulation. Compatibility charts are available in some pest management recommendations, pesticide trade publications, and Cooperative Extension or industry recommendations. If you cannot find a chart that lists the compatibility of the two pesticides (or the pesticide and other chemical) that you wish to mix, test a small amount of the mixture before you mix large quantities.

## Compatibility testing

First, put on personal protective equipment. Wear at least the equipment required by the labeling of any of the pesticides to be combined; protective eyewear; and chemical-resistant gloves and apron, both preferably made of foil laminate. Get a large, clean, clear glass container, such as a quart jar. Use the same water (or other diluent) that you will use when making up the larger mixture. Add the water and each of the products in the same proportions as you will mix them. Unless the pesticide labeling states otherwise, add pesticides to the diluent (usually water) using the "W-A-L-E" plan:

1. Add some of the diluent first.
2. Add **W**ettable and other powders and **W**ater-dispersible granules.
3. **A**gitate thoroughly and add the remaining diluent.
4. Add the **L**iquid products, such as solutions, surfactants, and flowables.

5. Add **E**mulsifiable concentrates last.

Shake the jar vigorously. Feel the sides of the jar to determine if the mixture is giving off heat. If so, the mixture may be undergoing a chemical reaction and the pesticides should not be combined. Let the mixture stand for about 15 minutes and feel again for unusual heat.

If scum forms on the surface, if the mixture clumps, or if any solids settle to the bottom (except for wettable powders), the mixture probably is not compatible. Finally, if no signs of incompatibility appear, test the mixture on a small area of the surface where it is to be applied.

## Applying Pesticides Safely

Every time you apply pesticides, you have two major responsibilities:

- protecting yourself, others, and the environment, and
- making sure that the pesticide is applied correctly.

## Personal Protective Equipment

By law, you must wear the personal protective equipment and other clothing that the pesticide labeling requires for applicators. Consider using additional protection for some types of pesticide application tasks. You may need to weigh several factors before you can make good decisions about the personal protective equipment you should wear.

## Hand-carried application equipment

When you carry the application equipment, such as hand-held sprayers or shake cans, you risk being directly exposed to the

pesticide. A dripping or partially clogged nozzle, an unfastened cap, a leaky hose, or a loose connection are extremely likely to cause exposure. Consider wearing extra personal protective equipment to protect the area of your body that is in contact with the equipment.

If the application equipment is carried in front, consider wearing a sleeved apron, an apron with built-in gloves and sleeves, or an apron plus arm-covering gloves to protect your front from leaks, drift, and splashes.

If the application equipment is a type that is carried on your back, such as backpack, knapsack, or trombone-style sprayers or dusters, consider wearing a cape to protect your back and shoulders from leaking equipment.

If you carry only the nozzle, consider wearing arm-covering gloves or elbow-length gloves with the cuffs taped or otherwise sealed to the coverall sleeve.

### **Entering the path of the released pesticide**

Many applications performed while on foot cause you to walk into the path of the pesticide you are releasing. Whenever possible, apply pesticides so that you are backing into the untreated area, away from where the pesticide is being released. Under many conditions, however, it is unsafe to walk backwards in an application site.

If you must walk into the path of the released pesticide, consider wearing shin-high or knee-high boots, or protective footwear with chemical-resistant pants. Spraying a thick coating of fabric starch or fabric stain protectant on the lower legs of your coveralls can provide a temporary barrier for low-toxicity pesticides and also makes the coveralls easier to clean.



When you apply pesticides from a vehicle, try to use equipment that releases the pesticide to the rear so that you are located in front of and above the area of release and are moving away from it. Sometimes, however, you may have to use a vehicle that causes you to drive into the path of the pesticide that is being released.

Whether you are walking or riding, if the pesticide is not directed downward or if it remains suspended in the air long enough to cause exposure to the front of your body, consider wearing an apron or chemical-resistant suit. If the pesticide mist or dust reaches

as high as your face, consider a dust/mist respirator and eye protection.

### **Walking into a just-treated area**

Even when you apply a pesticide from a vehicle, you may need to walk into an area that you have just treated. For example, you may need to repair or adjust the equipment or check the pesticide dispersal. You probably will be climbing over a contaminated rig and walking through an area that was treated only moments before. Consider putting on additional personal protective equipment while you are out of the vehicle.



If the vegetation in the treated area is covered with pesticide spray or dust and is fairly short, consider shin-high or knee-high boots, or protective footwear with chemical-resistant pants. In this situation, as with walking into the path of the released pesticide, it may be useful to apply spray starch or fabric stain protector to the pants legs.

If the plants in the treated area are tall, consider wearing a chemical-resistant suit in addition to the footwear. If you cannot wear a chemical-resistant suit because of the heat, try a cape or an apron.

If spray is dripping or dust is falling from overhead, consider a hood or wide-brimmed hat in addition to the body protection and footwear. A dust/mist respirator and protective eyewear may be necessary, too.

### High-exposure applications

Certain types of pesticide applications pose a special exposure risk, because they engulf you in pesticide fallout. They include:

- mist blower or airblast applications,
- aerosol and fog applications, especially indoors,

- some applications using high-pressure sprayers and power dusters,
- applications directed upward over your head, such as to tree canopies or roof eaves,
- aerial applications that use human flaggers to mark the swath.

Whenever you work in these situations, large amounts of pesticide fallout are likely to be deposited on your skin and clothing, often to the point of completely drenching or covering you. Unless you are in an enclosed cab, you cannot avoid this exposure, even if you perform the application in conditions of little or no air currents.

In these situations, you should wear more personal protective equipment than the pesticide labeling requires for other types of applications. Only a chemical-resistant suit with a hood, gloves and footwear with sealed cuffs, and a full-face respirator or half-face respirator with sealed goggles can provide enough protection for these high-exposure applications.

### Applications in enclosed spaces

Pesticides sometimes are applied in enclosed spaces such as warehouses, factories, homes, and other buildings; railcar, ship, and truck cargo areas; silos, elevators, and other grain storage areas; and greenhouses. When you use pesticides in enclosed spaces, you increase the risk of being exposed to the pesticide by inhalation. You may need to use a respirator even if you would not need one for the same application outdoors.

### Adjusting pesticide-coated equipment

You may need to wear a protective apron while doing some types of equipment adjustments and repairs. Consider wearing a

vapor-removing respirator, even outdoors, if you must adjust fumigation equipment.

### **Immersing hands and forearms**

Some application techniques, such as animal, plant, or seed dipping vats and spray-dip machines, require you to place your hands and forearms into the pesticide liquid or dust. With this exposure, consider a sleeved apron for full front and arm protection, and protective footwear. A face shield will protect against splashes or drifting dusts.

### **Applying in air currents**

If you will be applying pesticides into or across wind or air currents, consider wearing extra personal protective equipment, because pesticide may be blown onto you. More body protection, protective eyewear, and a dust/mist filtering respirator may be appropriate.

### **Applying concentrates**

You may be exposed to highly concentrated pesticides during some applications. Ultra-low-volume concentrates and fumigant formulations may be close to 100-percent active ingredient and often are highly toxic. Consider using extra personal protective equipment when applying concentrates, such as that required for mixing and loading of those formulations.

## **Application Procedures**

Every time you apply a pesticide, follow these basic procedures to make sure that you are using the pesticide safely and effectively:

### **Deliver the pesticide to the target**

Take the time to be sure that the pesticide is reaching the surface or

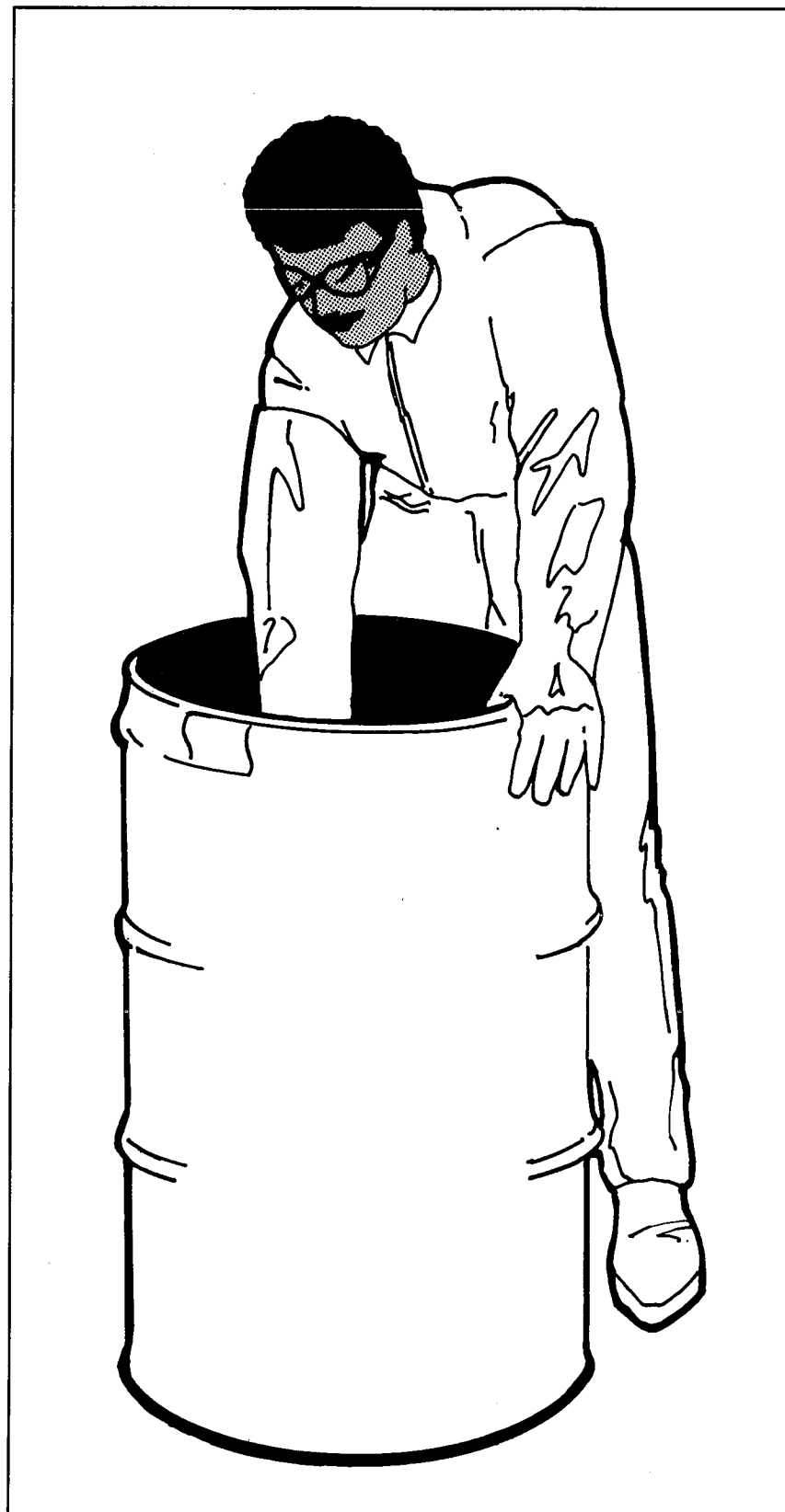

space to which you are directing it. Pesticide that is deposited elsewhere is a waste of time and money and may harm the nontarget areas.

### **Check the delivery rate**

Check to be sure that you are applying the pesticide evenly and in approximately the right amounts. No puddles of liquid

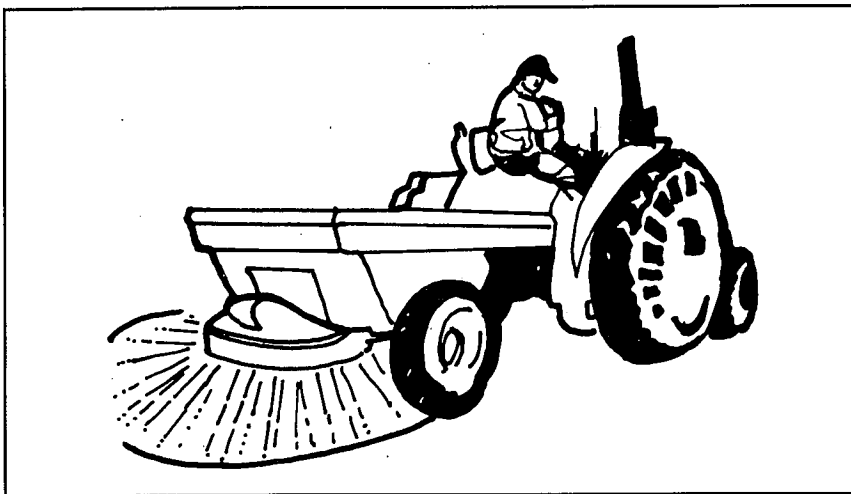

pesticide or mounds of dry pesticide should be deposited in the application area. Be especially careful in areas where you turn or pause. Many types of application equipment will continue to release pesticide even when not in motion.

When you have applied the pesticide to the first part of the area or space that is to be treated, check to be sure that approximately the correct proportion of pesticide has been used. If too little is being released, check the equipment openings for clogging or obstructions. If too much is being released, check for worn or stuck openings.

### **Check for appearance**

As you apply, notice whether the pesticide you are releasing looks the way it should. Applications of wettable powders usually have a whitish color. If the liquid is clear, check to be sure that you are agitating the mixture enough to keep the wettable powder mixed with the water. Granules and dusts should appear dry and should not form clumps. Emulsifiable concentrates usually look milky. If the pesticide does not look right, be sure that you have the right mixture and that it is still blended evenly.

Check the appearance of the target area where you have just

released the pesticide. If the surface is changing colors or is stained unexpectedly, stop and check whether you are harming the surface.

### **Avoid nontarget organisms**

Before you apply a pesticide, clear all unprotected people from the area. It is illegal to allow them to be exposed to a pesticide application — either directly or through drift. Also remove any pets or livestock that are not being treated with the pesticide. Even when the pesticide application is a narrowly directed one, such as a crack and crevice treatment, keep people and animals out of the immediate area during the application.

Check the pesticide labeling to find out when people and nontarget animals can go back into the application area. The labeling of some pesticides restricts entry into treated areas for periods ranging from several hours to several days. Even if the pesticide labeling has no such instructions, do not allow anyone to enter the treated area at least until any dusts and mists have settled out of the air and any vapors have dispersed. After indoor treatments, consider ventilating the area with fans, vents, or open windows before you let anyone return. Whenever

possible, encourage people to remain out of the treatment area for at least an hour after application.

### **Avoid nontarget surfaces**

When possible, remove from the application site any items that should not be contaminated with pesticides. Cover or protect any items that cannot be removed from the area and that are not involved in the handling activity. Items that should be removed or covered include such things as food and food utensils; bedding; toys; seed; pet or livestock feed, water, or supplies; and other items that could transfer pesticides to people, pets, or livestock.

### **Operate equipment safely**

Turn off your equipment whenever you pause for any reason. Take special care to turn it off before making any adjustments or repairs. When you stop application to take a break, to move to another site, or for repairs, depressurize any pressurized tanks. Turn off the main pressure valve on the tank and release any pressure remaining at the nozzles.

If you are applying pesticides at a distance from your equipment — at the end of a long hose, for example — be sure that unprotected people and pets stay away from the equipment. You may need to post a helper near it.

Check hoses, valves, nozzles, hoppers, and other equipment parts occasionally while you are applying. If you notice a problem, stop right away and fix it. Do not use bare hands or your mouth to clear nozzles, hoses, or hopper openings. Carry a small nylon brush for such jobs. Be sure that any tool used for this kind of job is never used for any other purpose.

## After Mixing, Loading, and Application

As soon as you finish mixing, loading, or applying a pesticide, you should do a few important followup tasks. Take the time to clean up properly. Wash your pesticide equipment and then wash yourself. Return equipment to its designated place and safely store or dispose of all pesticide materials and other chemicals that you have used. Be sure that your work site presents no hazards to people or to the environment. Never leave the site unattended until everything has been cleaned up and put away. While you can still remember the facts, make a record of what you have applied and the conditions at the application site.

### Equipment Cleaning

Always clean mixing, loading, and application equipment as soon as you finish using it — do not leave equipment with pesticides on or in it at the mixing and loading site or at the application site. When the job is completed and the tank or hopper is empty, return the equipment to the designated equipment cleanup area. Avoid washing equipment repeatedly in the same location unless you use a containment pad or tray. Over time, the flooring or soil in a frequently used area can become contaminated with large amounts of pesticides. This contamination increases the likelihood of harmful effects to people and animals who may contact the contaminated area and increases the likelihood of runoff or leaching into water systems. Also avoid keeping pesticide-contaminated equipment in one location all the time. Pesticides may move off the outside of the

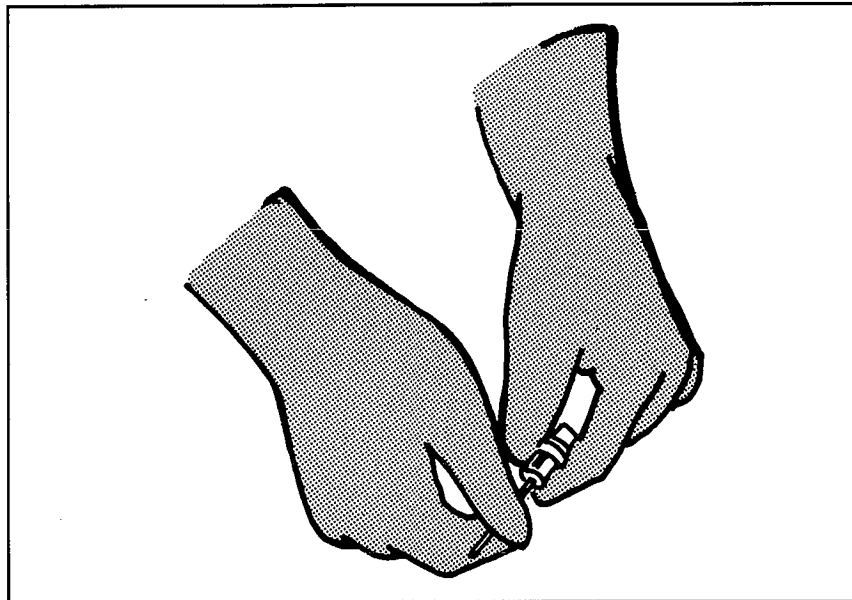

equipment and onto the floor or soil.

Do not assign a worker to clean pesticide-contaminated equipment unless that person has been instructed in the basic rules of pesticide safety. Remember that equipment cleaning presents as great a risk of exposure to pesticides as do many other pesticide handling tasks and that all parts of the equipment are likely to have pesticides or pesticide residues on them. When you clean pesticide-contaminated equipment, wear the personal protective equipment that the labeling requires for handling jobs, plus a chemical-resistant apron.

### Benefits of correct cleaning

Sloppy cleanup practices are one of the main causes of equipment failure or malfunction. Never keep excess pesticides in your equipment for more than a short time. Even small amounts of pesticide residues that are left in equipment can damage it.

Liquid pesticides that are left in the equipment may quickly corrode the equipment and clog or corrode the nozzle openings. They may cause the equipment to leak or cause the nozzles to release too

little or too much pesticide when the equipment is operated. Some liquid pesticides change if they are stored after being diluted and will not be suitable for application at a later time. Some will settle out and form a solid clump at the bottom of the tank that even mechanical agitation cannot remix. Others will separate into two or more separate liquids that cannot easily be remixed. Liquid pesticides that are allowed to stay in the equipment until they are totally dry may be impossible to remove completely at a later time.

Dry pesticides that become wet through humidity, rain, dew, or other moisture tend to clump and stick to the sides and hopper openings. They cannot be applied at a later time, and they cannot be easily removed from the equipment.

### Cleaning procedures

After the equipment is empty, clean both the inside and outside thoroughly, including nozzles or hopper openings. Sometimes you may need to use the diluent used in the pesticide mixture (kerosene or high-grade oil), special cleaning agents, or water under pressure. In

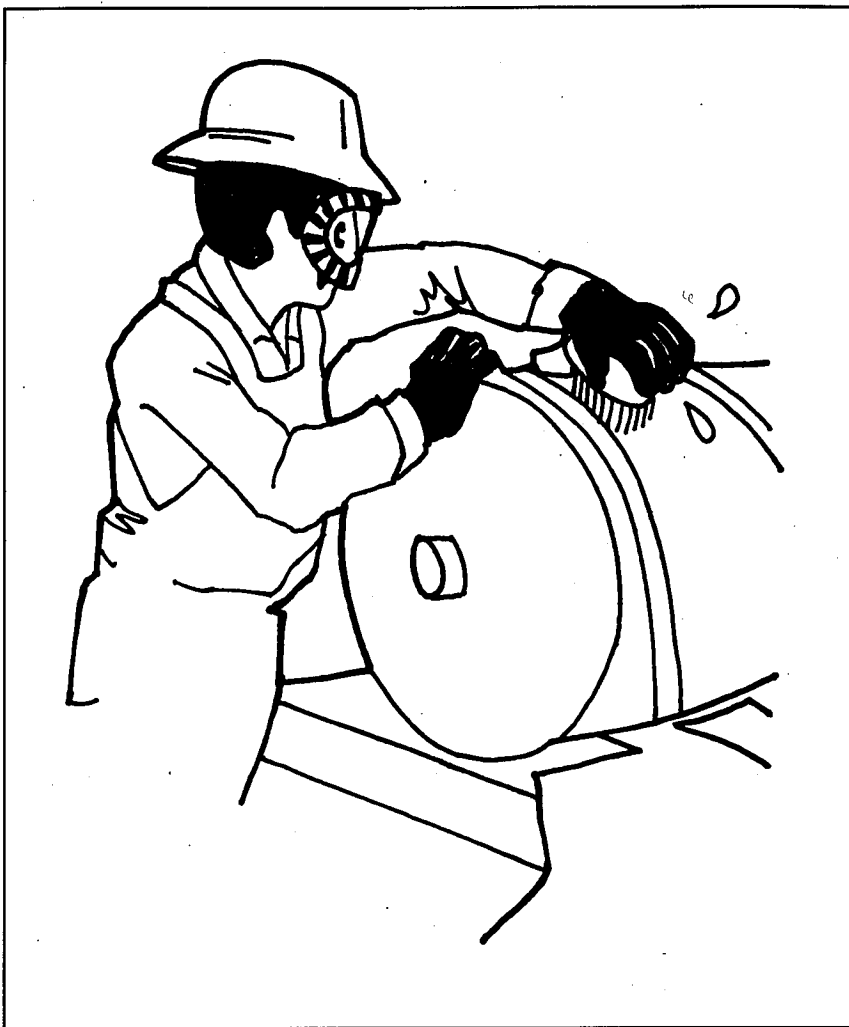

other cases, ordinary water may be enough.

Collect the rinsate — the liquid that results from the washing process. If you do not have a way to reuse or dispose of the rinsate, limit the amount of material you use, so you will create less waste.

Wash with special care any vehicles, such as vans and trucks, that may be used for transporting unprotected workers or for family use. People have been poisoned by riding in vehicles that had been used to apply pesticides or to perform flagging for aerial applications.

### Rinsates

Remember that the rinsates you create when you clean your equipment contain pesticides and

can be harmful to people and the environment. Do not allow rinsates to flow into water systems, including sink or floor drains, rainwater culverts, wells, streams, lakes, and rivers. Do not create puddles that children, other unprotected persons, or animals could get into.

You may use equipment rinsate as a diluent for future mixtures of pesticides, if:

- the pesticide in the rinsate is labeled for use on the target site where the new mixture is to be applied,
- the amount of pesticide in the rinsate plus the amount of pesticide product in the mixture does not exceed the labeling rate for the target site,

- the rinsate is used to dilute a mixture containing the same pesticide or a compatible pesticide,

- you comply with other application instructions specified on the labeling, including any specific labeling instructions for application as an excess pesticide.

The rinsate **cannot** be added to a pesticide mixture if:

- the pesticide labeling does not list the rinsate as an acceptable diluent; for example, if the rinsate contains a strongly acidic or alkaline neutralizing agent,
- the rinsate contains strong cleaning agents, such as bleach or ammonia, that might harm the plant, animal, or surface to which the pesticide will be applied,
- the rinsate would alter the pesticide mixture and make it unusable; for example, if the pesticides are physically or chemically incompatible.

If you have any rinsates that you cannot use, dispose of them as you would excess pesticides.

### Pesticide labeling instructions

Typical pesticide labeling statements that alert you to these concerns include:

*Do not store spray solution in tank overnight.*

*Clean application equipment thoroughly after use by flushing with water in a safe place.*

*Do not contaminate water by cleaning of equipment.*

*Flush all application equipment with fuel oil, kerosene or a similar type of petroleum solvent immediately after use. Fill pumps and meters with new motor oil or a 50% motor oil/fuel oil mixture before storing. Do not use water. Dispose of rinsate by incorpora-*

tion into area just treated or by other approved means.

## Personal Cleanup

When you finish working with pesticides or pesticide-contaminated equipment, take time for personal cleanup. Wash the outside of your gloves first, before taking them off. Then carefully peel back your personal protective equipment to avoid getting pesticides on your skin. Remove any other clothing that has pesticide on it.

If you cannot take a shower right away, use a mild liquid detergent and warm water to wash your face, hands, forearms, and any other area that may have pesticides on it. As soon as you can — no later than the end of the work day — wash your whole body and hair thoroughly with a mild liquid detergent and plenty of warm water.

When you remove your personal protective equipment and work clothing, put it in a plastic box or bag until it can be laundered. Do not allow children or pets to play with these items. Do not wash work clothing and personal protective equipment in the same wash water with the family laundry.

## Recordkeeping

Keeping records of pesticide use and application is a good idea. Records can establish proof of proper use. If an error has been made, records are helpful in finding the cause. They also can provide you with information to use in response to claims of excess residues or damages.

Good records can save you money. They allow you to compare the results obtained from using different pesticides, different formulations, and different equipment, and from applying

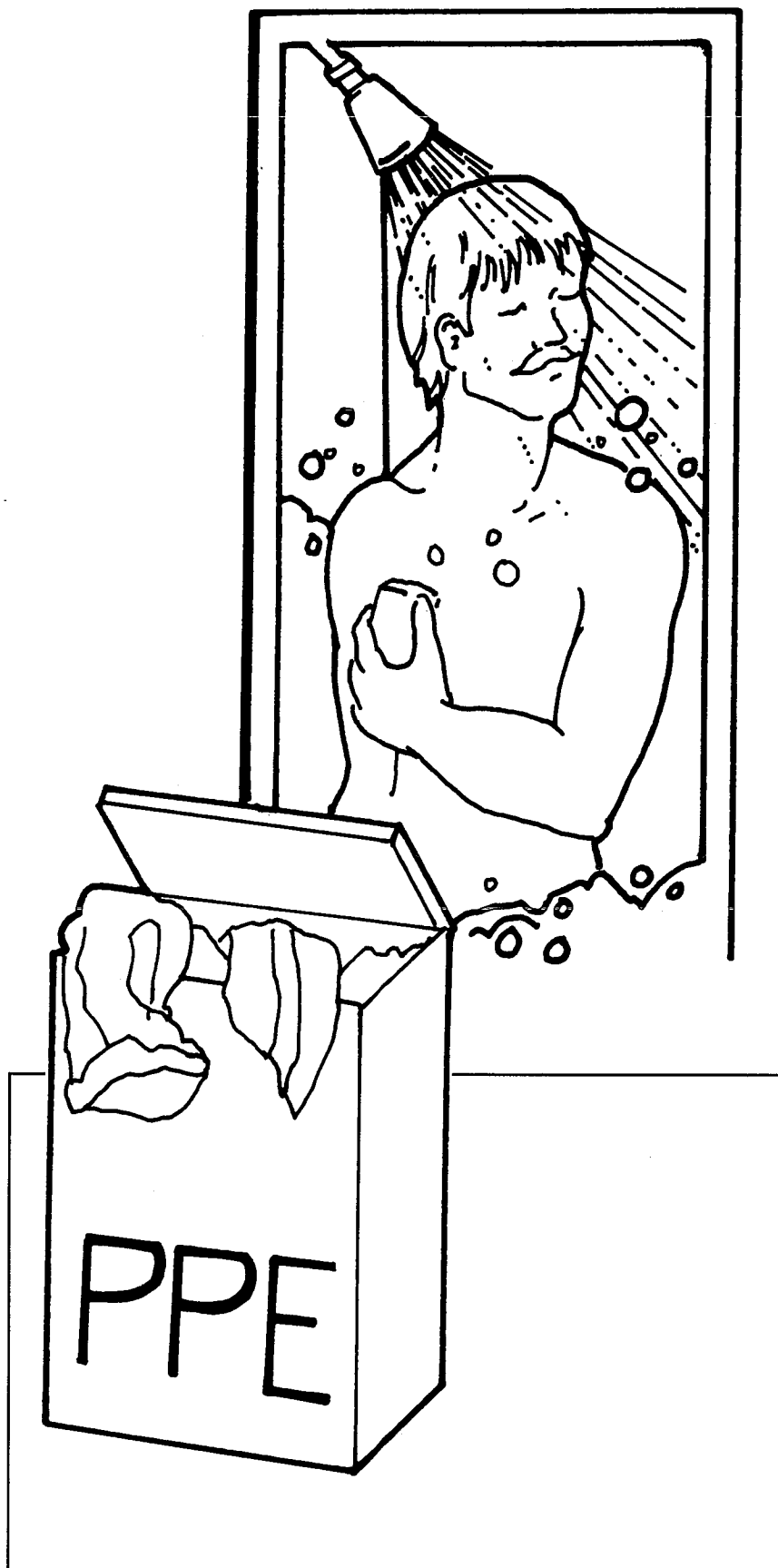



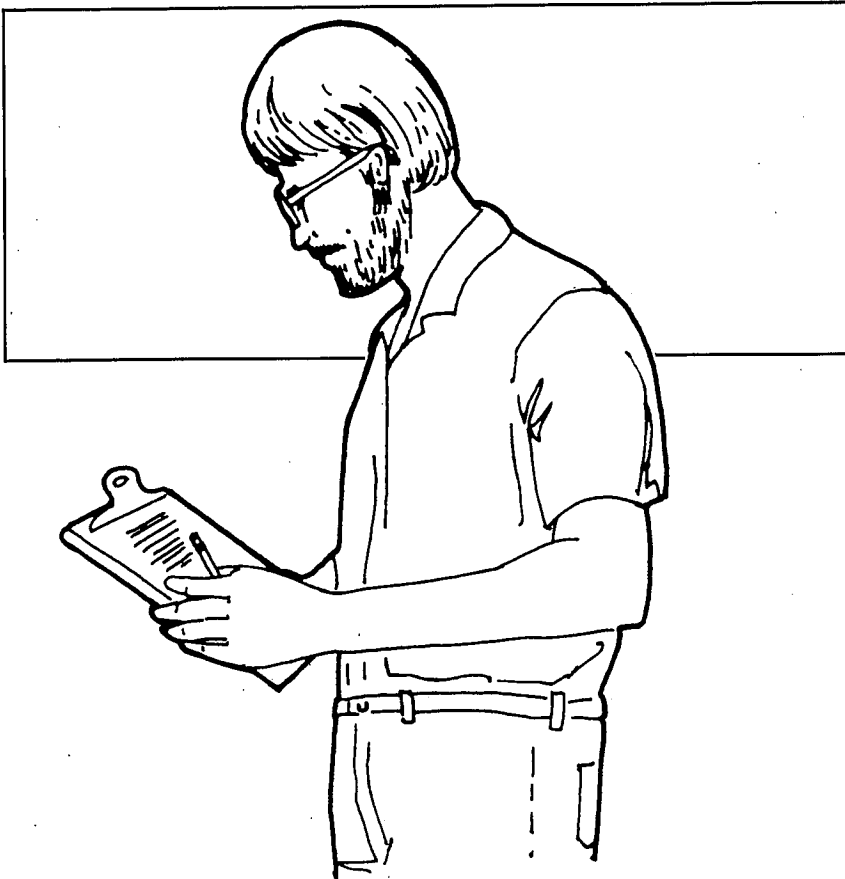

under various site conditions. You can improve your pest-control practices and your efficiency.

Records can help you reduce pesticide mistakes or misuse. If a pest is not controlled, if damage has occurred in the target area, or if a pesticide has moved off the target area and caused problems, you may be able to determine what went wrong. Records may help you to determine that a particular pesticide, a particular formulation, a type of application equipment, or some condition in the treatment area caused the problem. Then you can take steps to avoid such a situation in future pesticide applications.

Good records can help you reduce carryover by buying only the amount of pesticides you will need. Some pesticides do not store well for long periods of time, and disposal of excess pesticide can be very expensive.

### **Necessary information**

The more information you keep on record, the more useful the records will be. Devise a standard form to be sure you write down all the necessary facts each time. Keep the forms handy so you will fill them out promptly — you may not remember all the information at a later date.

Record:

- Names of any handlers involved in the activity,
- Time of day and date of application,
- Location and description of treated area, including climatic conditions at the site,
- Treated surface (plant, animal, soil, water, structure, or other surface at which the pesticide was directed,
- Target pest,
- Equipment used,
- Pesticide used — brand name, common name, formulation type,

- percentage of active ingredient, and EPA registration number,
- Amount of formulation used (and amount of diluent or other adjuvants added, if any),
- Total amount of pesticide applied and the rate of application (pounds per acre, ounces per 100 square feet, etc.), if applicable,
- Size of treated area (total square feet, acres, or linear feet; room or structure size; number of animals, etc.).

### **Additional information**

Every record form should have a space for additional comments. Use this space to jot down information for your own personal use or to record anything that was unique about the treatment. Record information about scouting or monitoring that may have been done. Write down what other pest management methods are being used and how successful the overall pest management strategy is. You can use this information to improve your pest management operations, either through better customer or worker relations or by saving money.

### **Required records**

Many States, tribes, and other local authorities require you to keep records of pesticide applications. Be sure you know what records you must keep and how long you must keep them. Many enforcement inspections look closely at recordkeeping, because records are a clue to the way an operation is being managed. Keep your records in a safe place where you can find them when you need them.

## Safety Systems

Closed mixing and loading systems, enclosed application systems, and pesticide containment systems are excellent investments for pesticide handlers who handle large quantities of pesticides or who handle pesticides that are very hazardous to humans or to the environment. In some cases these systems may be required for handling certain pesticides or when pesticides are used in or near sensitive areas.

### Closed Mixing and Loading Systems

A closed mixing and loading system is a system designed to prevent pesticide from coming in contact with handlers or other persons during mixing and loading. The labeling of some pesticides requires you to use a closed mixing and loading system when handling the product. This requirement usually appears on products that have a high risk of causing acute effects or that may cause delayed effects. Typical statements on the labeling of such products include:

*Must be transferred and mixed using closed-system equipment. Do not use open mixing vats or tanks, or open pouring.*

*Must be transferred into the spray tank through the use of a mechanical transferring device.*

Some States may require use of closed mixing and loading systems for pesticides with high acute toxicity.

There are two primary types of closed mixing and loading systems. One type uses mechanical devices to deliver the pesticide from the container to the equip-

ment; the other type uses soluble packaging.

### Mechanical systems

Mechanical systems are often a series of interconnected equipment that allows you to remove a pesticide from its original container, rinse the empty container, and transfer the pesticide and rinse solution to the application equipment without being exposed to the pesticide. The most common mechanical closed systems are for use only with liquid formulations.

Closed mixing and loading systems are often custom-made, using components from several commercial sources. Because pesticide container openings, shapes, and sizes vary, no single closed system can be used with all containers. The mechanical systems now available remove the pesticide concentrate from the original container in one of two ways — by gravity or by suction.

**Gravity systems** are sometimes called “punch and drain” systems. The unopened pesticide container is inserted into a chamber, which is then sealed. A punch cuts a large opening in the container, allowing all the material to drain into the mixing tank. A water nozzle attached to the punch sprays the inside of the container

to rinse it thoroughly. The rinse water also drains into the mixing tank. The rinsed container is then removed for disposal.

A limitation of this system is that only full container quantities can be used. It is not possible to use part of the pesticide in a container and store the rest.

Gravity systems are available for use with both liquid and dry concentrates.

**Suction systems** use a pump to remove the pesticide through a probe inserted into the container. Some containers are equipped with built-in probes. The pesticide is transferred to the mixing tank by hose and pipe. When the container is empty, it and the transfer system are rinsed with water. The rinse water is added to the mixing tank.

To allow the use of only part of the pesticide in the container, the system must have a way to measure the amount of pesticide suctioned into the mixing tank and must allow the probe to remain in the container until all the pesticide is used and the container and probe can be rinsed. Some probes have a breakaway head that allows the head to stay and the probe to be withdrawn and reused.

Some suction systems do not permit the resealing of partially

### Advantages and Disadvantages of Closed Systems

#### Advantages:

- increased handler safety,
- less need for personal protective equipment,
- reduction of spills,
- more accurate measurement, which reduces overdosing and underdosing and may save you money.

#### Disadvantages:

- some systems are expensive or scarce,
- some systems are cumbersome,
- some systems are not appropriate for many pesticides and many handling activities.

emptied containers. Another disadvantage of suction systems is that highly viscous pesticides (those that pour like molasses) are difficult to move by suction.

### **Soluble packaging**

Soluble bags or containers are a much less complex type of closed-system mixing and loading. The pesticide package is designed to be placed, unopened, into the mixing tank. The container dissolves in the solvent (usually water) in the tank.

Disadvantages of soluble packaging include the risk of accidentally releasing the concentrate if the packaging is exposed to water or other solvents during shipping or storage, and the high risk of splashing as containers are added to the tank.

### **Personal protective equipment requirements**

The personal protective equipment requirements for many pesticides may be reduced if you use a closed system:

- You may be allowed to substitute a long-sleeved shirt, long-legged pants, shoes, and socks for the personal protective equipment listed on the pesticide labeling.
- If the closed system is for the mixing or loading of concentrated pesticides, you may be required to wear a chemical-resistant apron and chemical-resistant gloves.
- If the system operates under pressure, you may be required to wear protective eyewear.

If you wear less personal protective equipment while using a closed system, you should keep at the mixing and loading site a set of the personal protective equipment that the pesticide labeling requires for regular mixing and loading activities. Then you will be prepared in case the closed

system equipment breaks down or there is an accidental spill.

### **Enclosed Application Systems**

You can reduce your exposure to pesticides by using enclosed systems to do some applications. An enclosed application system is an enclosure, such as a cab or cockpit, that surrounds the occupants and prevents them from coming in contact with pesticides outside of the enclosure.

When you will be working in an enclosed application system, pesticide labeling directions and current pesticide regulations may allow you to wear less personal protective equipment than is required for ordinary application. However, you must keep the required personal protective equipment inside the cab and wear it any time you get out of the cab in the treated area. Remove it before you get back into the cab. Either store the contaminated personal protective equipment outside the cab or place it in a chemical-resistant container, such as a plastic canister or trash bag, that can be closed tightly and taken inside the cab.

Enclosed systems for application include:

- enclosed cab — provides skin and eye protection,
- enclosed cab with an air-filtering ventilation system — protects against inhalation of dusts and mists, and protects skin and eyes,
- enclosed cab with a vapor-removing ventilation system — provides inhalation protection plus skin and eye protection,
- enclosed cockpit — provides skin, eye, and inhalation protection.

### **Pesticide Containment Systems**

If you often mix and load pesticides in one place, or if you often clean equipment at one location, you may find a pesticide collection pad or tray a good investment. These pads and trays are designed to catch spills, leaks, overflows, and wash water and allow them to be recovered for reuse or disposal. Larger pads may be permanently installed, but smaller pads and trays can be portable.

These systems can save you time and money. They make spill cleanup easier, and they reduce pesticide waste by allowing you to reuse the rinse water and spill cleanup water. They also help prevent the harm that spills and runoff can cause to the environment or to people.

### **Collection trays**

A collection tray can be used at mixing, loading, and equipment cleaning sites where only small amounts of pesticide are handled at a time and portable equipment is used. Such tasks often take place on a counter or bench. The tray can be made of sturdy chemical-resistant rubber or plastic, such as a boot or shoe mat. The tray must have a rim around it to collect spills and leaks and should have a spout where the contents can be poured off.

### **Collection pads**

A collection pad is suitable for mixing, loading, and equipment cleaning sites where large quantities of pesticides are handled and large equipment is cleaned. Such operations often take place outdoors or in a large, open space in a building such as a warehouse or barn.

The collection pad should be made of a waterproof material, such as sealed, smooth concrete; glazed ceramic tile; or no-wax sheet flooring. Porous surfaces, such as wood, asphalt, soil, or carpeting, are not acceptable. The pad must be concave or must have

curbs or walls high enough to hold the largest amount of spill, leak, or equipment wash water likely to be created at the site. It also must be equipped with a system for removing and recovering spilled, leaked, or released material — either an automatic sump system or a manually operated pump.

Locate the collection pad where rainwater, irrigation water, and flood water cannot flow over it. Wash the pad at the end of each day's use to prevent possible harm to the environment and to animals and unprotected people.

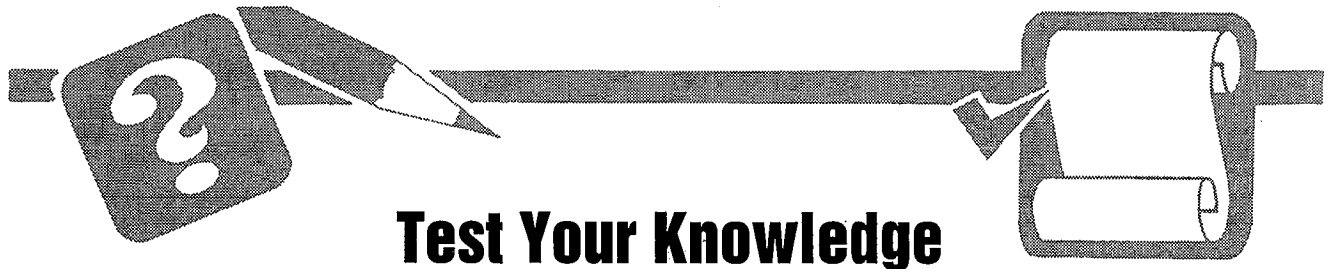

## Test Your Knowledge

**Q.** What two precautions should you take to avoid getting pesticides into your water source at a mix-load site?

**A.** 1. Keep the water pipe or hose well above the level of the pesticide mixture, and use a device to prevent back-siphoning, if necessary.  
2. Avoid mixing or loading pesticides in areas where a spill, leak, or overflow could allow pesticides to get into water systems.

**Q.** What four types of personal protection, beyond what you need during application, should you consider wearing while mixing or loading pesticides?

**A.** Front protection, face protection, protection from dusts, and protection from vapors.

**Q.** What should you do with an empty pesticide container?

**A.** 1. If containers are rinsable, rinse them as soon as they are empty.

2. Return all empty pesticide containers to the pesticide storage area or the container holding area when you finish your task.  
3. Crush, break, or puncture empty containers that cannot be refilled, reconditioned, recycled, or returned to the manufacturer.  
4. Dispose of containers in accordance with labeling directions and with any laws or regulations that apply.

**Q.** What types of empty pesticide containers can be rinsed?

**A.** 1. Glass, metal, and plastic containers,  
2. Plastic-lined paper or cardboard containers, and  
3. Unlined paper or cardboard containers that can withstand the rinsing process.

**Q.** What two methods of rinsing can you use?

**A.** Triple rinsing and pressure rinsing.

**Q.** What are three ways to help you decide whether you can safely mix two pesticides together for application?

**A.** 1. Check the pesticide labeling. It may list the pesticides (and other chemicals) known to be compatible with the formulation.  
2. Get a compatibility chart, which may be available from several sources.  
3. Test a small amount of the mixture before mixing large quantities of the pesticides together.

**Q.** Name four types of pesticide application that might require more personal protective equipment than that specified on the pesticide labeling.

**A.** 1. Hand-carrying application equipment.  
2. Entering the path of the released pesticide.  
3. Walking into a just-treated area.  
4. Using high-exposure application methods where the pesticide may engulf you.

5. Applying pesticides in enclosed spaces.

6. Adjusting pesticide application equipment.

7. Immersing hands and forearms in pesticides.

8. Applying into or across air currents.

9. Applying concentrated pesticides.

**Q.** What safety procedures should you follow each time you apply a pesticide?

**A.** 1. Deliver the pesticide to the target site.

2. Check the delivery rate.

3. Check for appearance.

4. Avoid nontarget organisms.

5. Avoid nontarget surfaces.

6. Operate equipment safely.

**Q.** When you are finished with a mixing, loading, or application task, what should you do right away?

**A.** 1. Wash your pesticide equipment and then wash yourself.

2. Return equipment to its designated place,

3. Safely store or dispose of all pesticide materials and other chemicals that you have used.

4. Be sure that your work site presents no hazards to people or to the environment.

5. Make a record of what you have applied and the conditions at the application site.

**Q.** What should you do with rinsate that you create when you clean your pesticide equipment?

**A.** Collect the rinsate. Reuse it, if possible, or dispose of it as excess pesticide.

**Q.** When you are finished with pesticide handling tasks, what steps should you take for personal cleanup?

**A.** Wash the outside of your gloves first, before taking them off. Then carefully peel back your personal protective equipment to avoid getting pesticides on your skin. Remove any other clothing that has pesticide on it. If you cannot take a shower right away, use a mild liquid detergent and warm water to wash your face, hands, forearms, and any other area that may have pesticides on it. As soon as you can — no later than the end of the work day — wash your whole body and hair thoroughly with a mild liquid detergent and plenty of warm water.

**Q.** Why should you keep records of pesticide applications?

**A.** 1. Records can establish proof of proper use.

2. Good records can save you money by improving your pest-control practices and your efficiency.

3. Records can help you reduce pesticide mistakes or misuse.

4. Good records can help you reduce carryover by buying only the amount of pesticides you will need.

**Q.** What are closed mixing and loading systems?

**A.** Systems designed to prevent pesticide from coming in contact with handlers or other persons during mixing and loading.

**Q.** What are enclosed application systems?

**A.** An enclosure, such as a cab or cockpit, that surrounds the occupants and prevents them from coming in contact with pesticides outside of the enclosure.

**Q.** When should you consider installing a pesticide containment system?

**A.** If you often mix and load pesticides in one place, or if you often clean equipment at one location.

**Q.** What are the advantages of pesticide containment systems?

**A.** They can save time and money. They make spill cleanup easier, and they reduce pesticide waste by allowing reuse of rinse water and spill cleanup water. They also help prevent the harm that spills and runoff can cause to the environment or to people.



# Applying the Correct Amount

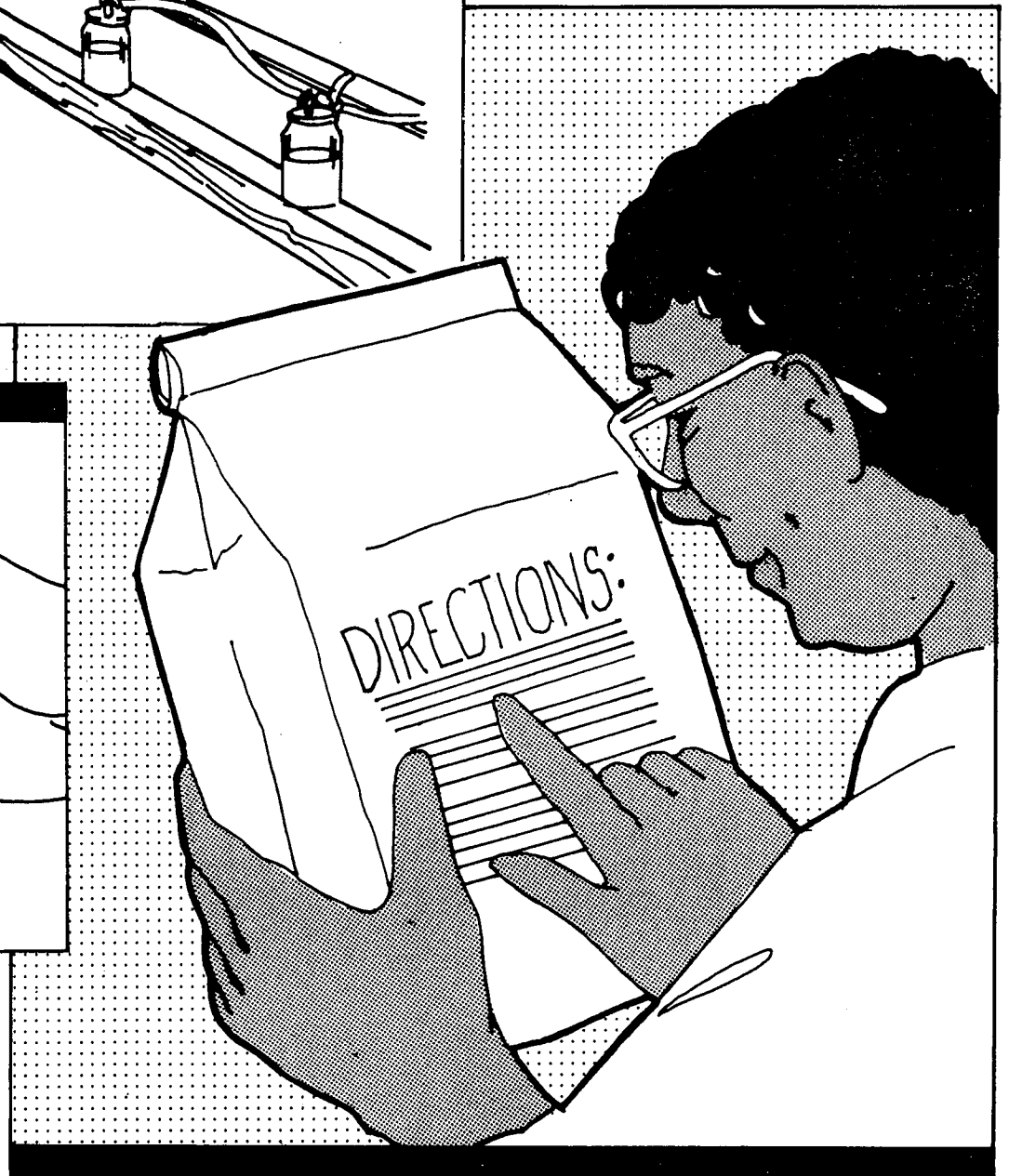
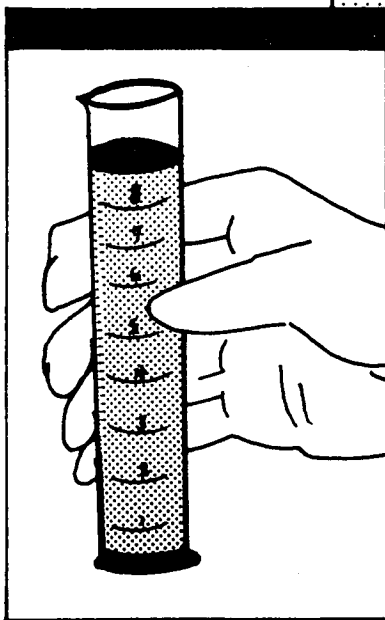
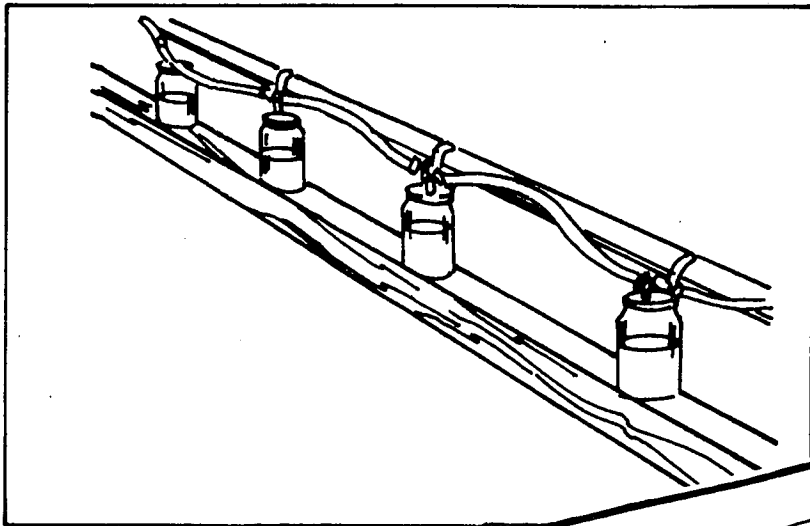

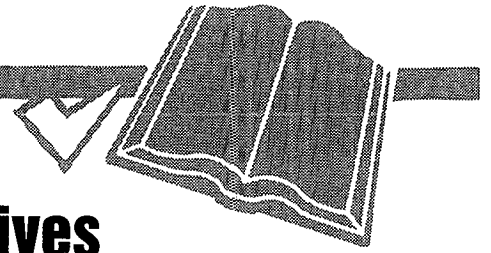
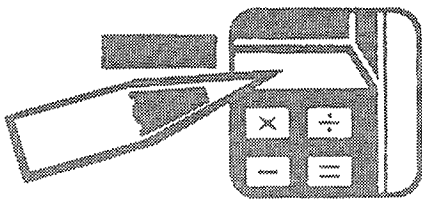

## Learning Objectives

After you complete your study of this unit, you should be able to:

- Explain why it is important to apply the correct amount of pesticide.
- Describe how to determine how much pesticide to apply.
- Identify ways that application rate is expressed.

- Explain why it is important to calibrate some equipment.
- Describe how to figure application rate.
- Explain the importance of checking calibration often.
- Explain which types of pesticides must be diluted before application.

- Explain what information you must find in the pesticide labeling or in other recommendations before you can dilute the pesticide correctly.
- Explain what information you must know about your own situation before you can calculate how much of the dilute pesticide mixture to prepare.

## Terms To Know

**Active ingredients**— The chemicals in a pesticide product that control the target pest.

**Adjuvant**— Chemical added to a pesticide formulation or tank mix to increase its effectiveness or safety.

**Concentrated**— Having a high percentage of active ingredient.

**Diluent**— Anything used to dilute a pesticide.

**Dilute**— To make less concentrated.

**Formulation**— Pesticide product as sold, usually a mixture of active and inert ingredients.

**Fumigant**— Pesticide that is a vapor or gas or forms a vapor or gas when applied and whose pesticidal action occurs in the gaseous state.

**Labeling**— The pesticide product label and other accompanying materials that contain directions that pesticide users are legally required to follow.

**Target site**— The site toward which control measures are being directed.

**Tip-and-pour**— Built-in measuring device that fills with a given amount of pesticide when the container is tilted.



**O**ne of the most important tasks for a pesticide applicator is making sure that the correct amount of pesticide is being applied to the target site. Studies indicate that only one out of four pesticide applications is applied within an acceptable range of the intended rate. Applying either too little or too much pesticide can cause problems.

**For each pesticide application, take the time to determine how much you need to apply. Then be sure that you apply the correct amount.**

**Underdosing is expensive.** If you apply too little pesticide, you may not fully control the pest. Sometimes you can repeat the entire application, but that can be very costly in both time and money. In other cases, a repeat application may not be possible, because it would result in an overdose.

**Overdosing is expensive** because of the high cost of pesticides. Do not use any more than the amounts listed in the "Directions for Use" section of the pesticide labeling. Using more product than the labeling recommends will not do a better job of controlling pests, and it is illegal. Overdosing may cause damage or

injuries, leave illegal residues, and cause you to be fined or to be liable for damages.

## Deciding How Much To Apply

Study the "Directions for Use" section of the pesticide labeling to find out how much pesticide you should apply. If the labeling lists a range of possible amounts, use the least amount of pesticide that will achieve good control of the pest. Sometimes consultants, industry

organizations, pest or pesticide specialists, Cooperative Extension agents, university specialists, or pesticide dealers provide recommendations on the appropriate amount to use.

The amount of pesticide to use is expressed in various ways. Application rates may be expressed in terms of how much **pesticide formulation** should be applied. The instructions may tell you how much pesticide formulation should be applied to each unit of area or volume in the target site

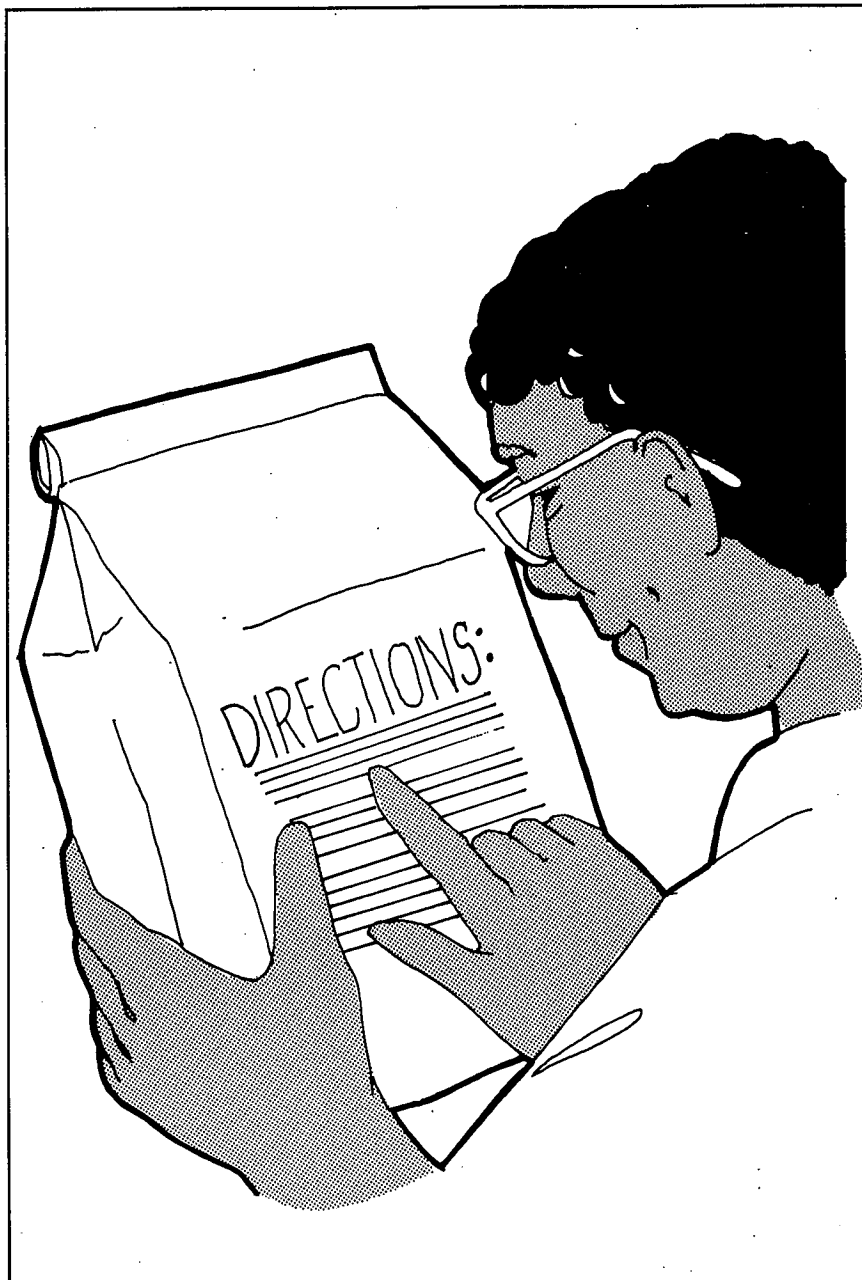

— 5 gallons of formulation per acre, or 1 pound of formulation per 100 cubic feet of space, for example. Application rates also may be expressed in terms of how much pesticide formulation should be used per volume of mixture. Labeling might call for 3 tablespoons of product per 5 gallons of water or 1 pint of product per 100 gallons of water.

Sometimes pesticide labeling and other sources express application rates in terms of how much **active ingredient** should be applied per unit of area or per volume of mixture — 1 pint active ingredient per 1,000 square feet, or 1/2 pound active ingredient per 500 gallons of water, for example. When the application rate is expressed in this way, you can select different formulations and be able to figure how much to dilute each one. However, figuring the correct dilution for active ingredient recommendations is more complicated.

Occasionally the application rate is expressed in terms of a **percentage of the final dilution** — 1/2 percent by volume or 1 percent by weight, for example. Products that are adjuvants often express the application rate in this way. Expressing application rate as a percentage allows the user to calculate the dilution correctly for whatever dilution method is being used for the formulation.

## Mixing, Loading, and Calibration Alternatives

Knowing what amount of the pesticide you must apply is only the first step. Next, you must determine how you will deliver the correct amount to the target site. Depending on the type of formulation you choose and the type of application equipment you

will use, you may have to do some combination of three basic tasks — mixing the pesticide, loading it into your equipment, and calibrating the equipment so you will know exactly how much pesticide it is delivering.

■ **Mixing** — Unless the pesticide is a ready-to-use formulation or is designed to be applied full strength, you must carefully combine the right amounts of concentrated pesticide formulation and diluent to make the needed application-strength pesticide mixture.

■ **Loading** — You may need to transfer the pesticide into the equipment before it can be applied.

■ **Calibrating** — For many kinds of applications, you must measure and adjust the amount of pesticide your equipment will apply to the target site.

Each different combination of formulation and equipment type requires you to do a different combination of these tasks to prepare for applying a measured amount of pesticide.

## No Calibration, Mixing, or Loading Needed

Some pesticide formulations are sold at application strength and are already in the equipment needed for application. These include aerosol cans; squeeze-trigger sprayers; delayed-trigger foggers; baits; shaker-can dusters; impregnated collars, bars, strips, and rollers; and wiper bags. The pesticide is applied to the point of runoff, is directed at a specific target, is placed so the target contacts it, or is released to fill an enclosed space. Most of these pesticides are available for use in only a few specialized pest control situations.

## Loading Needed, No Mixing or Calibration

Some ready-to-use pesticides are not sold in the pesticide application equipment. The user must load them into the equipment. If the application equipment to be used is a squeeze-trigger sprayer, shaker-can duster, a vat for dipping animals or plants, a spray-dip vat, a wiper applicator, or some fumigant applicators, no calibration is necessary.

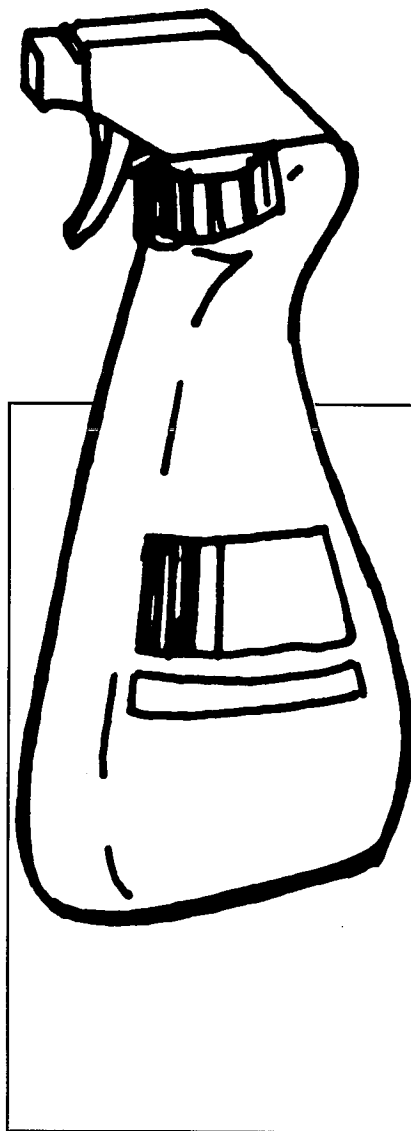

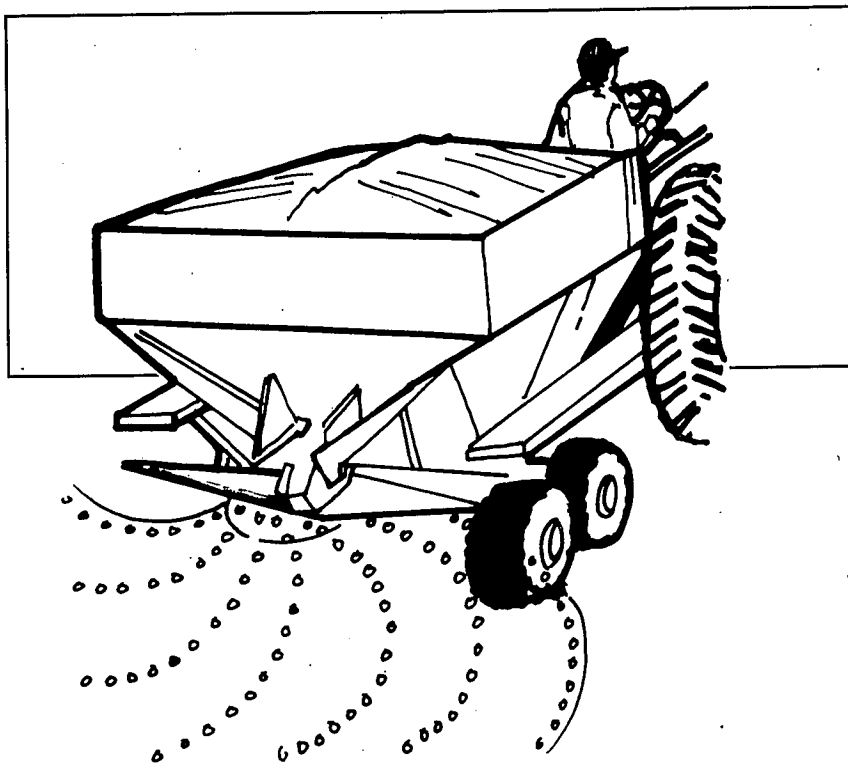

## Calibration, Mixing, and Loading Needed

Many concentrated pesticides are applied with equipment that must be calibrated. For many certified applicators, this is the option most commonly encountered. The concentrate must be diluted correctly and the equipment must be calibrated correctly. Both steps are crucial to applying the correct amount of pesticide to a target site. If there is an error either in dilution or in calibration, the wrong amount of pesticide will be applied.

## Calibrating Your Equipment

Most pesticide applications involve equipment that must be measured and adjusted to release the correct amount of pesticide to the target site. Proper calibration is an essential but often neglected task. To be sure your equipment is

## Calibration and Loading Needed, No Mixing

Ready-to-use formulations sometimes must be loaded into equipment that does require calibration. These include most granular and dust formulations, some liquid formulations (especially solutions), and some fumigant formulations. The pesticide is loaded directly into application equipment without any further dilution. The equipment must be calibrated so that the correct amount of pesticide will be released per unit area.

calibration. The applicator is instructed to “cover the plant, animal, or surface thoroughly” or “apply to the point of runoff.”

## Mixing and Loading Needed, No Calibration

Some concentrated pesticides are diluted and then loaded into equipment that does not require calibration. Many plant and animal dips or spray-dips, tree-canopy sprays, and crack and crevice treatments are applied by equipment that does not need

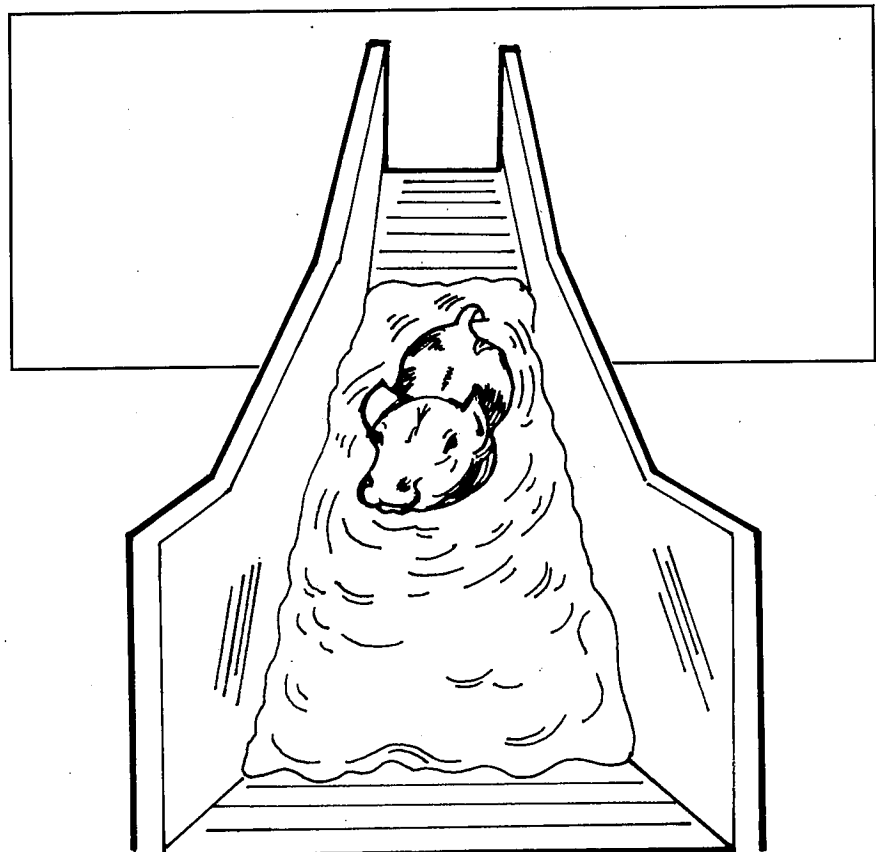

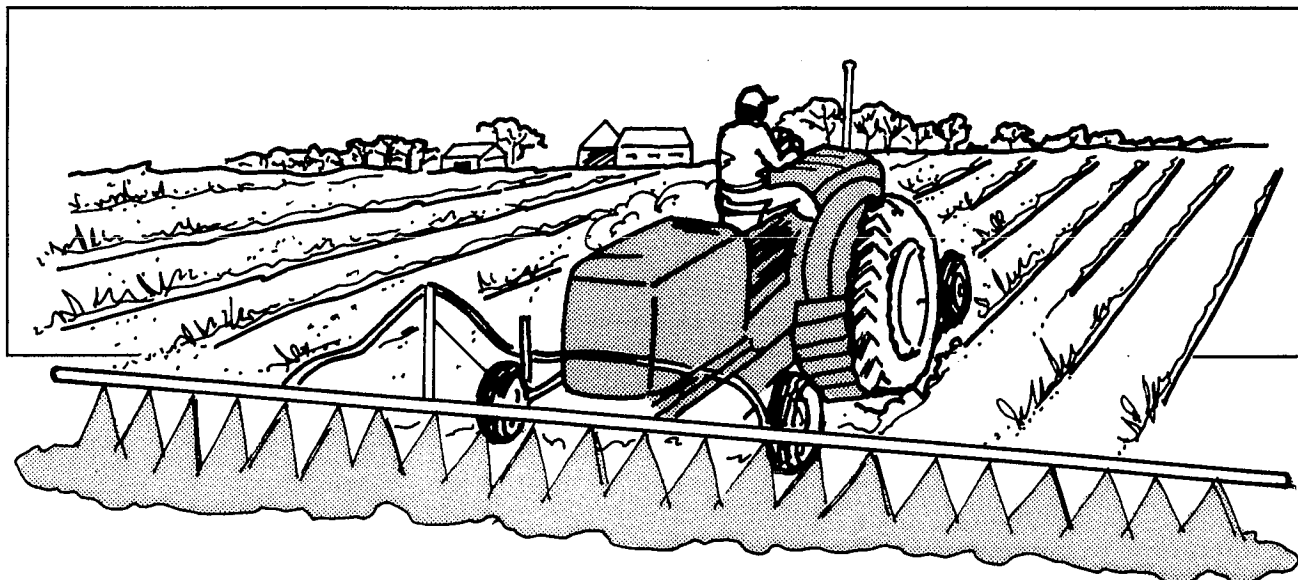

releasing the right amount of pesticide, take time to calibrate it carefully and correctly. Recheck it regularly to detect changes caused by wear, corrosion, and aging.

Calibration often requires some simple arithmetic. Usually the equipment manufacturer, the pesticide dealer, your industry organization, or the Cooperative Extension Service will provide some standard formulas to help you. The easiest and most accurate way to do the calculations is with a calculator.

Choose equipment that you know how to use and that is:

- designed for the type of chemical being applied, and

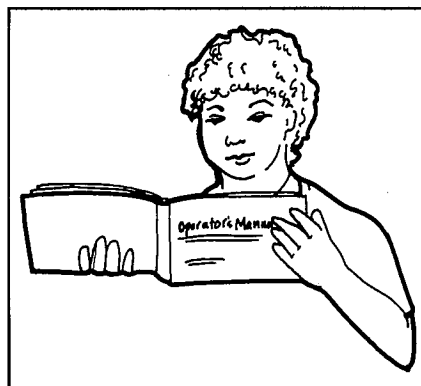

- appropriate for the size and type of application job.

Equipment will not deliver the right amount of pesticide to the target site if it is not working correctly. Before you begin to calibrate the equipment, check it carefully to be sure that all components are clean and in good working order. Pay particular attention to the parts that regulate the amount of pesticide being released, such as nozzles and hopper openings. If they become clogged, not enough pesticide will be released. If they become worn, too much pesticide will be released.

Equipment that must be calibrated includes mechanical dusters; granule spreaders; hand, backpack, boom, hand-gun, high-pressure, airblast, and most other sprayers; and fumigant applicators. The many types of application equipment differ in the details of their operation, but if you understand the basic principles of calibration, you can apply them in any situation. Study the

manufacturer's instructions carefully — they explain exactly how to adjust the equipment. They often contain suggestions on such things as the appropriate rate of travel, the range of most efficient pump pressures, approximate settings for achieving various delivery rates, and types of nozzles that can be used.

## Speed

For some types of application equipment, the speed at which the equipment moves (or is carried) through the target site is one of the main factors in determining the rate of application. For some other types of equipment, you do not need to consider speed when calibrating.

## Equipment with gravity-flow dispersal

If the equipment you have chosen uses gravity to maintain the flow of pesticide, calibration may be fairly simple. Some equipment, such as some granule spreaders, needs to be calibrated

only to adjust the rate of flow or delivery. This equipment releases pesticide only when the wheels are in motion. If the speed of the equipment is kept at an even, moderate pace, the amount of pesticide being released per unit area will be uniform.

### **Equipment with powered dispersal**

If your equipment has a pump or other mechanism to disperse the pesticide, you will need to determine the rate of speed best suited for the type of equipment and for the particular requirements of your application job. Such equipment may be either hand-carried or mounted on a vehicle. In either case, the speed at which the equipment moves through the target site determines the amount of pesticide applied in a given

area. Keep the speed as constant as possible during the calibration process and during the actual application. For the most accurate calibration, operate the equipment at the target site or on ground (or other surface) similar to that at the target site. Whether the equipment is hand-carried or mounted on a vehicle, the condition of the ground (surface) that must be crossed is important. A rough and uneven surface will cause the equipment to be operated at a slower speed.

The equipment manufacturer's directions may offer a range of appropriate speeds. Your knowledge of conditions in the target site (including the drift hazard), plus your experience with the equipment, will help you determine an appropriate speed.

### **Uniform Release**

If the application equipment you will be using has more than one nozzle (or more than 1 cluster of nozzles) or hopper, part of the calibration process is to measure the output from each to be sure that they all are releasing the correct amount of pesticide. Note whether the pesticide output from one or more nozzles (or cluster of nozzles) or hoppers is 5 percent more or less than the amount desired. Check for clogging or other obstruction in the openings that are distributing less. Check for leaks or worn parts in the openings that are distributing more. If you find no correctable problem, replace the nozzles or hoppers.

You can check for uniform output in two ways. Either method requires that you attach containers (jars) to collect the output from each nozzle, nozzle cluster, or hopper. Operate the equipment for a set period of time (1 to 5 minutes) and compare the amount of output in each jar to the amount desired. Or operate the equipment over a measured area while calibrating the equipment and, at the end of the calibration run, compare the amount of output in each jar to the amount desired. If all the nozzles or hoppers are intended to release an equal amount of pesticide, just check to see whether all the jars contain the same amount.

### **Calibration Methods**

No matter what calibration method you use, you will be measuring how much pesticide is being applied in a specific area. Calibration usually requires you to operate the equipment over a pre-measured distance.

The rate of application depends partly on the particle or droplet

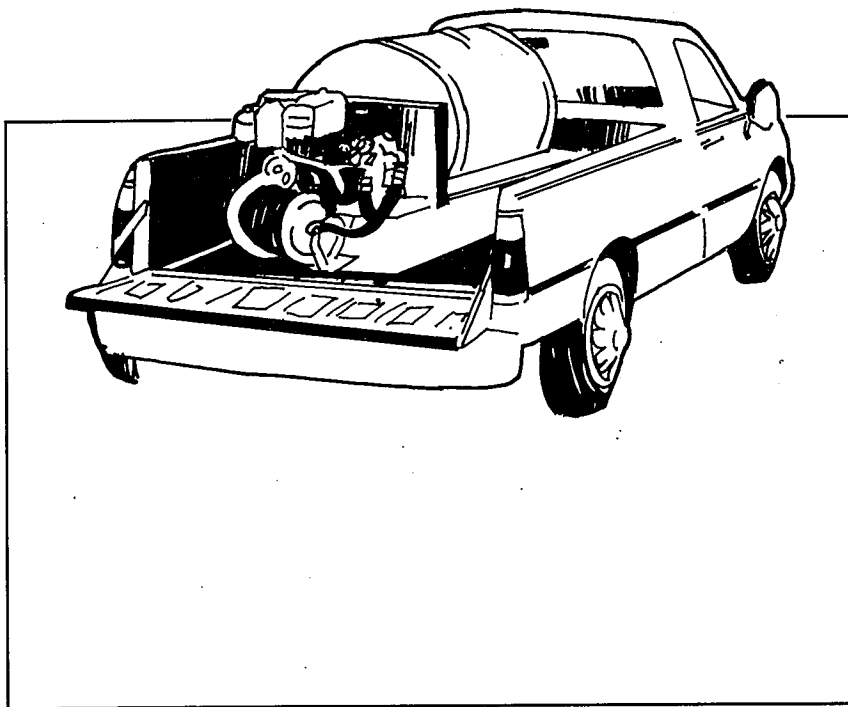

size, texture, and other properties of the pesticide being applied, so you will need to decide what material to use in the test. If the pesticide is a liquid with water as the major diluent, use water alone in the test. If the pesticide is a dust, granule, or fumigant, or a liquid diluted with a liquid other than water, you must use the actual pesticide in the test.

The rate of application sometimes depends also on the pressure and on the nozzle size or hopper opening. The equipment manufacturer's directions are the best guide to these selections.

### Do a Test Application

Calibrate your application equipment by:

- accurately measuring the amount in the tank or hopper,
- operating the equipment over the pre-measured distance while maintaining your chosen speed (if speed affects the delivery rate of the equipment you are using),
- accurately measuring the amount needed to fill the tank or hopper back up to the pre-application level.

If multiple nozzles or hoppers are used, you must add together the output of all the collection jars.

### Figure the Application Rate

The amount of pesticide dispersed, divided by the distance covered, is the application rate. Sometimes no calculations are needed. If, for example, the label lists the application rate as "per acre" or "per 1,000 linear feet" and you measure the output for exactly 1 acre or exactly 1,000 linear feet, no calculations are necessary because the amount of output you measured is the total amount required.

However, you may not have the time to test your equipment over such a large site. Or, if you are using the actual pesticide in the test, you may not want to risk applying it over a large site without knowing the application rate. Under these conditions, you can test smaller sites and then calculate the application rate.

### Small equipment, small target sites

If you are using application equipment that carries a relatively small load (up to a few gallons of liquid or a few pounds of dry pesticide) or if the target site is relatively small (less than an acre

or 1,000 linear feet), you can choose a test site that is small.

If the use directions are for 100 linear feet, you might choose a test site of 25 linear feet. If the directions are for 1,000 square feet or for an acre, you might choose a test site of 250 square feet (a 10-by 25-foot rectangle). Measure the amount applied in this smaller site and then multiply to find the rate:

- The amount applied to 25 linear feet, multiplied by 4, equals the rate per 100 linear feet.
- The amount applied to 250 square feet, multiplied by 4, equals the rate per 1,000 square feet.
- The amount applied to 250 square feet, multiplied by 175, equals the rate per acre.

### Larger equipment, larger target sites

If you are using application equipment that carries a larger load (more than a few gallons of liquid or a few pounds of dry pesticide) or if the target site is relatively large (greater than an acre or 1,000 linear feet), choose a larger test site. If the test site for these types of equipment or sites is too small, measurements are likely to be inaccurate. Operating a boom or other multi-nozzle or multi-hopper equipment over a site as small as 10 feet by 25 feet, for example, would not allow you to carry or drive the equipment far enough to gauge average speed accurately.

If label directions are for 1,000 square feet or for an acre, use a test site of at least 1,000 square feet (a 20- by 50-foot rectangle). The output you measure during the test will be the actual application rate for the 1,000 square feet. To find the rate per acre, multiply the test output by 43.56, which is the number of square feet in an acre (43,560) divided by 1,000.

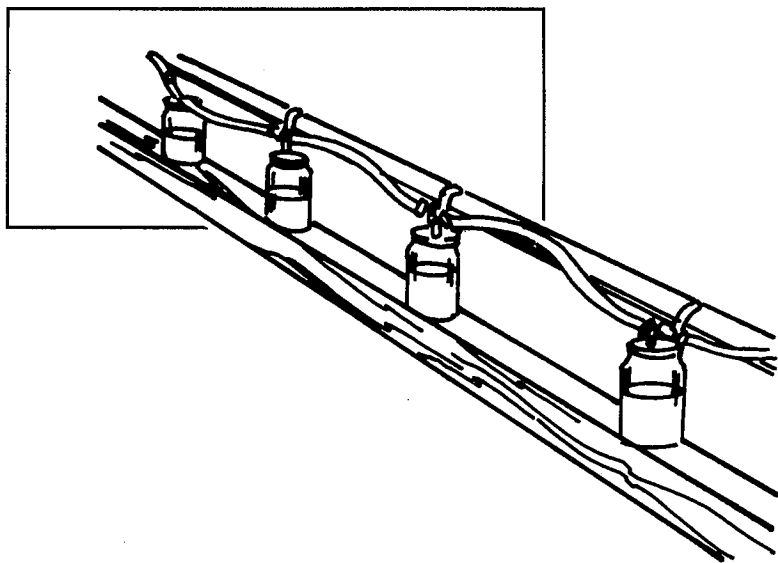

## Check Calibration Often

Once you have calibrated your equipment, do not assume that it will continue to deliver the same rate during all future applications. Clogging, corrosion, and wear may change the delivery rate, or the settings may gradually get out of adjustment. Taking the time to check the calibration of your equipment regularly is worth your while.

Be alert for possible calibration problems each time you use your application equipment. During the application, notice whether you are treating the same amount of area per load that you figured. If you find that you are covering more or less area than your figures indicated, stop application and check your figures and your equipment. If you have figured wrong or if your application equipment changes its delivery rate, you will be able to catch the mistake before you have a major problem.

## Measure Accurately

When you measure pesticides or diluents, measure accurately. Inaccurate measurements can lead to underdosing, overdosing, too much pesticide mixture left in the tank, or a tankload of the wrong strength of pesticide mixture.

Use graduated utensils. If you are measuring a dry formulation, use a scale to weigh out the exact number of pounds or ounces you need. If you are measuring a liquid formulation or diluent:

- use measuring spoons or a “tip and pour” to measure teaspoons or tablespoons,
- use a graduated measuring cup or a “tip and pour” to measure from 1/4 cup to 1 pint,
- use a graduated jug or pail to measure from 1 pint to 5 gallons,

■ use a flow meter to measure more than 5 gallons at a time.

Carefully measure the amount of pesticide to add. Do not guess or approximate the amount you are adding, and do not add a little extra “just to be sure.” Also measure the amount of diluent carefully. Adding the correct amount of concentrate to an approximated amount of diluent can result in a whole tankful of the wrong strength of pesticide mixture. Mix only the amount you have calculated is needed for the application.

Do not assume that the tank is exactly the size of its claimed capacity. A “5 gallon” tank may hold more or less than 5 gallons. A “100 gallon” tank often holds quite a bit more than 100 gallons when totally filled. Measure the tank yourself to be sure. Even the graduated marks on some tanks or hoppers that indicate levels of partial fill are often inaccurate.

You can measure the capacity of your tank and check (or make) gauges indicating partial fill levels in two ways. You can fill the tank by hand using a container of known capacity, such as a measuring cup for small tanks and a 5-gallon pail for larger tanks. Or you can attach a flow meter to a hose and measure the quantity of water as it flows into the tank. For either method, as you fill the tank, you should check or mark measured volumes on a dip stick or sight gauge.

If water or another liquid is being used to dilute the concentrate, rinse the measuring utensils with the diluent and put the rinsate into the mix tank. Repeat this three times to be sure all of the pesticide is removed from the measuring utensil.

Measure the amount of a ready-to-use formulation carefully, too. Trying to put pesticide back into the container when you have too much left over after the applica-

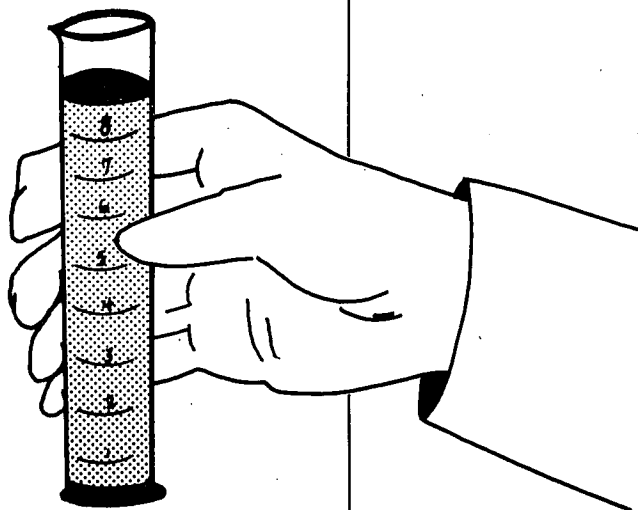

tion is often a difficult task. Add only the amount you have calculated is needed to complete the application job.

Measuring utensils, such as spoons, cups, jugs, pails and scales, that you use with pesticides should **never** be used for other purposes. Clean them thoroughly after each use and store them with your other pesticide equipment.

## Diluting Pesticides Correctly

Some of the pesticides you buy are **dilute** formulations that are sold at application strength. These often are labeled “Ready-To-Use” or “RTU.” But many pesticide formulations that you use are **concentrates**, which are sold at strengths many times that needed for application. These formulations must be diluted before you can apply them. They are usually powders or liquids. Granules and dusts are rarely sold as concentrates; fumigants and ultra-low-volume formulations are concentrates that are applied full strength.

The person who prepares the pesticide mixture for application must figure carefully how much concentrated pesticide to use and how much diluent to add to the concentrate. Unless the pesticide is diluted correctly, you can apply the wrong amount of pesticide in the target site.

Water is the most common diluent in pesticide mixtures.

Others that are sometimes used include other liquids, such as kerosene and oil; and dry ingredients, such as corn husks and various powders. Concentrated pesticides are either diluted in a “mix tank” and then loaded into the application equipment or loaded directly into the application equipment and diluted there.

The pesticide labeling or other recommendations will tell you:

- what to use to dilute the formulation,
- how much to dilute the formulation, and
- how much of the dilute pesticide to apply per unit of area.

After you determine how much you need to dilute the pesticide concentrate, you must calculate how much pesticide and diluent to combine to achieve the correct amount of dilute pesticide mixture in your application equipment. Depending on the situation, you may need to know:

- how much your equipment holds when full or how much mixture you will need to complete the job.
- how much mixture your equipment applies per unit of area,
- the size of the site you need to treat.

Guides that are available from many sources contain formulas and examples to help you make necessary calculations.

Pesticide labels express the desired dilution for the pesticide

mixture in a variety of ways, depending on the type of product and the primary intended uses. If your application situation is not the same as those on which the labeling directions were based, you may have to use some simple arithmetic to convert the quantities to different units of measure.

## Determining Size of Target Site

If the target site is a rectangle, circle, or triangle, you can use simple measurements and formulas to determine its size. Irregularly shaped sites often can be reduced to a combination of rectangles, circles, and triangles. Calculate the area of each and add them together to obtain the total area.

To apply fumigants and a few other pesticides to fill the entire inside of a structure or other enclosed space, you must calculate the volume (cubic feet) of the building, greenhouse, truck, railroad car, or ship hold. To apply pesticides to bodies of water (not just the surface), you must calculate the volume of the water in the pond or lake. Sometimes the structures or bodies of water are regular in shape. The calculations for these are fairly simple. If the structure or body of water is irregular, you must calculate parts of the structure separately and add them together to find the total volume.



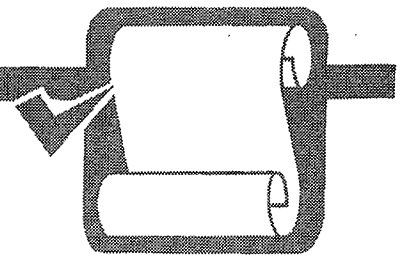

## Test Your Knowledge

**Q.** Why is it so important to apply the correct amount of pesticide to the target site?

**A.** If you apply too little pesticide, you may not fully control the pest. Overdosing may cause damage or injuries, leave illegal residues, and cause you to be fined or to be liable for damages.

**Q.** Where can you find out how much pesticide to apply?

**A.** From the "Directions for Use" section of the pesticide labeling, and from other sources, such as consultants, industry organizations, pest or pesticide specialists, Cooperative Extension agents, university specialists, or pesticide dealers.

**Q.** What are some of the ways that application rates may be stated?

**A.**

1. Amount of formulation per unit of area or per unit of volume, such as pounds or gallons per acre, per square feet, or per cubic feet.
2. Amount of formulation per volume of mixture, such as 3 tablespoons of product per 5 gallons of kerosene or 1 pint of product per 100 gallons of water.
3. Amount of active ingredient per

unit of area or per volume of mixture, such as 1 pint active ingredient per 1,000 square feet, or 1/2 pound active ingredient per 500 gallons of water.

4. Percentage of the final dilution, such as 1/2 percent by volume or 1 percent by weight.

**Q.** Why is it important to calibrate some types of pesticide application equipment?

**A.** Many types of pesticide application equipment must be calibrated so that the correct amount of pesticide will be released to the target site.

**Q.** How do you calculate the application rate?

**A.** The amount of pesticide dispersed, divided by the distance covered, is the application rate.

**Q.** Why should you recheck equipment calibration frequently?

**A.** Clogging, corrosion, and wear may change the delivery rate, or the settings may gradually get out of adjustment.

**Q.** What pesticide formulations must be diluted before application?

**A.** You must dilute all formulations except those that are sold as ready-to-use products or those designed to be applied full strength.

**Q.** What information do you need to get from the pesticide labeling or other sources before you can dilute pesticides correctly?

**A.** Read the pesticide labeling or consult recommendations from other sources to find out what to use to dilute the formulation; how much to dilute the formulation; and how much of the dilute pesticide to apply per unit of area.

**Q.** What information do you need to know about your own situation before you can calculate how much pesticide and diluent to combine to achieve the correct amount of dilute pesticide mixture in your application equipment?

**A.** You must know how much your equipment holds when full or how much mixture you will need to complete the job; how much mixture your equipment applies per unit of area; and the size of the site you need to treat.



# Transportation, Storage, Disposal, and Spill Cleanup

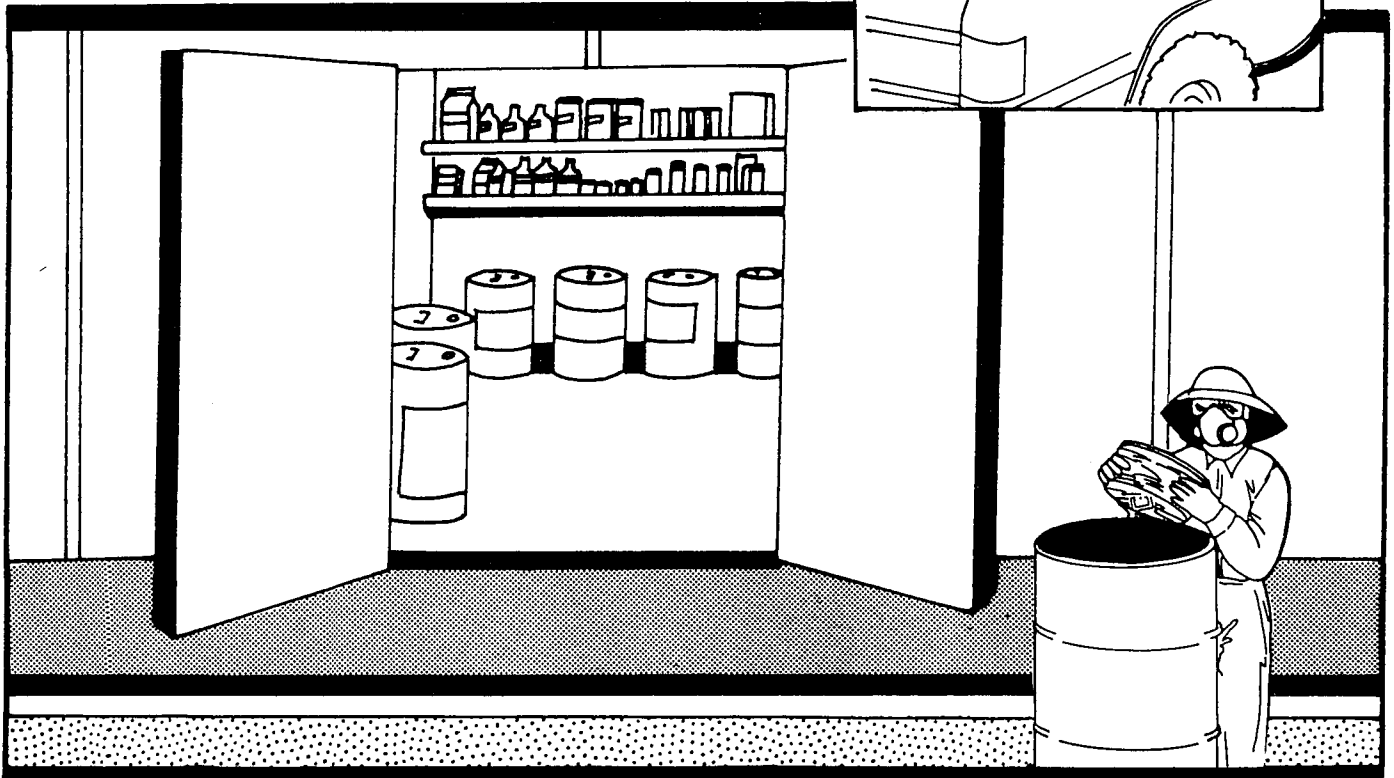
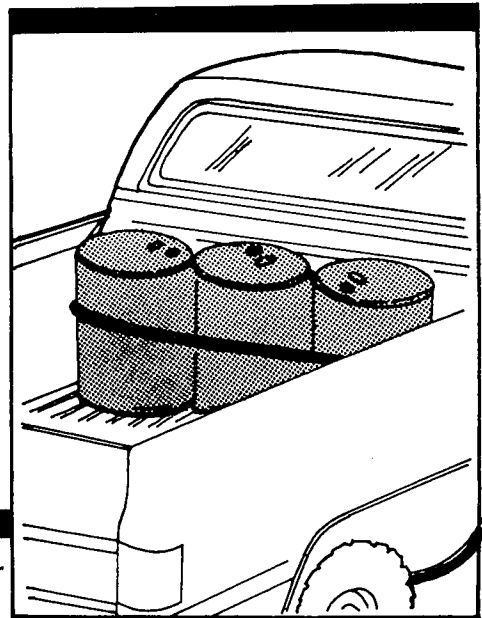
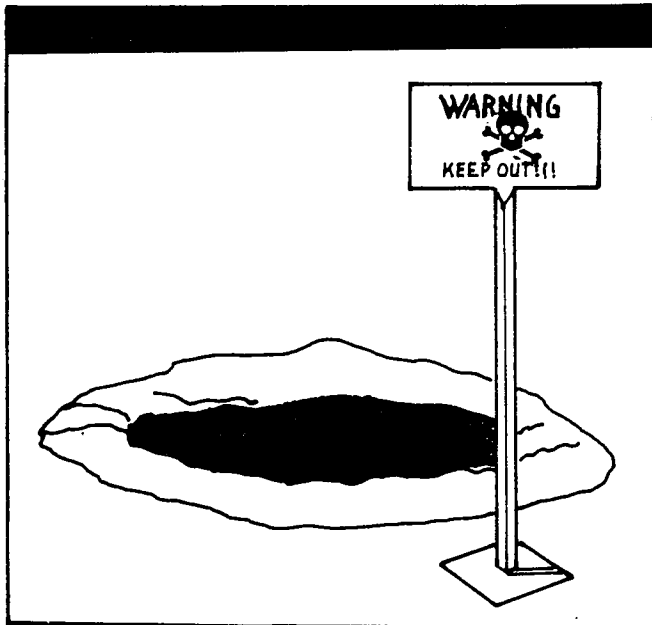

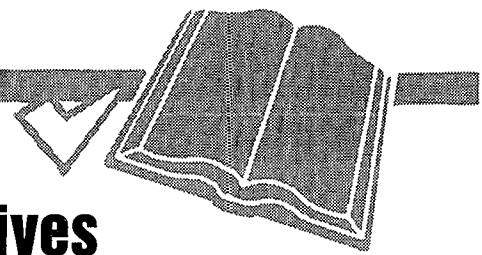
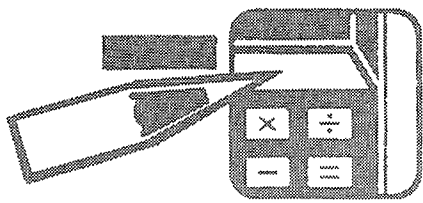

## Learning Objectives

After you complete your study of this unit, you should be able to:

- List safety precautions for transporting pesticides in a vehicle.
- Describe how to protect pesticide containers during transport.

- Name actions needed to establish and maintain a safe storage site.
- Describe what to do when a pesticide container leaks.
- Explain what to do with excess pesticides that are still usable.
- List acceptable ways to dispose of pesticide wastes.

- List ways to avoid the need to dispose of pesticide containers.
- Explain the “three C’s” of spill management and steps to take in each.
- List sources of assistance for managing a spill.
- Explain when a spill kit should be on hand.

## Terms To Know

**Active ingredients**— The chemicals in a pesticide product that control the target pest.

**Chemical-resistant**— Able to prevent movement of the pesticide through the material during the period of use.

**Collection pad**— A safety system designed to contain and recover spills, leaks, rinsates, and other pesticide-containing substances.

**Decontaminate**— Remove pesticide from surfaces or organisms that are exposed so no further harm or damage can occur.

**Diluent**— Anything used to dilute a pesticide.

**Drift**— Pesticide movement away from the release site in the air.

**Exposure**— Coming into contact with a pesticide; getting a pesticide on a surface or in or on an organism.

**Eyewash dispenser**— Commercially available system for flushing contaminants out of the eyes.

**Fumigant**— Pesticide that is a vapor or gas or that forms a vapor or gas when applied and whose pesticidal action occurs in the gaseous state.

**Ground water**— Water beneath the earth’s surface in soil or rock.

**Labeling**— The pesticide product label and other accompanying materials that contain directions that pesticide users are legally required to follow.

**Nonporous surfaces**— Surfaces that have no openings to allow liquid to be absorbed or pass through.

**OSHA**— Occupational Safety and Health Administration in the United States Department of Labor.

**Personal protective equipment (PPE)**— Devices and clothing worn to protect the human body from contact with pesticides or pesticide residues.

**Pesticide handler**— Person who directly works with pesticides, such as during mixing, loading, transporting, storing,

disposing, and applying, or working on pesticide equipment.

**Petroleum-based**— Made from petroleum products.

**Runoff**— The movement of pesticide away from the release site in water or another liquid flowing horizontally across the surface.

**Sensitive**— Particularly vulnerable to harm from pesticide exposure.

**Solvent**— A liquid, such as water, kerosene, xylene, or alcohol, that will dissolve a pesticide (or other substance) to form a solution.

**Surface water**— Water on top of the earth’s surface, such as in lakes, streams, rivers, irrigation ditches, or storm water drains.

**Toxicity**— Measure of a pesticide’s ability to cause acute, delayed or allergic effects.

**Volatile**— Evaporating rapidly; turning easily into a gas or vapor.

**W**hen you transport, store, or dispose of pesticides and their containers, you must take safety precautions. You can prevent many pesticide accidents, and reduce the severity of others, if you are prepared before you start these tasks. Before you begin any pesticide handling task, know what do to in case of spills and have the proper spill cleanup equipment on hand.

## Transportation of Pesticides

You are responsible for the safe transport of pesticides in your possession. Carelessness in transporting pesticides can result in broken containers, spills, environmental contamination, and harm to yourself and others. Accidents can occur even when you are transporting materials a short distance. Do all you can to prevent a mishap, but be prepared in case of emergency. Before transporting pesticides, you should know what to do if a spill occurs. If any pesticide is spilled in or from the vehicle, take action right away to make sure the spill is cleaned up correctly.



### Vehicle Safety

The safest way to transport pesticides is in the back of a truck. Flatbed trucks should have side and tail racks. Steel or plastic-lined beds are best, because they can be more easily cleaned if a spill occurs.

**Never** carry pesticides in the passenger section of your car, van, or truck. Hazardous vapors may be released and make the driver and other passengers ill. Pesticides may cause illness or injury if they spill on you or your passengers. It is nearly impossible to completely remove spills from the fabric of seats and floor mats. They can cause future contamination if they are not cleaned up correctly. If you must transport pesticides in the back of a station wagon, open the side windows and do not allow anyone to ride in the back.

**Never** allow children, other passengers, and pets to ride with pesticides.

**Never** transport pesticides with food, clothing, or other things meant to be eaten by or in contact with people or animals. The risk of contamination is too high. Even small amounts of pesticide could contaminate these highly sensitive items. A spill could cause major injury.

**Never** leave your vehicle unattended when transporting pesticides in an unlocked trunk compartment or open-bed truck. You are responsible and liable if curious children or careless adults are accidentally poisoned by the pesticides. Whenever possible, transport pesticides in a locked compartment.

**Consider** transporting highly volatile pesticides in separate trips from other chemicals. Spills, or even fumes from opened containers, can make the other chemicals worthless.

## Transporting Pesticide Containers

Transport pesticides only in containers with intact, undamaged, and readable labels. Inspect containers before loading to be sure that all caps, plugs, and other openings are tightly closed and that there are no pesticides on the outside of the containers. Handle containers carefully to avoid rips or punctures.

Anchor all containers securely to keep them from rolling or sliding. Packing or shipping containers provide extra cushioning. Protect paper and cardboard containers from moisture, because they become soggy and split easily when wet.

Protect pesticides from extreme temperatures during transport. Extremely hot or cold temperatures can damage pesticide containers by causing them to melt or become brittle. Such temperatures also may reduce the usefulness of the pesticides.

## Labeling Statements About Transportation

Typical pesticide labeling instructions about transportation include:

*Do not ship with food, feeds, drugs, or clothing.*

*Do not transport damaged or leaking container.*

*In case of a transportation emergency involving a spill, fire, or exposure, call [telephone number] 24 hours a day.*

*Do not transport in or on vehicles containing foodstuffs or feeds.*

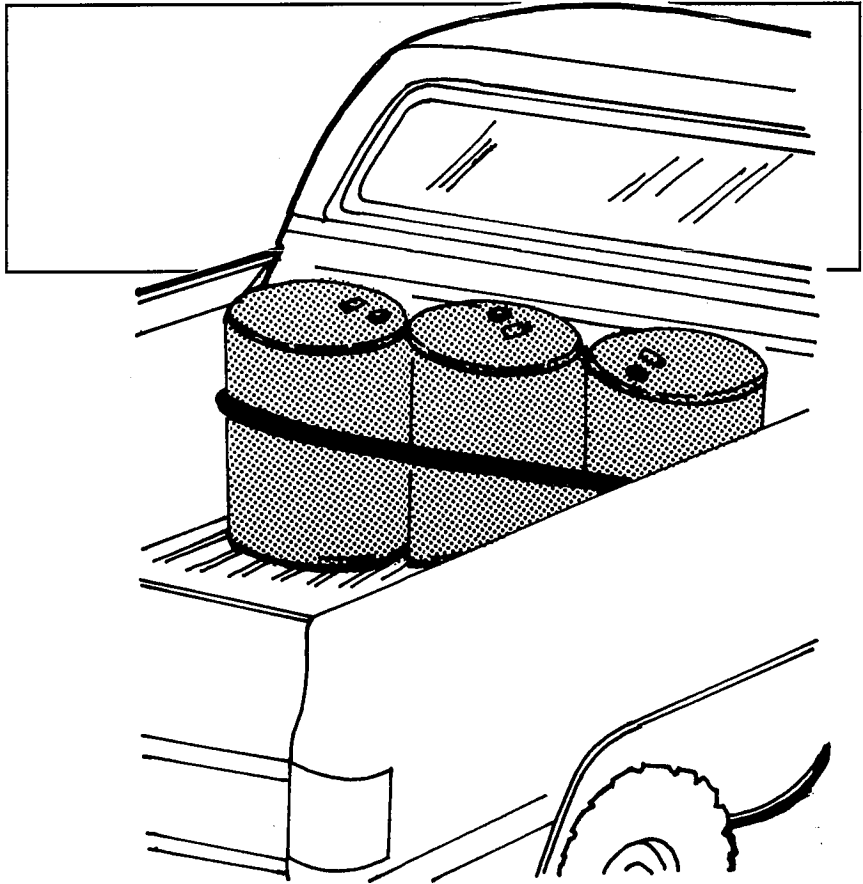

## Pesticide Storage

Many pesticide handlers use existing buildings or areas within existing buildings for pesticide storage. However, if large

amounts of pesticides will be stored, it is best to build a special storage building just for pesticide needs.

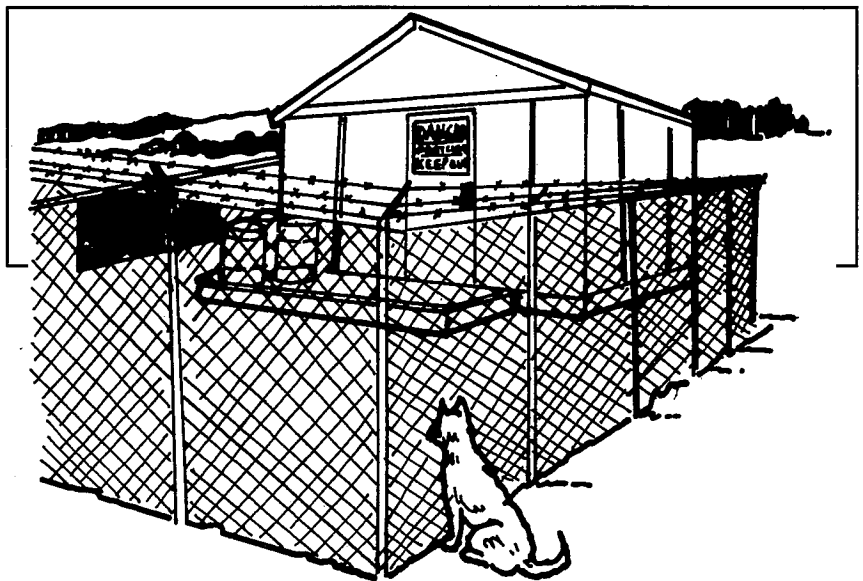

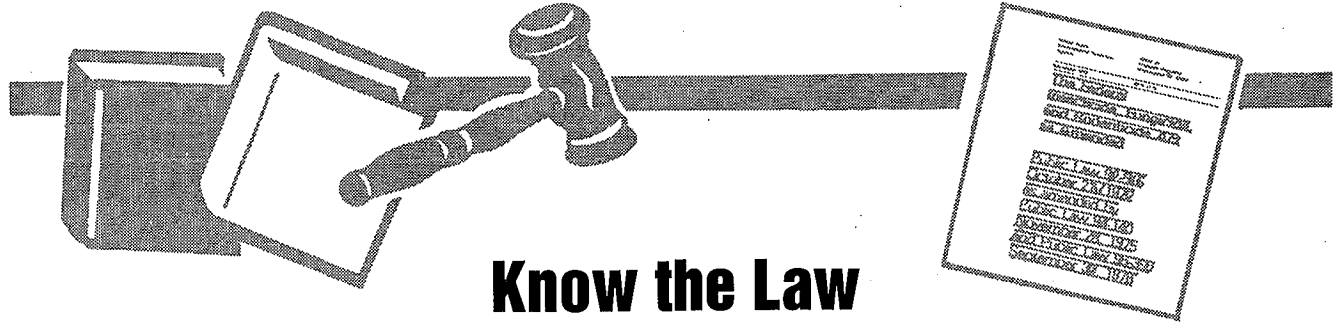

## Know the Law

Some pesticide applicators, applicator businesses, and dealers may be affected by Title III of the Superfund Amendments and Reauthorization Act of 1986 (**SARA Title III**), administered by the Environmental Protection Agency. SARA Title III has many sections; three relate to the storage of pesticides:

### Emergency planning and notification

Under certain conditions, the law requires you to notify State and local officials about the location and amount of hazardous chemicals at your site. EPA has assigned a Threshold Planning Quantity (TPQ) for a number of active ingredients (not total weight of formulated product). When the product in

storage is at or above the TPQ, you must notify the State Emergency Response Commission (SERC) in writing. Each facility must designate a coordinator to work with the Local Emergency Planning Committee (LEPC). The State will notify the LEPC that your operation is covered under SARA. This is a one-time notification.

### Material Safety Data Sheet (MSDS) reporting

Employers are required to obtain and keep material safety data sheets. They must submit copies of each MSDS (or a listing of MSDS's that must be maintained) to their local fire department, the LEPC, and the SERC. There is one exclusion: if a chemical is used solely for household, consumer, or agricultural

purposes, notification is not required. However, under OSHA regulations, pesticide users (except homeowners) must have the MSDS for each pesticide they handle.

### Annual inventory reporting

All regulated facilities must submit an annual chemical inventory to their local fire department, LEPC, and SERC. This inventory must include:

- all hazardous chemicals stored at the facility in quantities of 10,000 pounds or more, and
- all extremely hazardous chemicals stored in quantities of 500 pounds (or 55 gallons) or more, or in a quantity that exceeds the TPQ, whichever is less.

Agricultural producers are exempt from this section.

### Establish a Storage Site

A correctly designed and maintained pesticide storage site is essential. A suitable storage site:

- protects people and animals from accidental exposure,
- protects the environment from accidental contamination,
- prevents damage to pesticides from temperature extremes and excess moisture,
- protects the pesticides from theft, vandalism, and unauthorized use, and
- reduces the likelihood of liability.

### Secure the site

Keeping out unauthorized people is an important function of

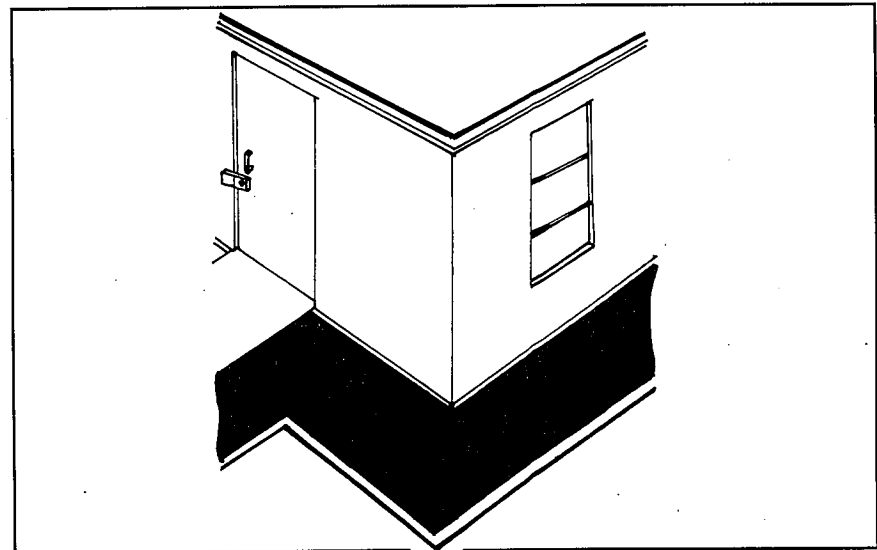

the storage site. Whether the storage site is as small as a cabinet or closet or as large as an entire room or building, keep it securely

locked. Post signs on doors and windows to alert people that pesticides are stored there. Post "No smoking" warnings.



## Prevent water damage

Choose a storage site where water damage is unlikely to occur. Water from burst pipes, spills, overflows, excess rain or irrigation, or flooding streams can damage pesticide containers and pesticides. Water or excess moisture can cause:

- metal containers to rust,
- paper and cardboard containers to split or crumble,
- pesticide labeling to peel, smear, run, or otherwise become unreadable,
- dry pesticides to clump, degrade, or dissolve,
- slow-release products to release their pesticide, and
- pesticides to move from the storage site into other areas.

If the storage site is not protected from the weather or if it tends to be damp, consider placing metal, cardboard, and paper containers in sturdy plastic bags or cans for protection. Large metal containers, which may rust when damp, often can be placed on pallets within the storage site.

## Control the temperature

The storage site should be indoors, whenever possible. Choose a cool, well-ventilated room or building that is insulated or temperature-controlled to prevent freezing or overheating. The pesticide labeling may tell you at what temperatures the product should be stored. Freezing temperatures can cause glass, metal, and plastic containers to break. Excessive heat can cause plastic containers to melt, some glass containers to explode, and some pesticides to volatilize and drift away from the storage site. Temperature extremes can destroy the potency of some pesticides.

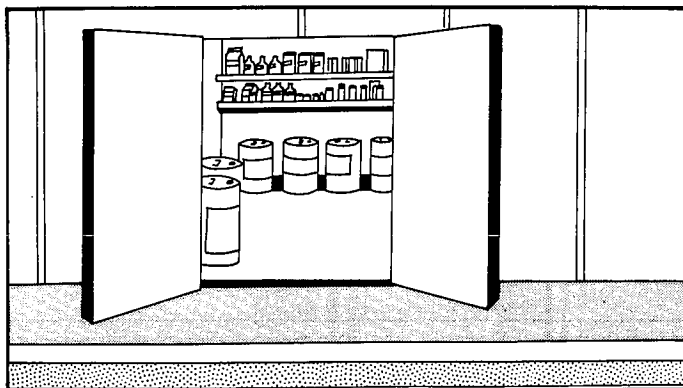

## Provide adequate lighting

The storage site should be well lit. Pesticide handlers using the facility must be able to see well enough to:

- read pesticide container labeling,
- notice whether containers are leaking, corroding, or otherwise disintegrating, and
- clean up spills or leaks completely.

## Use nonporous materials

The floor of the storage site should be made of sealed cement, glazed ceramic tile, no-wax sheet flooring, or another easily cleaned material. Carpeting, wood, soil, and other absorbent floors are difficult or impossible to decontaminate in case of a leak or spill. For ease of cleanup, shelving and pallets should be made of nonabsorbent materials such as plastic or metal. If wood or fiberboard materials are used, they should be

coated or covered with plastic or polyurethane or epoxy paint.

## Prevent runoff

Inspect the storage site to determine the likely path of pesticides in case of spills, leaks, drainage of equipment wash water, and heavy pesticide runoff from firefighting or floods. Pesticide movement away from the storage site could contaminate sensitive areas, including surface water or ground water. If your storage site contains large amounts of pesticides, you may need to use a collection pad to contain pesticide runoff.

## Provide clean water

Each storage site must have an immediate supply of clean water. Potable running water is ideal. If running water is not practical, use a carboy or other large, sealable container with clean water. Changing the water in a container at least once each week will ensure that it remains safe for use on skin and eyes. Keep an eye-wash dispenser immediately available for emergencies.

## Maintain the Storage Site Prevent contamination

Store only pesticides, pesticide containers, pesticide equipment, and a spill cleanup kit at the storage site. Do not keep food, drinks, tobacco, feed, medical or

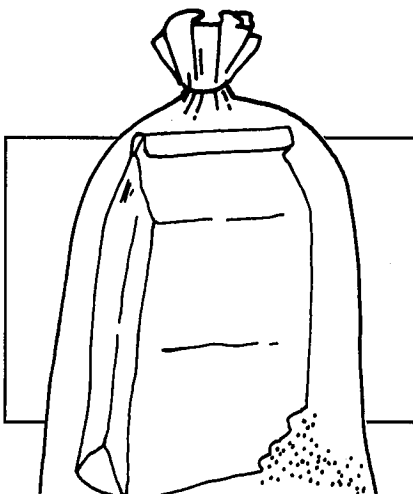



veterinary supplies or medication, seeds, clothing, or personal protective equipment (other than personal protective equipment necessary for emergency response) at the site. These could be contaminated by vapors, dusts, or spills and cause accidental exposure to people or animals.

### Keep labels legible

Store pesticide containers with the label in plain sight. Costly errors can result if the wrong pesticide is chosen by mistake. Labels should always be legible. They may be damaged or destroyed by exposure to moisture, dripping pesticide, diluents, or dirt. You can use transparent tape or a coating of lacquer or polyurethane to protect the label. If the label is destroyed or damaged, request a replacement from the pesticide dealer or the pesticide formulator immediately.

### Keep containers closed

Keep pesticide containers securely closed whenever they are being stored. Tightly closed containers help protect against:

- a spill,
- cross-contamination with other stored products,
- evaporation of liquid pesticides or the solvent,
- clumping or caking of dry pesticides in humid conditions, and
- dust, dirt, and other contaminants getting into the pesticide, causing it to be unusable.

### Use original containers

Store pesticides in their original containers. Never put pesticides in containers that might cause children and other people to mistake them for food or drink. You are legally responsible if someone or something is injured

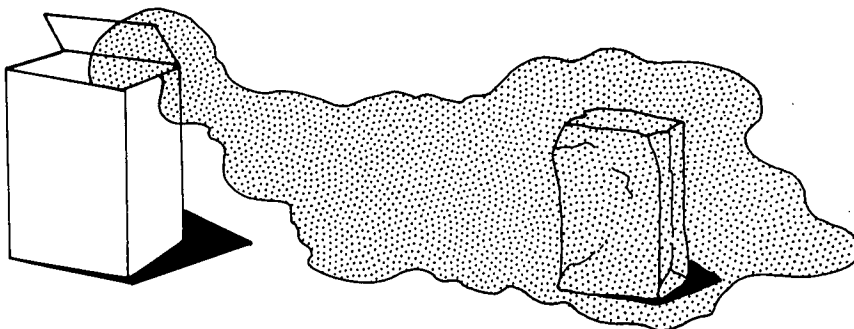

by pesticides you have placed in unlabeled or unsuitable containers.

### Watch for damage

Inspect containers regularly for tears, splits, breaks, leaks, rust, or corrosion. When a container is damaged, put on appropriate personal protective equipment and take immediate action. If the damaged container is an aerosol can or fumigant tank that contains pesticides under pressure, use special care to avoid accidentally releasing the pesticide into the air. When a container is damaged:

- Use the pesticide immediately at a site and rate allowed by the label, or
- Transfer the pesticide into another pesticide container that originally held the same pesticide and has the same label still intact, or
- Transfer the contents to a sturdy container that can be tightly closed. If possible, remove the label from the damaged container and use it on the new container. Otherwise, temporarily mark the new container with the name and EPA registration number of the pesticide, and get a copy of the label from the pesticide dealer or formulator (whose telephone number is usually on the label) as soon as possible, or
- Place the entire damaged container and its contents into a suitable larger container. Consider this option carefully, however. Many times the label on the leaking container becomes

illegible. The pesticide is useless and becomes a disposal problem unless you know the name and registration number and can get a copy of the label.

### Store volatile products separately

Volatile pesticides, such as some types of 2,4-D, should be stored apart from other types of pesticides and other chemicals. A separate room is ideal. Vapors from opened containers of these pesticide can move into other nearby pesticides and chemicals and make them useless. The labeling of volatile herbicides usually will direct you to store them separately from seeds, fertilizers, and other types of pesticides.

### Isolate waste products

If you have pesticides and pesticide containers that are being held for disposal, store them in a special section of the storage site. Accidental use of pesticides meant for disposal can be a costly mistake. Clearly mark containers that have been triple rinsed or cleaned by an equivalent method, because they are more easily disposed of than unrinsed containers.

### Know your inventory

Keep an up-to-date inventory of the pesticides you have in storage. Each time a pesticide is added to or removed from the storage site, update the inventory list. The list

will help you keep track of your stock and will be essential in a fire or flood emergency. The inventory list also will aid in insurance settlements and in estimating future pesticide needs.

Do not store unnecessarily large quantities of pesticides for long periods of time. Buy only as much as you will need for a year at most. Pests, pesticides, or pesticide registrations may change by the next year and make the pesticides useless. Some pesticides have a relatively short shelf life and cannot be carried over from year to year.

### Consider shelf life

Mark each pesticide container with the date of purchase before it is stored. Use older materials first. If the product has a shelf life listed in the labeling, the purchase date will indicate whether it is still usable. Excessive clumping, poor suspension, layering, or abnormal coloration may be indications that the pesticide has broken down. However, sometimes pesticide deterioration from age or poor storage conditions becomes obvious only after application. Poor pest control or damage to the treated surface can occur. If you have doubts about the shelf life of a pesticide, call the dealer or manufacturer for advice.

### Prevent Pesticide Fires

Some pesticides are highly flammable; others do not catch

fire easily. The labeling of pesticides that require extra precautions often will contain a warning statement in either the "Physical/Chemical Hazards" section or the "Storage and Disposal" section.

Pesticides that contain oils or petroleum-based solvents are the ones most likely to contain these warning statements. Some dry products also present fire and explosion hazards.

Store combustible pesticides away from open flames and other heat sources, such as steam lines, heating systems, kerosene heaters or other space heaters, gas-powered equipment, or incinerators. Do not store glass containers in sunlight where they can focus the heat rays and possibly explode or ignite. Install fire detection systems in large storage sites, and equip each storage site with a working fire extinguisher that is approved for all types of fires, including chemical fires.

If you store highly toxic pesticides or large amounts of any pesticides, inform your local fire department, hospital, public health officials, and police of the location of your pesticide storage building before a fire emergency occurs. Tell fire department officials what types of pesticides are regularly stored at the site, give them a floor plan, and work with them to develop an emergency response plan.

## Labeling Statements About Storage

Typical pesticide labeling instructions about storage include:

*Store at temperatures above 32 °F.*

*Do not contaminate feed, foodstuffs, or drinking water during storage.*

*Store in original container only.*

*In outside storage areas, store drums on sides to avoid accumulation of rain water in top or bottom of recessed areas.*

*Do not store near ignition sources such as electrical sparks, flames, or heated surfaces.*

*Flammable. Do not use, pour, spill, or store near heat or open flame. Do not cut or weld container.*

## Disposal

Pesticide users are responsible for correctly dealing with empty pesticide containers, excess usable pesticides, and waste materials that contain pesticides or their residues. There is growing concern about the serious harm to humans and the environment that incorrect disposal of pesticide wastes can cause. For information on disposal options available in your local area, contact your State or tribal pesticide authority.

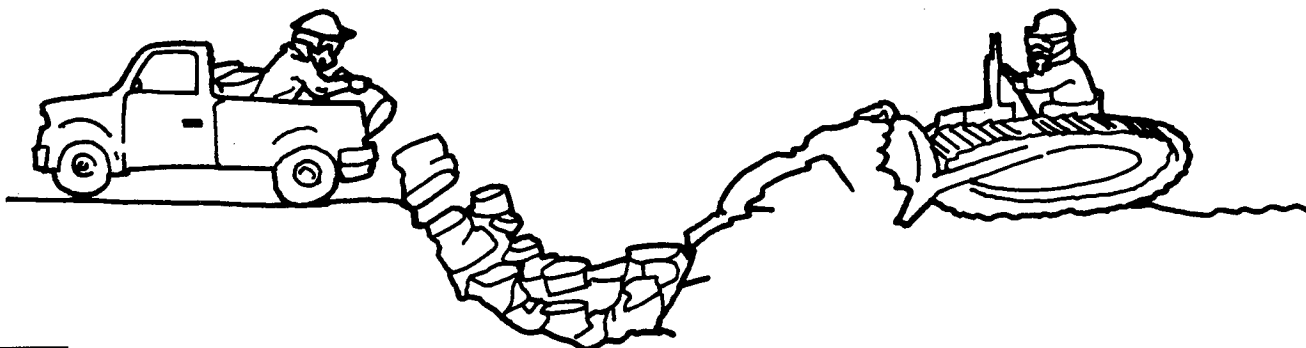

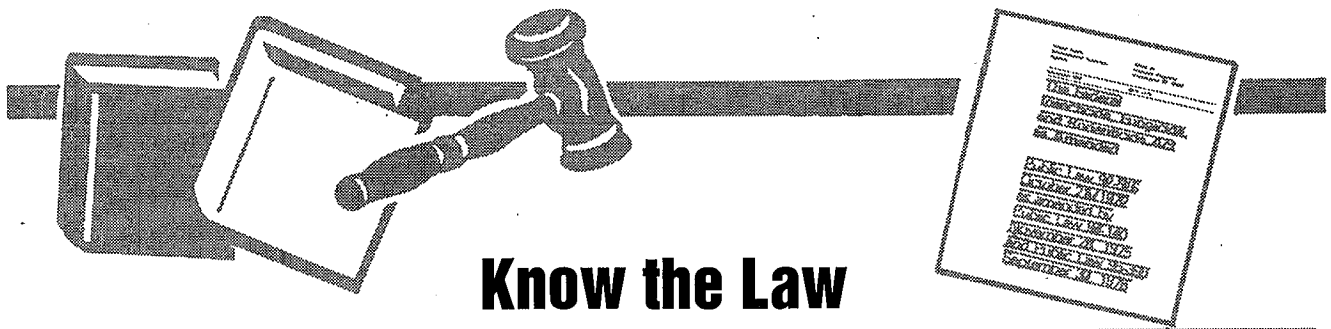

## Know the Law

The U.S. Environmental Protection Agency (EPA) regulates wastes under the **Resource Conservation and Recovery Act (RCRA)**. EPA issues a list of materials that are considered hazardous. However, RCRA applies to certain flammable, corrosive, reactive, or toxic wastes, even if they are not on the list. Therefore, some other pesticides could be "regulated hazardous wastes" under RCRA. States and tribes often have their own hazardous waste laws, which may be more stringent than

RCRA. Contact your State or tribal authority for applicable requirements.

"Wastes" include unrinsed containers, excess pesticides and pesticide dilutions, and rinse and wash water that contain a listed chemical and cannot be used. Triple-rinsed pesticide containers are not considered hazardous waste under RCRA, however. They can be disposed of in sanitary landfills.

RCRA regulates pesticide users who accumulate wastes of acutely toxic pesticides totaling 2.2

pounds or more per month or wastes of any RCRA-regulated pesticides totaling 2,200 pounds per month. Such users must register as a generator of hazardous waste, obtain an ID number from EPA, State, or tribe and follow certain disposal requirements.

To find out if a pesticide is listed in RCRA, call:

**EPA RCRA Hotline 1-800-424-9346**

**8:30 a.m. - 7:30 p.m. EST,  
Monday through Friday.**

### Excess Pesticides

The best solution to the problem of what to do with excess pesticides is to take steps to avoid having them:

- Buy only the amount needed for a year or a season.
- Calculate carefully how much diluted pesticide is needed for a job and mix only that amount.
- Use all the mixed pesticide in accordance with labeling instructions.

If you have excess pesticides that are usable, first try to find a way to use them as directed on the label. The best option is to **apply the pesticide** on a site listed in the use directions on the pesticide labeling, under the following conditions:

- The total amount of pesticide active ingredient applied to the site, including all previous applications, must not exceed the rate and frequency allowed on the labeling.
- You must comply with other application instructions specified

on the labeling.

If you have pesticide products in their original containers that you cannot use, you may be able to find another pesticide handler who can. Or you may be able to return them to a dealer, formulator, or manufacturer.

Most container rinsates should not become excess pesticides, because they can be added into the tank during the mixing process. You also may be able to add some rinsates from equipment cleaning, spill cleanup, and other activities to a tank mixture that contains the same pesticide, as long as doing so will not violate labeling instructions. Some rinsates will contain dirt, cleaning agents, or other substances that will make them unusable, however.

### Pesticide Wastes

Excess pesticides and rinsates that cannot be used must be disposed of as wastes. Other pesticide wastes include such things as contaminated spill

cleanup material and personal protective equipment items that cannot be cleaned and reused. Whenever possible, avoid creating pesticide wastes that require disposal.

Sometimes pesticide wastes can be disposed of in a landfill operating under EPA, State, tribal, or local permit for hazardous wastes. Most sanitary landfills are not suitable. Some regions have pesticide incinerators for disposing of pesticide wastes. Never burn, bury, or dump excess pesticides, and never dispose of them in a way that will contaminate public or private ground water or surface water or sewage treatment facilities.

Pesticide wastes that cannot be disposed of right away should be marked to indicate the contents and then stored safely and correctly until disposal is possible.

## Labeling statements about waste disposal

Typical pesticide labeling instructions about disposal of pesticide wastes include:

*Do not contaminate water by disposal of wastes.*

*Pesticide wastes are toxic. Improper disposal of excess pesticide is a violation of Federal law. If these wastes cannot be disposed of by use according to label instructions, contact your State Pesticide or Environmental Control Agency, or the Hazardous Waste representative at the nearest EPA Regional Office for guidance.*

## Containers

Try to avoid the need to dispose of pesticide containers as wastes. For example, you may be able to:

- use containers that are designed to be refilled by the pesticide dealer or the chemical company,
- arrange to have the empty containers recycled or reconditioned, or
- use soluble packaging.

If you have containers that you must dispose of, be sure to rinse them, if possible. Rinsed containers are easier to dispose of than unrinsed containers.

## Refillable containers

Some types of containers are designed to be refilled with pesticide repeatedly during their lifetime, which may be many years. They usually are not designed to be triple rinsed or pressure rinsed by the pesticide user. When necessary, they are cleaned by the pesticide dealer or chemical company before refilling. Common types of refillable containers include minibulks and small-volume returnables.

## Recyclable and reconditionable containers

You may be able to take your rinsed metal or plastic containers to a facility that can recycle them. Some 55- and 30-gallon drums can be returned to the dealer, manufacturer, or formulator to be reconditioned and reused.

## Soluble containers

Soluble containers are designed to be placed, unopened, into the mixing tank. The container dissolves in the solvent (usually water) in the tank. Only the over-packaging remains, and it may be disposed of as nonhazardous waste in a sanitary landfill.

## Triple-rinsed or pressure-rinsed containers

Containers that have been correctly triple rinsed or pressure rinsed usually may be disposed of

as regular trash in a sanitary landfill, unless prohibited by the pesticide labeling or by State, tribal, or local authorities. Mark the containers to show that they have been rinsed.

## Unrinsed containers

To dispose of unrinsed containers, you may take them to an incinerator or landfill operating under EPA, State, or tribal permit for hazardous waste disposal. If this is not possible, check with your State, tribal, or local authorities to find out what to do. Otherwise, you may need to store the containers until you have a way to dispose of them.

## Burnable containers

The labeling of some paper, cardboard, and plastic containers may list "burning, if allowed by State and local authorities" as a disposal option for pesticide containers. However, open burning of pesticide containers and waste pesticides is a questionable practice and may be in violation of Federal regulations that could take precedence over the instructions on the pesticide labeling. Because of possible air pollution hazard and the risks of liability, your best option is to use another disposal method for these containers.

## Labeling statements about container disposal

Typical pesticide labeling instructions about disposal of pesticide containers include:  
*Do not reuse empty containers.*

*Offer for recycling or reconditioning, or puncture and dispose of in a sanitary landfill, or incinerate.*

*Dispose of bag in a sanitary landfill or by incineration.*

## Spill Management

A spill is any accidental release of a pesticide. As careful as people try to be, pesticide spills can and do occur. The spill may be minor, involving only a dribble from a container, or it may be major, involving large amounts of



pesticide or pesticide-containing materials such as wash water, soil, and absorbents.

You must know how to respond correctly when a spill occurs. Stopping large leaks or spills is often not simple. If you cannot manage a spill by yourself, get help. Even a spill that appears to be minor can endanger you, other people, and the environment if not handled correctly. Never leave a spill unattended. When in doubt, get assistance.

You can get help from Chemtrec (Chemical Transportation Emergency Center) by calling 1-800-424-9300. This number is for emergencies only.

The faster you can contain, absorb, and dispose of a spill, the less chance there is that it will cause harm. Clean up most spills immediately. Even minor dribbles or spills should be cleaned up before the end of the work day to keep unprotected persons or animals from being exposed.

A good way to remember the steps for a spill emergency is the "three C's: Control, Contain, Clean up.

## **Control the Spill Situation**

### **Protect yourself**

Put on appropriate personal protective equipment before contacting the spill or breathing its fumes. If you do not know how toxic the pesticide is or what type of personal protective equipment to wear, don't take a chance! Wear foil-laminate apron, footwear, and gloves; eye protection; and a respirator.

### **Stop the source**

If a small container is leaking, place it into a larger chemical-

resistant container, such as a plastic drum or bag. If a spray tank is overflowing, stop the inflow and try to cap off the tank. If a tank, hopper, or container has burst or has tipped over and is too heavy to be righted, you will not be able to stop the source.

### **Protect others**

Isolate the spill site by keeping children, other unprotected people, and animals well back. Rope off the site if necessary. If you suspect the spill contains a highly volatile or explosive pesticide, you may need to keep people back even farther. Warn people to keep out of reach of any drift or fumes. Do not use road flares or allow anyone to smoke if you suspect the leaking material is flammable.

### **Stay at the site**

Do not leave the spill site until another knowledgeable and correctly protected person arrives.

Someone should be at the spill site at all times until the spill is cleaned up.

## **Contain the Spill**

### **Confine the spill**

As soon as the source of the leak is under control, move quickly to keep the spill in as small an area as possible. Do everything you can to keep it from spreading or getting worse. For small spills, use containment snakes to surround the spill and keep it confined. For larger spills, use a shovel, a rake, or other tool or equipment to make a dike of soil, sod, or absorbent material.

### **Protect water sources**

Keep the spill out of any body of water or any pathway that will lead to water, such as a ditch, floor drain, well, or sinkhole. If the spilled pesticide is flowing towards such an area, block it or redirect it.

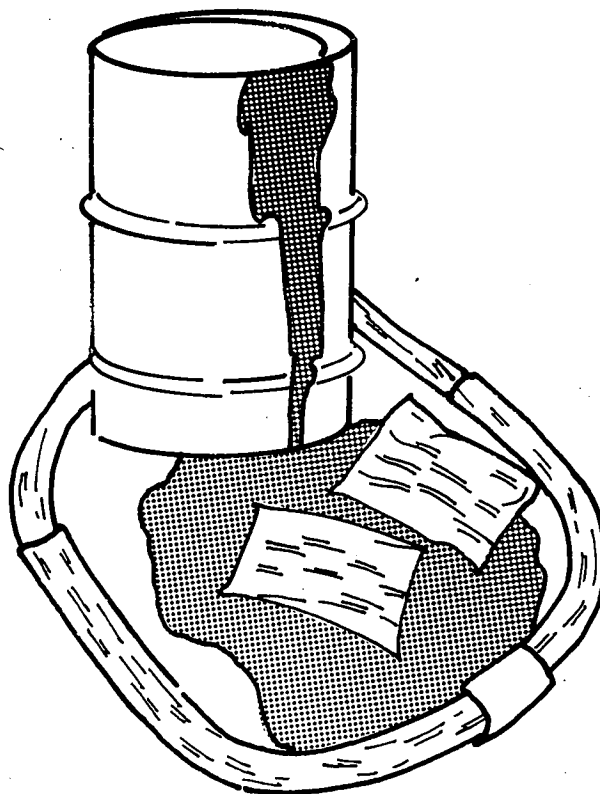

## Absorb liquids

Liquid pesticide spills can be further contained by covering the entire spill site with absorbent materials, such as spill pillows, fine sand, vermiculite, sawdust, clay, kitty litter, shredded newspaper, or absorbent pads.



## Cover dry materials

Prevent dry, dusty pesticide spills, such as dusts, powders, or granules, from becoming airborne by covering them with a sweeping compound or a plastic covering or by very lightly misting the material with water. Do not mist too much, because water may release the pesticidal action or may cause the pesticide to form clumps and be unusable.

**Warning:** Pesticides that are oxidizers, such as calcium hypochlorite (a common sanitizer) and some herbicides and desiccants that contain chlorites, should not be contained with sawdust, shredded paper, or sweeping compounds. These absorbent compounds combine with the oxidizer to create a fire hazard and could burst into flame.

## Clean Up

After you have contained the spill, you must pick up the spilled material and decontaminate the

spill site and any contaminated items or equipment.

## Clean up the spill

For spilled liquid pesticides, sweep up the absorbent material containing the pesticide and place it into a heavy-duty plastic drum or bag. Keep adding the absorbent material until the spilled liquid is soaked up and removed.

Spills of dry pesticides should be swept up for reuse if possible. Avoid contaminating the spilled materials with soil or other debris, so it can be used in the usual application equipment and will not clog the nozzles or hopper openings. However, if the dry spill has become wet or full of debris, it must be swept up and placed in a heavy-duty plastic drum or bag for disposal.

## Decontaminate the spill site

Once you have collected as much of the spilled material as possible, decontaminate the spill site as well as you can. **Do not hose down the site with water**, unless the spill is on a containment tray or pad.

If the surface on which the pesticide has spilled is nonporous, such as sealed concrete, glazed ceramic tile, or no-wax sheet flooring, use water (or the chemical listed on the label to dilute the pesticide) and a strong detergent to remove the residues of the spill from the surface. Do not allow any of the wash solution to run off the site being cleaned. Place fresh absorbent material over the wash solution until it is all soaked up. Then sweep up the absorbent material and place it in a plastic drum or bag for disposal as an excess pesticide.

If the surface upon which the pesticide has spilled is porous, such as soil, unsealed wood, or

carpet, you may have to remove the contaminated surface and dispose of it as an excess pesticide. Depending on the size of the spill and the toxicity of the pesticide, however, sometimes the site can be successfully neutralized.

## Neutralize the spill site

The labeling of a few pesticides will instruct you to neutralize a spill of that pesticide. Sometimes an authority, such as the pesticide manufacturer or Chemtrec, will also instruct you to neutralize the spill site. Follow the instructions carefully.

Neutralizing a spill often consists of mixing full-strength bleach with hydrated lime and working this mixture into the spill site with a coarse broom. Fresh absorbent material is then spread over the spill site to soak up the neutralizing liquid. This material is swept up and placed in a plastic drum or bag for disposal. You may be instructed to repeat the process several times to make sure that the site is thoroughly neutralized.

Soil is sometimes neutralized by removing and disposing of the top 2 to 3 inches and then neutralizing the remaining soil. You may be instructed to mix activated charcoal into the soil or to cover the spill site with 2 or more inches of lime and cover the lime with fresh topsoil.

Sometimes you may be instructed to cover minor spills with activated charcoal. The activated charcoal can adsorb or tie up enough pesticide to avoid adverse effects to plants and animals that contact the soil in the future. However, activated charcoal is not effective for large spills.

## Decontaminate equipment

Clean any vehicles, equipment, and personal protective equipment that were contaminated by the spill or during the containment and cleanup process. Use a strong mixture of chlorine bleach, dishwasher detergent, and water to clean the vehicles and equipment. Wash personal protective equipment thoroughly, following manufacturers' instructions and the guidelines in the personal protective equipment unit of this manual. Remember particularly that porous materials, such as brooms, leather shoes, and clothing, cannot be cleaned effectively if they are thoroughly saturated with pesticide. They should be discarded.

## Decontaminate yourself

As soon as you are finished with the spill and equipment cleanup, wash yourself thoroughly with detergent and water. Wash any part of your skin that might have been exposed, and always wash your face, neck, hands, and forearms.

## Spill Followup

For all large spills, and any spills that take place off your property, consider keeping records of your containment and cleanup activities and your conversations with authorities and the public about the spill. Photographs help to document any damage as well as the cleanup process. Report the spill to the appropriate agency, when necessary.

## Spill Assistance

Chemtrec, the Chemical Transportation Emergency Center, is a public service of the Chemical Manufacturing Association. Located in Washington, DC, Chemtrec is staffed 24 hours a day

by competent, trained personnel who are able to advise you how to manage chemical emergencies.

When you request help from Chemtrec or any other source, have the product label on hand.

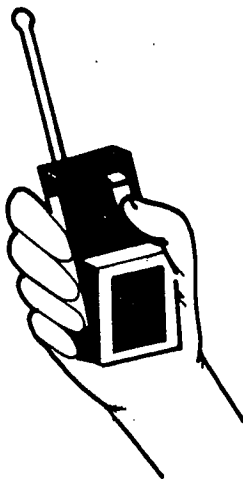

Many pesticide labels list an emergency telephone number that gives you direct access to the manufacturer and people who know how to manage emergencies for that product.

If the spill occurs on a highway, call the highway patrol or highway department right away. If the spill occurs on a county road or city street, call the county sheriff, city police, or fire department. These authorities are trained for such emergencies and will be able to assist you in your cleanup. Many local and State authorities **require** that you notify them of a pesticide spill.

If you suspect that a large spill is flammable, call the fire department for assistance. However, do not let them hose down the spill unless an authority directs them to do so.

If the spill may expose the public to pesticides or pesticide residues, contact public health officials. If anyone is poisoned by contacting the spill or if you suspect that an exposure may lead to poisoning, call the hospital

emergency room and provide them with the brand name, active ingredients, and any other labeling information about human health hazards, signs and symptoms of poisoning, and antidotes.

## Labeling Statements About Spill Management

Typical pesticide labeling instructions about spill procedures include:

*If container is broken or contents have spilled, clean up immediately. Before cleaning up, put on full-length trousers, long-sleeved shirt, protective gloves, and goggles or face shield. Soak up spill with absorbent media such as sand, earth, or other suitable material and dispose of waste at an approved waste disposal facility.*

*If the container is leaking or material is spilled, carefully sweep material into a pile. Refer to Precautionary Statements on label for hazards associated with the handling of this material. Do not walk through spilled material. Keep unauthorized people away.*

*Contact the [chemical company] emergency response team for decontamination procedures or any other emergency assistance at [telephone number].*

## Spill Kit

Keep a spill cleanup kit immediately available whenever you handle pesticides or their containers. If a spill occurs, you will not have the time or the opportunity to find all of the items.

The kit should consist of:

- telephone numbers for emergency assistance,
- sturdy gloves, footwear, and apron that are chemical-resistant



- to most pesticides, such as foil-laminate gear,
- protective eyewear,
  - an appropriate respirator, if any of the pesticides require the use of one during handling activities or for spill cleanup,
  - containment “snakes” to confine the leak or spill to a small area,
  - absorbent materials, such as spill pillows, absorbent clay, sawdust, pet litter, activated

- charcoal, vermiculite, or paper to soak up liquid spills,
- sweeping compound to keep dry spills from drifting or wafting during cleanup,
  - a shovel, broom, and dustpan (foldable brooms and shovels are handy, because they can be carried easily),
  - heavy-duty detergent,
  - a fire extinguisher rated for all types of fires,

- any other spill cleanup items specified on the labeling of any products you use regularly, and
- a sturdy plastic container that will hold the quantity of pesticide from the largest pesticide container being handled and that can be tightly closed.

All of these items can be stored in the plastic container and kept clean and in working order until a spill occurs.

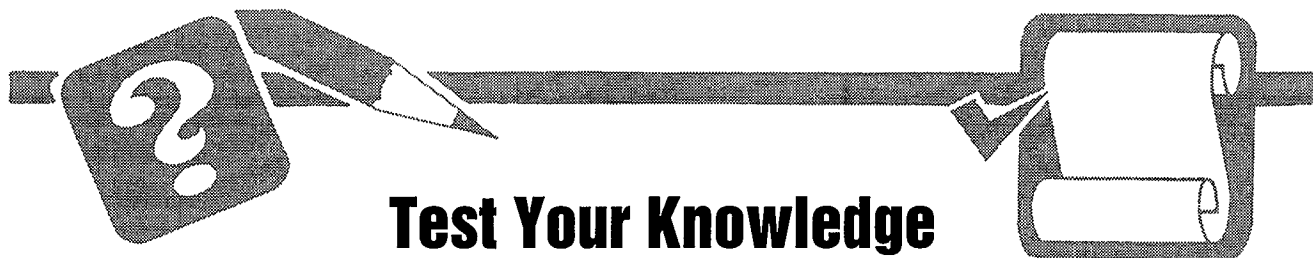

## Test Your Knowledge

**Q.** What precautions should you take when you transport pesticides in a vehicle?

- A.**
1. **Never** carry pesticides in the passenger section.
  2. **Never** allow children, other passengers, and pets to ride with pesticides.
  3. **Never** transport pesticides with food, clothing, or other things meant to be eaten or in contact with people or animals.
  4. **Never** leave your vehicle unattended when transporting pesticides in an unlocked trunk compartment or open-bed truck.
  5. **Consider** transporting highly volatile pesticides in separate trips from other chemicals.

**Q.** What steps should you take to protect pesticide containers during transport?

- A.**
1. Transport containers with intact, undamaged, and readable labels.
  2. Inspect containers to be sure that all openings are tightly closed

and that there are no pesticides on the outside of the containers.

3. Handle containers carefully.
4. Anchor all containers securely.
5. Protect paper and cardboard containers from moisture.
6. Protect pesticides from extreme temperatures.

**Q.** List four actions that you should take to establish a safe storage site.

- A.** Keep unauthorized people out; prevent water damage; control the temperature; provide adequate lighting; use nonporous materials; prevent runoff; provide clean water.

**Q.** List four actions that you should take to maintain a safe storage site.

- A.** Prevent contamination; keep labels legible; keep containers closed; use original containers; watch for damage; store volatile products separately; isolate waste products; know your inventory; consider shelf life.

**Q.** When a pesticide container is damaged, what actions can you take?

- A.**
1. Use the pesticide immediately at a site and rate allowed by the labeling.
  2. Transfer the pesticide into another pesticide container that originally held the same pesticide and has the same label still intact.
  3. Transfer the contents to a sturdy container that can be tightly closed and fasten the label to the outside of the new container.
  4. Place the entire damaged container and its contents into a suitable larger container.

**Q.** If you have excess pesticide materials that are still usable, what can you do with them?

- A.** Apply them to a site listed on the labeling; find someone else who can legally use them; return them to the dealer, formulator, or manufacturer.



**Q.** If you have pesticide wastes (other than empty containers) what can you do with them?

**A.** Dispose in a hazardous waste landfill or pesticide incinerator, or store until disposal is possible.

**Q.** List three ways to avoid the need for disposing of empty pesticide containers as wastes.

**A.** Use refillable containers; recycle or recondition the containers; use soluble packaging.

**Q.** What do the three C's of spill management stand for?

**A.** Control, Contain, Clean up.

**Q.** What should you do to control a spill situation?

**A.** Protect yourself; stop the source of the spill; protect others; stay at the site.

**Q.** How should you contain a spill?

**A.** Confine the spill; protect water sources; absorb liquids; cover dry materials.

**Q.** What should cleanup include?

**A.** Clean up the spill; decontaminate the spill site; neutralize the spill site, if necessary; decontaminate equipment; decontaminate yourself.

**Q.** Who can you call when you need help to manage a spill?

**A.** Chemtrec; emergency numbers on pesticide labeling; police department or highway patrol; fire department; public health department.

**Q.** When should you have a spill kit on hand?

**A.** Every time a pesticide or pesticide container is handled.

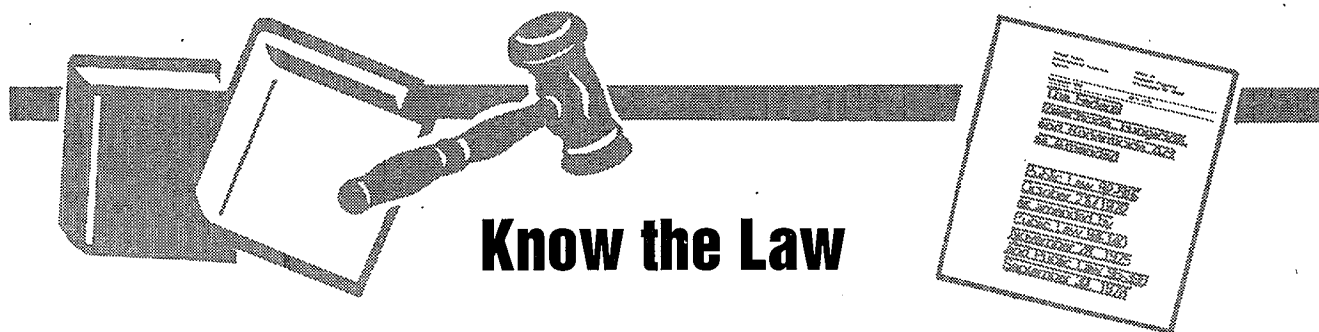

## Know the Law

If you are involved in a pesticide spill, you may need to comply with the provisions of two laws administered by the U.S. Environmental Protection Agency (EPA).

Title III of the Superfund Amendments and Reauthorization Act of 1986 (**SARA Title III**) requires you to report any accidental release (such as a spill) of any extremely hazardous substance. Reporting is required if all the following occur:

- The pesticide was spilled.
  - The pesticide is covered under SARA Title III.
  - The spill quantity was greater than the "reportable quantity" specified in the law.
  - The spill created offsite exposure.
- If such an accident occurs, you must:
- Notify the State Emergency Response Commission (SERC).
  - Notify the Local Emergency Planning Committee (LEPC).
  - Report the release to the National Response Center (1-800-424-8802).

In addition, any spill that has the potential to get into ground water or surface water must be reported to EPA under the authority of the **Clean Water Act**.

If you do not know whether the spill is large enough to be a "reportable quantity" under SARA Title III or whether the spill might get into ground water or surface water, call your local or State, or tribal pesticide agency or the EPA regional office for help.



# Appendix

## Effects of Pesticides on the Human Body

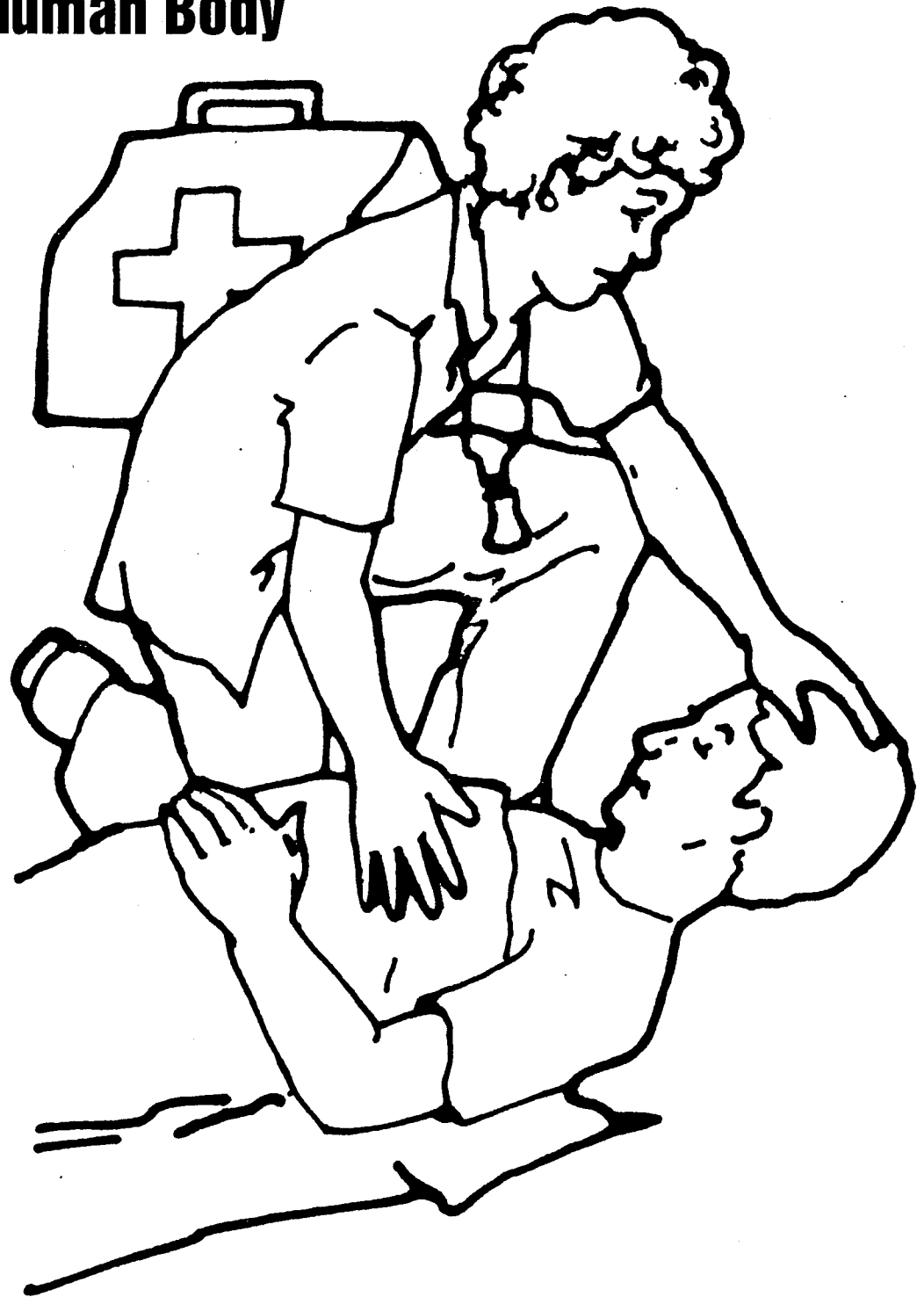

# Appendix

## Effects of Pesticides on the Human Body

---

| <b>Chemical Family</b>                        | <b>Action on Human System</b>                                  | <b>Acute Systemic Effects</b>  |
|---|--|--|
| 1. Organophosphates                           | Inhibits acetylcholinesterase enzyme in tissues.               | Headache, dizziness, weakness, shaking, nausea, stomach cramps, diarrhea, sweating.                              |
| 2. N-Methyl Carbamates                        | Reversible changes in acetylcholinesterase enzyme in tissues.  | Headache, dizziness, weakness, shaking, nausea, stomach cramps, diarrhea, sweating.                              |
| 3. Organochlorines (Chlorinated Hydrocarbons) | Disrupt function of nervous system, mainly the brain.          | Headache, dizziness, weakness, shaking, nausea, excitability, disorientation.                                    |
| 4. Pyrethrum and Pyrethrins                   | Allergen   | Slight toxic reaction.   |
| 5. Nicotine                                   | Harms nervous system.  | Nausea, headache, diarrhea, dizziness, shaking, abdominal pain, lack of coordination, sweating, salivation.      |
| 6. Rotenone                                   | Irritant   | Minimal  |
| 7. Bacillus thuringiensis                     | None known   | —  |
| 8. Gibberellic Acid                           | None known   | —  |
| 9. Pyrethroids                                | Irritant   | Minimal  |
| 10. Fluorides                                 | Harms brain and stomach.                                       | Thirst, abdominal pain, vomiting, diarrhea, headache, weakness, salivation, dilated pupils, lethargy.            |
| 11. Boric Acid                                | Irritants; Harms stomach, intestines, blood system, and brain. | Nausea, vomiting, abdominal pain, diarrhea, blood in vomit and feces, headache, weakness, tremors, restlessness. |
| 12. Chlordimeform                             | Harms bladder; Sometimes harms skin.                           | Blood in urine, frequent and painful urination, abdominal and back pain, hot sensation, sleepiness.              |

**Irritation Effects****Delayed/Allergic Effects****Type of Pesticide**

Minimal rashes, but readily absorbed through the skin.

Loss of appetite, weakness, weight loss, and general feeling of sickness, Occasionally permanent harm to brain and nerve system.

Insecticides, Acaricides

Minimal rashes, but readily absorbed through the skin.

Loss of appetite, weakness, weight loss, and general feeling of sickness.

Insecticides, Acaricides

Minimal rashes, but readily absorbed through the skin.

Some buildup in the fat tissues. May cause nervousness, weakness, and shaking. Some buildup in glands and damage cells and hormone production.

Insecticides, Acaricides

Minimal

Skin and respiratory tract allergic effects.

Insecticides, acaricides

Minimal, but readily absorbed through the skin.

—

Insecticides

Irritates skin, eyes, and respiratory tract.

—

Insecticides, acaricides

—

—

Insecticide

—

—

Growth regulator

Stinging, burning, itching, tingling, numbness of skin.

—

Insecticides

—

—

Insecticides

Irritates and burns skin and respiratory tract.

—

Insecticide

Skin rash, sweet taste.

—

Insecticide, miticides

| <b>Chemical Family</b>                         | <b>Action on Human System</b>  | <b>Acute Systemic Effects</b>  |
|--|--|--|
| 13. Propargite                                 | Irritants; Low systemic toxicity.  | Minimal  |
| 14. Diflubenzuron, Teflubenzuron               | Low systemic toxicity.   | Minimal  |
| 15. Chlorobenzilate                            | Irritants; Low systemic toxicity.  | Minimal  |
| 16. Cyhexatin                                  | Irritants; Probable harm to nervous system.  | Probable headache, nausea, vomiting, dizziness, avoidance of light.  |
| 17. Methoprene                                 | Very low systemic toxicity.  | Minimal  |
| 18. Sulfur                                     | Irritant; Low systemic toxicity.   | Minimal  |
| 19. Diethyltoluamide                           | Irritants; Low systemic toxicity, except to children.                              | Headache, restlessness, crying spells, stupor, tremors.  |
| 20. Alkyl Phthalates                           | Irritants; Low systemic toxicity.  | Stomach- and intestine-lining irritation.  |
| 21. Benzyl Benzoate                            | Irritants; Low systemic toxicity.  | Minimal  |
| 22. Arsenicals                                 | Irritants; Harms liver, kidney, brain, bone marrow, and nervous system.            | Headache, burning stomach pain, vomiting, diarrhea, dizziness; garlic odor on breath and feces.                                      |
| 23. Chlorophenoxy Compounds                    | Irritants; Harms liver, kidney, and nervous system;<br>May cause skin to discolor. | Do not remain in body; passed out within hours or days.  |
| 24. Nitrophenolic and Nitrocresolic Pesticides | Harms liver, kidneys, and nervous system.  | Headache, weakness, thirst, excessive sweating, feeling of overall illness; Yellow stain on skin, hair, and urine is characteristic. |
| 25. Pentachlorophenol                          | Irritants; Harms liver, kidneys, and nervous system.                               | Headache, weakness, nausea, excessive sweating, dizziness, fever, rapid breathing, intense thirst, vomiting, restlessness.           |

**Irritation Effects****Delayed/Allergic Effects****Type of Pesticide**

Severe skin and eye irritant.

Probable skin sensitizer.

Acaricide

—

—

Insecticide

Skin and eye irritant.

Tumors observed in laboratory animals.

Acaricide

Mild skin irritant.

—

Acaricide

—

—

Insecticide

Irritates eyes, skin, and respiratory tract.

—

Acaricide; Fungicide

Very irritating to eyes, mild skin irritation and peeling, except severe skin irritation in tropical conditions.

—

Insect repellent

Severely irritating to eyes and mucous membranes, not irritating to skin.

—

Insect repellent

Occasionally irritating to skin.

—

Acaricide

Swelling of mouth and throat, irritating to eyes, nose, and throat.

Accumulates in body; Chronic headaches, dizziness, stomach aches, salivation, low fever, garlic breath; Skin, liver, kidney, and blood system disorders; Possible skin and lung cancer.

Rodenticides, Insecticides, Acaricides, Marine antifouling compounds, Desiccants, Herbicides, Fungicides

Irritating to eyes, skin, lungs, mucous membranes.

Severe disfiguring skin condition (chloracne) in manufacturing workers.

Fungicides

Moderately irritating sensations to skin, eyes, nose, and throat.

Weight loss, cataracts, glaucoma.

Herbicides

Highly irritating to skin, eyes, nose, and throat.

Weight loss, weakness, anemia. Severe disfiguring skin disorder in manufacturing workers.

Herbicides, Defoliants, Molluscicides, Germicides, Fungicides, and Wood preservatives.

| <b>Chemical Family</b>                       | <b>Action on Human System</b>   | <b>Acute Systemic Effects</b>  |
|--|---|--|
| 26. Paraquat and Diquat                      | Irritants; Harms skin, nails, cornea, liver, kidney, linings of stomach and intestine, and heart. Severe delayed harm to lungs. | Burning pain in mouth, throat, stomach, and intestine, nausea, vomiting, diarrhea, giddiness, fever. |
| 27. Acetamides                               | Irritants   | Minimal  |
| 28. Anilides                                 | Irritants   | Minimal  |
| 29. Aliphatic Acids                          | Irritants   | Minimal  |
| 30. Benzamide                                | Irritants; Low systemic toxicity.   | Minimal  |
| 31. Benzoic Acid and Anisic Acid Derivatives | Irritants   | Minimal  |
| 32. Benzonitriles                            | Irritants   | Minimal  |
| 33. Benzothiadiazinone Dioxide               | Irritants   | Minimal  |
| 34. Dithio and Thio Carbamates               | Irritants; Very weak or no inhibition of cholinesterase enzyme in tissues.  | Nausea, vomiting, diarrhea, weakness.  |
| 35. Carbanilate                              | Irritants; Very weak or no inhibition of cholinesterase enzyme in tissues.  | Minimal  |
| 36. Chloropyridinyl                          | Irritants   | Minimal  |
| 37. Cyclohexenone Derivative                 | Irritants   | Minimal  |
| 38. Dinitroaminobenzene Derivatives          | Irritants   | Minimal  |
| 39. Fluorodinitrotoluidine Compounds         | Irritants   | Minimal  |
| 40. Isoxazolidinone                          | Irritants   | Minimal  |
| 41. Nicotinic Acid Isopropylamine Derivative | Irritants   | Minimal  |
| 42. Oxadiazolinone                           | Low systemic toxicity.  | —  |
| 43. Phosphonates                             | Irritants   | Minimal  |
| 44. Phthalates (except endothall)            | Irritants   | Minimal  |



**Irritation Effects****Delayed/Allergic Effects****Type of Pesticide**Irritates and harms skin, nails,  
nose, and eyes.

—

Herbicides

Moderately irritating to skin and  
eyes.

—

Herbicides

Irritates skin, eyes, and respiratory  
tract.

Skin sensitizers.

Herbicides

Irritates skin, eyes, and respiratory  
tract.

—

Herbicides

Occasionally irritating to skin.

—

Herbicide

Irritating to skin and respiratory  
tract.

—

Herbicides

Moderately irritating to skin and  
respiratory tract.

Skin sensitizers.

Herbicides, Fungicides

Irritates eyes and respiratory tract.

—

Herbicide

Irritates skin, eyes, mucous  
membranes, and respiratory tract.

Skin sensitizers.

Herbicides, Fungicides

Irritates skin, eyes, mucous  
membranes, and respiratory tract.

Skin sensitizers.

Herbicides

Irritates skin and eyes.

—

Herbicides

Irritant

—

Herbicides

Moderately irritating.

—

Herbicides

Mildly irritating.

—

Herbicides

Moderately irritating.

—

Herbicides

Irritating to eyes and skin.

—

Herbicides

—

—

Herbicides

Irritating to eyes, skin, and respi-  
ratory tract.

—

Herbicides

Moderately irritating to eyes

—

Herbicides

| <b>Chemical Family</b>   | <b>Action on Human System</b>  | <b>Acute Systemic Effects</b>  |
|--|--|--|
| 45. Endothall  | Harms heart, blood vessels, nervous system, and stomach and intestinal lining.           | Convulsions, shock, lack of coordination, severe burning of stomach and intestine.                           |
| 46. Picolinic Acid Compounds   | Irritants  | Minimal  |
| 47. Triazines  | Irritants; Low systemic toxicity.  | Minimal  |
| 48. Triazole   | Minimal  | Minimal  |
| 49. Uracils  | Irritants  | Minimal  |
| 50. Urea derivatives   | Irritants  | Minimal  |
| 51. Thiophthalimides   | Irritants; Low systemic toxicity   | Minimal  |
| 52. Copper   | Irritants; Harms stomach and intestinal lining, brain, liver, kidneys, and blood system. | Prompt vomiting, burning pain in chest, diarrhea, headache, sweating.  |
| 53. Organomercuric Compounds   | Harms nervous system and kidneys.  | Delirium, muscle weakness, lack of coordination, numbness in fingers and face, slurred speech, hearing loss. |
| 54. Organotin  | Irritants; Harms brain, stomach, and intestines.   | Headache, vomiting, dizziness, convulsions, stomach pain.  |
| 55. Cadmium  | Irritants; Harms lungs, kidney, blood system, liver, stomach and intestinal lining.      | Headache, cough, labored breathing, chest pain, nausea, vomiting, diarrhea, abdominal pain.                  |
| 56. Anilazine  | Irritants; Low systemic toxicity.  | Minimal  |
| 57. Cycloheximide  | Low systemic toxicity.   | —  |
| 58. Dodine   | Irritants; Low systemic toxicity.  | Nausea, vomiting, diarrhea, harm to stomach and intestinal lining.   |
| 59. Iprodione, Metalaxyl, Terrazole, Thiabendazole, Triadimefon, Triforine | Slight Irritants; Low systemic toxicity.   | Minimal  |
| 60. Coumarins, Indandiones, and Other Anticoagulants                       | Prevents blood from clotting.  | Minimal, blood in urine.   |

**Irritation Effects****Delayed/Allergic Effects****Type of Pesticide**

Irritating to eyes, skin, and mucous membranes.

—

Herbicides, Algicides

Irritating to skin, eyes, and respiratory tract.

—

Herbicides

Moderately irritating to skin, eyes, and respiratory tract.

—

Herbicides

Slight irritant effect.

—

Herbicide

Irritate skin, eyes, and respiratory tract.

—

Herbicides

Irritate eyes, skin, and mucous membranes.

—

Herbicides

Irritates skin, eyes, and respiratory tract.

Skin sensitizers.

Fungicides

Irritates skin, respiratory tract, and particularly the eyes. Corrosive to eyes.

—

Fungicides

Minimal

Weakness and lack of coordination in arms and legs; difficulty talking and swallowing; permanent nerve and brain damage.

Fungicides

Irritates eyes, skin, and respiratory tract.

—

Fungicides, Antifouling paints

Very irritating to respiratory tract.

Harm to kidneys, liver, blood system, bone structure.

Fungicides

Irritates skin.

—

Fungicides

—

—

Fungicides

Irritates skin and eyes.

—

Fungicides

Slightly irritating to eyes and skin.

—

Fungicides

Bleeding gums and nose.

—

Rodenticides

| <b>Chemical Family</b>                                    | <b>Action on Human System</b>  | <b>Acute Systemic Effects</b>  |
|---|--|--|
| 61. Yellow Phosphorous                                    | Corrosive; Highly toxic; Harms heart, blood system, liver, brain, and kidneys.                           | Breath has garlic odor; Feces may glow and smoke; Vomiting, diarrhea, lethargy, restlessness, irritability, burning pain in throat, stomach, and intestines. |
| 62. Zinc Phosphide  | Highly toxic; Harms liver, kidneys, nervous system, heart; Severe respiratory and intestinal irritation. | Intense nausea, stomach pain, excitement, chills, cough.   |
| 63. Thallium sulfate                                      | Harms nervous system, lungs, heart, blood vessels, kidney, liver, and lining of stomach and intestines.  | Stomach pain, nausea, diarrhea, salivation, headache, lethargy, tremors, muscle weakness.  |
| 64. Sodium Fluoroacetate                                  | Extremely toxic. Harms heart and brain.  | Stomach pain, vomiting, hallucination, nervousness.  |
| 65. Strychnine and Crimidine                              | Acts directly on cells in the brain and spinal cord.   | Blue skin color, violent convulsions.  |
| 66. ANTU and Norbormide                                   | Low systemic toxicity, except in huge doses.   | —  |
| 67. Red Squill  | Low systemic toxicity.   | Prompt vomiting and nausea.  |
| 68. Pyriminil   | Very toxic; Harms nervous system, brain, and area around the heart.                                      | Nausea, vomiting, diarrhea, stomach cramps, chills, confusion, weakness, chest pains.  |
| 69. Cholecalciferol                                       | Harms liver, kidney, and heart tissue.   | Weakness, headache, nausea, excess thirst and urine.   |
| 70. Napthalene  | Irritants; Harms kidneys and blood system.   | Headache, dizziness, nausea, vomiting.   |
| 71. Methylene Chloride                                    | Harms stomach, intestines, liver, and kidney.  | Fatigue, weakness.   |
| 72. Methyl Bromide  | Irritants; Serious harm to lungs; Harms nervous system.  | Coughing of frothy fluid; Severe shortness of breath, drowsiness, shaking, weakness.   |
| 73. Chloroform, Carbon Tetrachloride, Ethylene Dichloride | Irritants; Harms liver and kidneys.  | Dizziness, loss of sensation and motor power, unconsciousness.   |
| 74. Ethylene dibromide                                    | Severe irritants; Harms lungs, liver, kidney, and lining of stomach and intestine.                       | Dizziness, headache, fatigue, cough, abdominal pain.   |
| 75. Dibromochloropropane                                  | Severe irritant; Harms liver and kidney.   | Headache, nausea, vomiting, slurred speech, confusion.   |

**Irritation Effects****Delayed/Allergic Effects****Type of Pesticide**

Corrosive to skin, eyes, and mucous membranes.

—

Rodenticides

Irritates skin and mucous membranes; very irritating to respiratory tract.

—

Rodenticides

Minimal

Confusion, damage to nervous system, partial paralysis, damage to sight.

Rodenticides

Minimal

—

Rodenticides

Minimal

—

Rodenticides

—

—

Rodenticides

—

—

Rodenticides

Minimal

—

Rodenticides

—

—

Rodenticides

Irritates eyes and respiratory tract.

Skin sensitizer

Rodenticides

—

—

Fumigants

Severe burns, itching and blisters on skin.

Lack of coordination, muscle weakness, confusion.

Fumigants

Irritates respiratory tract.

—

Fumigants

Severely irritates respiratory tract. Corrosive to eyes and skin.

Damage to male reproductive organs.

Fumigants

Irritating to skin, eyes, and respiratory tract.

Sterility, eye damage.

Fumigants

| <b>Chemical Family</b>               | <b>Action on Human System</b>  | <b>Acute Systemic Effects</b>   |
|--------------------------------------|--|---|
| 76. Dichloropropene, Dichloropropane | Strong irritants; Harms liver, kidney and heart tissue.                            | Breathing spasms.   |
| 77. Paradichlorobenzene              | Irritants; Low systemic toxicity.  | Minimal   |
| 78. Ethylene Oxide, Propylene Oxide  | Irritants; Harms lungs and heart.  | Headache, nausea, vomiting, weakness, cough of frothy, bloody fluid.  |
| 79. Formaldehyde, Paraformaldehyde   | Irritants; Harms kidney, blood systems and lining of stomach and intestine.        | Asthma, abdominal pain.   |
| 80. Acrolein                         | Irritants; Harms lungs, kidneys, blood system and lining of stomach and intestine. | Asthma, abdominal pain.   |
| 81. Sulfur Dioxide                   | Strong irritant to lungs and throat.   | Respiratory distress.   |
| 82. Chloropicrin                     | Irritants  | Vomiting, abdominal pain.   |
| 83. Sulfuryl Fluoride                | Harms lungs and kidneys.   | Weakness, nausea, vomiting, cough, muscle twitching, convulsions.   |
| 84. Carbon Disulfide                 | Irritants; Harms nervous system; Delayed harm to kidney and liver.                 | Dizziness, headache, nausea, and disorientation.  |
| 85. Phosphine                        | Irritants; Harms lungs, liver, kidneys, heart, and nervous system.                 | Nausea, vomiting, dizziness, weakness, shaking, cough, difficulty in breathing, intense thirst.                   |
| 86. Hydrogen Cyanide, Acrylonitrile  | Irritants; Harms brain and heart tissues.  | Headache, nausea, constriction of throat, dizziness, nervousness, sudden unconsciousness.                         |
| 87. Metaldehyde                      | Harms stomach lining, kidney, liver.   | Salivation, cramps, vomiting, tremors.  |
| 88. Aminopyridine                    | Disrupts nervous system functions.   | Thirst, nausea, dizziness, weakness, excessive sweating.  |
| 89. Calcium Cyanamide                | Irritants  | Flushing, headache, low blood pressure, difficulty breathing.   |
| 90. Sodium Chlorate                  | Irritants; Harms intestinal lining, nervous system, and kidneys.                   | Swelling of mouth and throat, pain in esophagus, stomach and intestine, restlessness, nausea, vomiting, diarrhea. |

**Irritation Effects****Delayed/Allergic Effects****Type of Pesticide**

Severely irritate skin, eyes, and respiratory tract.

—

Fumigants

Mildly irritating to nose and eyes.

—

Fumigants

Blistering and erosion to skin.

Skin sensitizer.

Fumigants

Irritating to eyes and respiratory tract; hardens and roughens skin.

Systemic sensitizer

Fumigants

Severe eye and respiratory tract irritant; Blisters on skin.

—

Fumigants, Herbicides

Severely irritating to eyes and respiratory tract.

—

Fumigants

Severely irritating to eyes, skin, and respiratory tract.

—

Fumigants

Irritating to eyes, nose, and throat.

Harm to lungs and kidneys.

Fumigants

Irritates eyes, nose, and throat.

Painful tingling and weakness in arms and legs; loss of mental functions; blindness, deafness, paralysis.

Fumigants

Mildly irritating to respiratory tract.

—

Fumigants

—

—

Fumigants, Rodenticides

—

—

Molluscicides

—

—

Avicides

Irritates skin; May be caustic to skin and severely irritating to mucous membranes.

—

Fungicides and Herbicides

Irritates skin, eyes, and respiratory tract.

—

Herbicides, Defoliant

| <b>Chemical Family</b>      | <b>Action on Human System</b>                                   | <b>Acute Systemic Effects</b>   |
|-----------------------------|---|---|
| 91. Creosote                | Irritants; Harms brain tissue, lining of stomach and intestine. | Salivation, vomiting, abdominal pain, headache, dizziness, chills, convulsions. |
| 92. Hexachlorobenzene       | Irritants; Low systemic toxicity; chronic systemic effects.     | —   |
| 93. Pentachloronitrobenzene | Minimal   | —   |
| 94. Dichloran               | Minimal   | —   |
| 95. Chlorothalonil          | Irritants   | —   |
| 96. Chloroneb               | Irritants   | —   |
| 97. Benomyl                 | Low systemic toxicity.  | —   |



**Irritation Effects****Delayed/Allergic Effects****Type of Pesticide**

Severely irritates skin, eyes, and mucous membranes.

Skin irritation, skin discoloration; Rarely gangrene and skin cancer.

Wood preservatives, Insecticides, Disinfectants

Minimal

Injures liver and blood system.

Fungicides

—

Possible skin sensitizers

Fungicides

—

—

Fungicides

Irritates eyes, mucous membranes, and respiratory tract.

Skin sensitizer, rarely.

Fungicides

Moderately irritating to skin and mucous membranes.

—

Fungicides

—

Skin sensitizer.

Fungicides

# Index for Pesticide Effects Chart

The number following each pesticide on the list below refers to the number corresponding to the pesticide family on the EFFECTS OF PESTICIDES ON THE HUMAN BODY chart.

- 1080, 60  
 2,3,6—TBA, 31  
 2,4,5 trichlorophenoxyacetic acid, 23  
 2,4,5-T, 23  
 2,4-D, 23  
 2,4-DB, 23  
 2,4-dichlorophenoxyacetic acid, 23  
 2,4-dichlorophenoxybutyric acid, 23  
 2,4-dichlorophenoxypropionic acid, 23  
 2,4-DP, 23  
 2-methyl-3,6 dichlorobenzoic acid, 23  
 2-methyl-4-chlorophenoxy aliphatic acids and esters, 23  
 4-Aminopyridine, 88  
 4-AP, 88  
 A7 Vapam, 34  
 AASTAR, 1, 9  
 AAtack, 34  
 Aaterra, 59  
 AAtrex, 47  
 Abate, 1  
 Abathion, 1  
 Abol, 2  
 Acaraben, 15  
 Accelerate, 45  
 Accotab, 38  
 AAcothion, 1  
 acephate, 1  
 acetamides, 27  
 Acme amine, 23  
 Acme Butyl Ester, 23  
 Acme LV, 23  
 Acrex, 24  
 Acracid, 24  
 Acritet, 86  
 acrolein, 80  
 acrylaldehyde, 80  
 Acrylofume, 86  
 acrylonitrile, 86  
 Actellic, 1  
 Acti-dione, 57  
 Actispray, 57  
 Activol, 8  
 Actor, 26  
 Afalon, 50  
 Afesin, 50  
 Aficida, 2  
 Afugan, 1  
 Agritox, 1  
 Agrosan, 53  
 Agrotect, 23  
 Agrothion, 1  
 Agroxone, 23  
 Akar, 15  
 Akzo Chemie Mancozeb, 34  
 Akzo Chemic Maneb, 34  
 alachlor, 28  
 Alanox, 28  
 aldicarb, 2  
 aldrin, 3  
 Aldrite, 3  
 aliphatic acids, 29  
 alkyl phthalates, 20  
 Allethrin, 9  
 allidochlor, 27  
 Allisan, 94  
 Alon, 50  
 AIP, 85  
 alpha-naphthyl thiourea, 60  
 alphametrin, 9  
 Altosid, 17  
 aluminum phosphide, 85  
 Amaze, 1  
 Ambox, 24  
 Ambush, 9  
 Amerol, 48  
 Ametrex, 47  
 ametryn, 47  
 Amex, 38  
 amiben, 31  
 Amine 2,4,5-T, 23  
 aminocarb, 2  
 4-aminopyridine, 88  
 amino-triazole, 48  
 Amiral, 59  
 Amitrol-t, 48  
 amitrole, 48  
 Ammo, 9  
 Amoxone, 23  
 anilazine, 56  
 anilides, 28  
 anisic acid derivatives, 31  
 Ansar, 22  
 Anthio, 1  
 Anticarie, 92  
 Antimilace, 87  
 ANTU, 60  
 4-Ap, 88  
 Apachlor, 1  
 Apex, 17  
 Aphox, 2  
 Apl-Luster, 59  
 Appex, 1  
 aprocarb, 2  
 Apron, 59  
 Aquacide, 26  
 Aqua-Kleen, 23  
 Aqualin, 80  
 Aquathol, 45  
 Aquatin, 54  
 Aquazine, 47  
 Aquinite, 82  
 Arbotech, 59  
 Arelin, 50  
 Arrhenal, 22  
 Arsenal, 41  
 arsenic acid, 22  
 arsenic pesticides, 22  
 arsenic trioxide, 22  
 arsenous oxide, 22  
 Arsine, 22  
 Arsinyl, 22  
 Arsonate Liquid, 22  
 Asana, 9  
 Aspon, 1  
 Aspor, 34  
 asulam, 34  
 Asulox, 34  
 Asuntol, 1  
 AT-90, 48  
 Atranex, 47  
 Atratol, 90  
 atraton, 47  
 Atratone, 47  
 atrazine, 47  
 Aules, 34  
 Avadex, 34  
 Avicol, 93  
 Avitrol, 88  
 Azac, 34  
 Azar, 34  
 azinphos methyl, 1  
 Azodrin, 1  
 Azolan, 48  
 Azole, 48  
 bacillus thuringiensis, 7  
 Bactimos, 7  
 Bactospeine, 7  
 Bactur, 7  
 Balan, 39  
 Balfin, 39  
 Ban-Hoe, 49  
 Banvel, 23, 31  
 barban, 35  
 Barricade, 9  
 Barrier, 32  
 barthrin, 9  
 Basagran, 33  
 Basalin, 39  
 Basanite, 24  
 Basfapon, 29  
 BASF-Maneb Spritzpulver, 34  
 Bash, 1  
 Batasan, 54  
 Baygon, 2  
 Bayleton, 59  
 Bayrusil, 1  
 Baytex, 1  
 Baythion, 1  
 Baythroid, 9  
 Beet-Kleen, 35  
 Belgran, 50  
 Belmark, 9  
 bendiocarb, 2  
 Benefin, 39  
 Benex, 97  
 benfluralin, 39  
 Benlate, 97  
 benomyl, 97  
 bensulide, 1  
 bentazon, 33  
 Benzac, 31  
 benzamide, 30  
 Benzilan, 15  
 Benzofuroline, 9  
 benzoic, anisic acid derivatives, 31  
 benzonitriles, 32  
 benzothiadiazinone dioxide, 33  
 Benzyl Benzoate, 21  
 Berelex, 8  
 Bermat, 12  
 Betasan, 1  
 Bexton, 28  
 BH 2,4-D, 23  
 BH 2,4-DP, 23  
 BHC, 3  
 Bicep, 27  
 Bidrin, 1  
 binapacryl, 24  
 biopermethrin, 9  
 bioresmethrin, 9  
 Birlane, 1  
 Black Leaf 40, 5  
 Bladafum, 1  
 Bladex, 47

Bo-Ana, 1  
 Bolate, 22  
 Bolero, 34  
 Bolls-Eye, 22  
 Bolstar, 1  
 bomyl, 1  
 Bophy, 22  
 borates, 11  
 borax, 11  
 Bordeaux Mixture, 52  
 Borea, 49  
 Boric acid, 11  
 boron trioxide, 11  
 Botran, 94  
 Botrilex, 93  
 Bravo, 95  
 Brestan, 54  
 Brimstone, 18  
 Brodan, 1  
 brodifacoum, 60  
 bromacil, 49  
 bromadiolone, 60  
 Bromax, 49  
 Bromofume, 72  
 Brom-O-Gas, 72  
 Brom-O-Gaz, 72  
 bromomethane, 72  
 Bromone, 60  
 bromophos, 1  
 bromophos-ethyl, 1  
 Brom-O-Sol, 72  
 Broot, 2  
 Bud-Nip, 35  
 Bueno, 22  
 bufencarb, 2  
 Bug-Geta, 87  
 Busan, 35  
 Butoxon, 23  
 Butoxone, 23  
 butralin, 38  
 butylate, 34  
 Butyrac, 23  
 Bux, 2  
 BW-21-Z, 9  
 cacodylic acid, 22  
 Caddy, 55  
 Cadminate, 55  
 cadmium chloride, 55  
 cadmium pesticides, 55  
 cadmium sebacate, 55  
 cadmium succinate, 55  
 cadmium sulfate, 55  
 Cad-Trete, 34, 55  
 Caid, 60  
 Calar, 22  
 calcium acid methane  
   arsonate, 22  
 calcium arsenate, 22  
 calcium arsenite, 22  
 calcium cyanamide, 89  
 Caldron, 24  
 Caliber, 47  
 CAMA, 22  
 Canadien, 60  
 Can-Trol, 23  
 Caparol, 47  
 Captaf, 51  
 Captofol, 51  
 captan, 51  
 Captanex, 51  
 Carbacryl, 86  
 Carbamult, 2  
 carbanilates, 35  
 carbaryl, 2  
 Carbazinc, 34  
 carbofuran, 2  
 carbon disulfide, 84  
 carbon tetrachloride, 73  
 carbophenothion, 1  
 Carbyne, 35  
 Carpene, 97  
 Carzol, 2  
 Casoron, 32  
 Castrix, 60  
 CCN52, 9  
 CDAA, 27  
 Cekiuron, 50  
 Ceku CB, 92  
 Ckeugib, 8  
 Cekumeta, 87  
 Ckeuquat, 26  
 Cekusan, 47  
 Cekusil, 53  
 Cela W-524, 59  
 Celathion, 1  
 Celfume, 73  
 Celmer, 53  
 Celmide, 74  
 Ceresan, 53  
 Certan, 7  
 Chem Bam 34  
 Chem Fish, 6  
 Chem Pels C 22  
 Chem Rice, 28  
 Chem Zineb, 34  
 Chemox General, 24  
 Chemox PE, 24  
 Chemsect DNBP, 24  
 Chemsect DNOC, 24  
 Chem-Sen 56, 22  
 Chipco Thiram, 34  
 Chipco Turf Herbicide "D", 23  
 chloramben, 31  
 Chlordan, 3  
 chlordane, 3  
 chlordecone, 3  
 chlordimeform, 12  
 chlorfenvinphos, 1  
 chlorimuron ethyl, 50  
 chlormephos, 1  
 chlorobenzilate, 15  
 chloroform, 73  
 Chloro-IPC, 35  
 chloroneb, 96  
 chlorophacinone, 60  
 Chlorophen, 25  
 chlorophenothane, 3  
 Chlor-O-Pic, 82  
 chloropicrin, 82  
 chloropyridinyl, 36  
 Chlorothalonil, 95  
 chlorotoluron, 50  
 Chloroxone, 23  
 chloroxuron, 50  
 chlorophoxim, 1  
 chlorpropham, 35  
 chlorpyrifos, 1  
 chlorthal-dimethyl, 44  
 chlorthiophos, 1  
 cholecalciferol, 60, 69  
 Chryson, 9  
 cinerins, 4  
 Ciodrin, 1  
 cismethrin, 9  
 Classic, 50  
 Clifton Sulfur, 18  
 cloethrcarb, 2  
 ClortoCaffaro, 95  
 Clortosip, 95  
 Cobex, 39  
 Codal, 27  
 Comite, 13  
 Command, 40  
 Compound 1080, 64  
 Contrac, 60  
 Contraven, 1  
 copper acetate, 52  
 copper acetoarsenite, 22  
 copper ammonium  
   carbonate, 52  
 copper arsenite, 22  
 copper carbonate, 52  
 copper hydroxide, 52  
 Copper Lime dust, 52  
 copper linoleate, 52  
 copper naphthenate, 52  
 copper oleate, 52  
 copper oxochloride, 52  
 copper phenyl salicylate, 52  
 copper potassium sulfide, 52  
 copper quinolinolate, 52  
 copper resinate, 52  
 copper silicate, 52  
 copper sulfate, 52  
 copper sulfate tribasic, 52  
 Co-Ral, 1  
 Co-Rax, 60  
 Corozate, 34  
 Corry's Slug and Snail  
   Death, 87  
 Cosan, 18  
 Cotoran, 50  
 Cottonex, 50  
 coumachlor, 60  
 coumafene, 60  
 coumafuryl, 60  
 coumaphos, 1  
 coumarins, 60  
 coumatetralyl, 60  
 Counter, 1  
 Cov-R-Tox, 60  
 Crab-E-Rad, 22  
 Crag Turf Fungicide 531, 55  
 creosote, 91  
 crimidine, 65  
 Crisalamina, 23  
 Crisamina, 23  
 Crisazina, 47  
 Crisfolatan, 51  
 Crisfuran, 2  
 Crisquat, 26  
 Crisuron, 50  
 Crop Rider, 23  
 Crossbow, 36  
 Crotothane, 24  
 crotoxyphos, 1  
 crufomate, 1  
 cryolite, 10  
 Cuman, 34  
 cupric oxide, 52  
 cuprous oxide, 52  
 Curacron, 1  
 Curamil, 1  
 Curaterr, 2  
 Curitan, 58  
 cyanamide, 89  
 cyanide, 86  
 cyanofenphos, 1  
 cyanophos, 1  
 Cyanox, 1  
 cyclethrin, 9  
 cycloate, 34  
 cyclohexenone derivative, 37  
 cycloheximide, 57  
 Cyclon, 86  
 Cyflee, 1  
 cyfluthrin, 9  
 Cygon, 1  
 cyhexatin, 16  
 Cylan, 1  
 Cymbush, 9  
 Cymperator, 9  
 Cyolane, 1  
 Cyperkill, 9  
 cypermethrin, 9  
 Cypona, 1  
 Cyprex, 58  
 Cyrux, 9  
 cythioate, 1  
 Cytrol, 48

Cytrolane, 1  
 2,4-D, 23  
 2,4-DB, 23  
 D50, 23  
 Dacamine, 23  
 Daconate, 22  
 Daconil 2787, 95  
 Dacthal, 44  
 Dailon, 50  
 Danitol, 9  
 Dapacryl, 24  
 Dart, 14  
 Dasanit, 1  
 DBCP, 75  
 DCNA, 94  
 DCPA, 44  
 D-D, 76  
 DDD, 3  
 DDT, 3  
 DDVP, 1  
 Debroussaillant 600, 23  
 Decabane, 32  
 decamethrin, 9  
 Dechlorane, 3  
 Desic, 9  
 Ded-Weed, 23, 29  
 Ded-Weed SULV, 23  
 DEET, 19  
 DEF, 1  
 DeFend, 1  
 De-Fol-Ate, 90  
 Deftor, 50  
 DeGreen 1  
 Deiquat, 26  
 Delnav, 1  
 deltamethrin, 9  
 demeton, 1  
 demeton-S-methyl, 1  
 Denarin, 59  
 Dervan, 90  
 Des-i-cate, 45  
 Dessin, 24  
 Detamide, 19,  
 Dethdiet, 67  
 Devizeb, 34  
 Dextrone, 26  
 Dexuron, 26  
 Di-on, 50  
 Di-Tac, 22  
 Diacon, 17  
 dialifor, 1  
 diallate, 34  
 Dianex, 22  
 Diaract, 14  
 Diater, 50  
 diazinon, 1  
 Dibrom, 1  
 dibromochloropropane, 76  
 dibromoethane, 74  
 dibutylphthalate, 20  
 Dicamba, 23, 31  
 Dicarbam, 2  
 dichlobenil, 32  
 dichlofenthion, 1  
 Dichloran, 94  
 dichlorethane, 73  
 2,4-dichlorophenoxyacetic  
 acid, 23  
 2,4-dichlorophenoxybutyric  
 acid, 23  
 2,4-dichlorophenoxypropionic  
 acid, 23  
 dichloropropane, 76  
 dichloropropene, 76  
 dichloropropane plus  
 dichloropropene, 76  
 dichloropropionic acid, 29  
 dichlorvos, 1  
 dicofol, 3  
 dicrotophos, 1  
 Dicuran, 50  
 dieldrin, 3  
 Dieldrite, 3  
 dienochlor, 3  
 diethyltoluamide, 19  
 difenacoum, 60  
 difenoxuron, 50  
 Diflubenzuron, 14  
 Difolatan, 51  
 Dilic, 22  
 Dimecron, 1  
 dimefox, 1  
 dimepenthioate, 1  
 dimetan, 2  
 Dimethan, 2  
 dimethoate, 1  
 dimethrin, 9  
 dimethyl phthalate, 20  
 Dimilin, 14  
 dinitramine, 39  
 Dinitro, 24  
 Dinitro-amino-benzene  
 derivatives, 38  
 dinitroresol, 24  
 dinitrophenol, 24  
 dinobuton, 24  
 dinocap, 24  
 Dinofen, 24  
 dinopenton, 24  
 dinoprop, 24  
 dinosam, 24  
 dinoseb, 24  
 dinosulfon, 24  
 dinoterb, 24  
 dinoterbon, 24  
 Dinoxol, 23  
 Di-on, 50  
 dioxacarb, 2  
 dioxathion, 1  
 Dipel, 7  
 diphacin, 60  
 diphacinone, 60  
 Dipher, 34  
 DiptereX, 1  
 Dipyridyls, 26  
 Diquat, 26  
 Direx, 50  
 Dirimal, 38  
 disodium arsenate, 22  
 disodium methane arsonate, 22  
 disulfoton, 1  
 Disyston, 1  
 Di-tac, 22  
 Dithane, 34  
 Dithione, 1  
 ditranil, 94  
 Diurex, 50  
 Diurol, 50  
 diuron, 50  
 DLP-87, 68  
 DMA, 22  
 DMA 4, 23  
 DMP, 20  
 DNAP, 24  
 DNBP, 24  
 DNC, 24  
 DNOC, 24  
 Dodine, 97  
 Dojyopicrin, 82  
 Dolochlor, 82  
 Dormone, 23  
 Dosaflo, 50  
 Dosanex, 50  
 Dotan, 1  
 Dowpon, 29  
 2,4-DP, 23  
 DPA, 28  
 DPX 1410, 2  
 Drat, 60  
 Drawinol, 24  
 Draza, 2  
 Drexar 530, 22  
 Drexel Defol, 90  
 Drinox, 3  
 Drop-Leaf, 90  
 Drupina 90, 34  
 DSE, 34  
 DSMA, 22  
 Du-Ter, 54  
 Dual, 27  
 Duraphos, 1  
 Duratox, 1  
 Dursban, 1  
 Duter, 54  
 Dwell, 59  
 Dycarb, 2  
 Dyclomec, 32  
 Dyfonate, 1  
 Dylox, 1  
 Dynamyte, 24  
 Dyrene, 56  
 E-48, 1  
 E-601, 1  
 E-605, 1  
 Earthcide, 93  
 Easy off-D, 1  
 Ectiban, 9  
 EDB, 74  
 E-D-Bee, 74  
 EDC, 73  
 edifenphos, 1  
 Ekamet, 1  
 Ekatin, 1  
 Eksmin, 9  
 Elgetol, 24  
 Elocron, 2  
 Embutox, 23  
 emerald green, 22  
 Emisan, 53  
 Emulsamine BK, 23  
 Emulsamine E-3, 23  
 Endosan, 24  
 endosulfan, 3  
 endothall, 45  
 endothion, 1  
 Endrin, 3  
 Entex, 1  
 Envert, 23  
 EPBP, 1  
 EPN, 1  
 epoxyethane, 78  
 Eptam, 34  
 EPTC, 34  
 Eradicane, 34  
 Erazo, 60  
 Erban, 28  
 esfenvalerate, 9  
 Esgram, 26  
 Estone, 23  
 ethalfuralin, 39  
 Ethanox, 1  
 Ethazol, 59  
 ethion, 1  
 ethoprop, 1  
 ethyl parathion, 1  
 ethylan, 3  
 ethylene dibromide, 74  
 ethylene dichloride, 73  
 ethylene oxide, 78  
 ETO, 78  
 etrimfos, 1  
 Etrifolol, 2  
 Evik, 47  
 Exotherm Termil, 95  
 E-Z-Off D, 1  
 Fac, 1  
 Fall, 90  
 Famfos, 1  
 Famid, 2  
 famphur, 1

Farmco, 23  
 Ferberk, 34  
 fenamiphos, 1  
 fenchlorphos, 1  
 fenitrothion, 1  
 Fenkill, 9  
 fenophosphon, 1  
 fenpropathrin, 9  
 fensulfothion, 1  
 fenthion, 1  
 fentin acetate, 54  
 fentin chloride, 54  
 fentin hydroxide, 54  
 fenvalerate, 9  
 Ferbam, 34  
 Fermide, 34  
 Fernasan, 34  
 Fernesta, 23  
 Fernimine, 23  
 Fernos, 2  
 Fernoxone, 23  
 Ferxone, 23  
 Ficam, 2  
 Final, 60  
 Flectron, 9  
 Florocid, 10  
 fluchlorallin, 39  
 flucythrinate, 9  
 fluometuron, 50  
 fluorides, 10  
 fluorodinitrotoluidines, 39  
 fluvalinate, 9  
 FMC 9044, 24  
 Folbex, 15  
 Folcord, 9  
 Folex, 1  
 Foliafume, 6  
 Folosan, 93  
 Folpan, 51  
 Folpet, 51  
 Foltaf, 51  
 fonofos, 1  
 formaldehyde, 79  
 formalin, 79  
 formetanate, 2  
 formothion, 1  
 Formula 40, 23  
 Forron, 23  
 Fortrol, 47  
 fosamine ammonium, 43  
 fosthietan, 1  
 Fratol, 64  
 French Green, 22  
 Fumarin, 60  
 Fumitoxin, 85  
 Fundal, 12  
 Funginex, 59  
 Fungitrol II, 51  
 Fungostop, 34  
 Furadan, 2  
 furethrin, 9  
 Furloe, 35  
 furmarin, 60  
 Futura, 7  
 G 28029, 1  
 GA<sub>3</sub>, 8  
 Galecron, 12  
 Gallotox, 53  
 gamma BHC, 3  
 gamma HCH, 3  
 Gardona, 1  
 Gardoprim, 47  
 Garlon, 36  
 Gebutox, 24  
 Gesafram 50, 47  
 Gesagard, 47  
 Gesamil, 47  
 Gesapax, 47  
 Gesatamin, 47  
 Gesatop, 47  
 gibberellic acid, 8  
 Gibberellin, 8  
 Gibrel, 8  
 Glifonox, 43  
 Glycophene, 59  
 glyphosate, 43  
 Go-Go-San, 38  
 Golden Dew, 18  
 Goldquat 276, 26  
 Gordon's Amine, 23  
 Gordon's Butyl Ester, 23  
 Gordon's Dymec Turf  
   Herbicide Amine 2,4-D, 23  
 Gordon's LV 400 2,4-D, 23  
 Gordon's Mecomec, 23  
 Gordon's Phenaban 801, 23  
 Graminon, 50  
 Gramocil, 26  
 Gramonol, 26  
 Gramoxone, 26  
 Gramuron, 26  
 Granurex, 50  
 Grasalan, 50  
 Grazon, 46  
 Griffex, 47  
 Grocel, 8  
 Gusathion, 1  
 Guthion, 1  
 Gypsine, 22  
 Haipen, 51  
 Haitin, 54  
 Halizan, 87  
 Hanane, 1  
 Havoc, 60  
 HCB, 92  
 Hedonal, 23  
 Hel-Fire, 24  
 Helothion, 1  
 heptachlor, 3  
 Heptagran, 3  
 heptenophos, 1  
 Herald, 9  
 Herb-All, 22  
 Herbalt, 50  
 Herbaxon, 26  
 Herbicide 273, 45  
 Herbidal, 23  
 Herbizole, 48  
 Herbodox, 38  
 Herboxone, 26  
 hexachlorobenzene, 92  
 hexachlorocyclohexane, 3  
 Hexadrin, 3  
 Hexaferb, 34  
 Hexathane, 34  
 Hexathir, 34  
 Hexazir, 34  
 Hi-Yield Dessicant H-10, 22  
 Hoe 002784, 24  
 Hong Nien, 53  
 Hostaquick, 1  
 Hostathion, 1  
 hydrocyanic acid, 86  
 hydrogen cyanamide, 89  
 hydrogen cyanide, 86  
 Hydrothol, 45  
 Hyvar, 49  
 IBP, 1  
 Igran, 47  
 Imidan, 1  
 indandiones, 60  
 indothrin, 9  
 Inverton 235, 23  
 iodofenphos, 1  
 IP50, 50  
 Iprodione, 59  
 isofenphos, 1  
 isolan, 2  
 isomethiozin, 47  
 Isopestox, 1  
 isoprocab, 2  
 isopropalin, 38  
 isoproturon, 50  
 Isotox, 3  
 isoxathion, 1  
 Isoxazolidinone, 40  
 jasmolins, 4  
 Jones Ant Killer, 22  
 Kabat, 17  
 Kack, 22  
 Kafil, 9  
 KafilSuper, 9  
 Karathane, 24  
 Karbation, 34  
 Karmex, 50  
 Karpfos, 1  
 Kayafume, 72  
 Kelthane, 3  
 Kemate, 56  
 Kepone, 3  
 Kerb, 30  
 Kildip, 23  
 Kill-All, 22  
 Kill-Ko Rat Killer, 60  
 Kiloseb, 24  
 Kitazin, 1  
 Kiwi Lustr 277, 94  
 Klerat, 60  
 Klorex, 90  
 KM, 90  
 Knockmate, 34  
 Koban, 59  
 Kobu, 93  
 Kobutol, 93  
 Kopfume, 74  
 Korlan, 1  
 Krenite, 43  
 Kromad, 34  
 Kryocide, 10  
 Krysid, 66  
 Kumulus S, 48  
 Kusatol, 90  
 Kypfarin, 60  
 Kypman 80, 34  
 Kypzin, 34  
 Lacco Sulfur, 18  
 Lance, 2  
 Landrin, 2  
 Lannate, 2  
 Lanox, 2  
 Larvicide, 82  
 Lasso, 28  
 Lawn-Keep, 23  
 Lazo, 28  
 Lead Arsenate, 22  
 lenacil, 49  
 leptophos, 1  
 Lexone, 47  
 lindane, 17  
 Line Rider, 23  
 Linex, 50  
 Linorox, 50  
 Linurex, 50  
 linuron, 50  
 Liphadione, 60  
 Liqua-Tox, 60  
 Liquid Sulfur, 18  
 Liquiphene, 53  
 Lironion, 50  
 LM91, 60  
 Lonacol, 34  
 Lorox, 50  
 Lorsban, 1  
 MAA, 22  
 Macondray, 23  
 Magnetic 6, 18  
 Maki, 60  
 malathion, 1  
 MAMA, 22  
 Mancozeb, 34

Mancozin, 34  
 maneb, 34  
 Maneba, 34  
 Manesan, 34  
 Manex, 34  
 Manzate, 34  
 manzeb, 34  
 Manzin, 34  
 Maposol, 34  
 Marlate, 3  
 Matacil, 2  
 Mavrik, 9  
 MCPA, 23  
 MCPB, 23  
 MCPP, 23  
 M-Diphar, 34  
 MeBr, 72  
 Mecopex, 23  
 mecoprop, 23  
 Melprex, 58  
 MEMA, 53  
 MEMC, 53  
 Meothrin, 9  
 mephosfolan, 1  
 mercaptophos, 1  
 Mercuram, 34  
 mercury pesticides, 53  
 Merge 823, 22  
 Merpafol, 51  
 Merpan, 51  
 merphos, 1  
 Mersolite, 53  
 Mertect, 59  
 Mesamate, 22  
 Mesurol, 2  
 Metadelphene, 19  
 Metalaxyl, 59  
 metaldehyde, 87  
 metalkamate, 2  
 Metam-Fluid BASF, 34  
 Metam-Sodium, 34  
 Metason, 87  
 Metasystox, 1  
 metaxon, 23  
 methabenzthiazuron, 50  
 methamidophos, 1  
 Metham-Sodium, 34  
 Methane arsonic acid, 22  
 Methar 30, 22  
 methidathion, 1  
 methiocarb, 2  
 Meth-O-Gas, 72  
 methoprene, 17  
 Methoxone M, 23  
 methoxychlor, 3  
 methoxyethyl mercury  
   acetate, 53  
 methoxyethyl mercury  
   chloride, 53  
 methoxyethyl mercury  
   pesticides, 53  
 methyl bromide, 72  
 2-methyl-3,6 dichlorobenzoic  
   acide, 23  
 methyl mercury pesticides, 53  
 methyl parathion, 1  
 methyl trithion, 1  
 methylene chloride, 71  
 metobromuron, 50  
 metolachlor, 27  
 metoxuron, 50  
 metribuzin, 47  
 mevinphos, 1  
 Mezene, 34  
 MGK, 19  
 Micromite, 14  
 Mcrozul, 60  
 Miller 531, 55  
 Milogard, 47  
 Milo-Pro, 47  
 Minex, 17  
 mipafox, 1  
 MIPC, 2  
 Miracle, 23  
 mirex, 3  
 mitis green, 22  
 Mocap, 1  
 Monitor, 1  
 monoammonium methane  
   arsonate, 22  
 mono-calcium arsenite, 22  
 monocrotophos, 1  
 monolinuron, 50  
 monosodium methane  
   arsonate, 22  
 Monuron, 50  
 Morocide, 24  
 Morrocid, 24  
 MSMA, 22  
 Multamat, 2  
 Mycodifol, 51  
 N-2790, 1  
 nabam, 34  
 Nabasan, 34  
 naled, 1  
 Namekil, 87  
 naphthalene, 70  
 naphthene, 70  
 naramycin, 57  
 NaTA, 29  
 Neburex, 50  
 neburon, 50  
 Neguvon, 1  
 Nemacur, 1  
 Nemaforme, 75  
 Nemanax, 75  
 Nemaset, 75  
 Nemasol, 34  
 Nem-A-Tak, 1  
 Nematocide, 75  
 Nemispor, 34  
 Neopynamin, 9  
 Neosorexa PP580, 60  
 Nephis, 74  
 Netagrone 600, 23  
 Nexagan, 1  
 Neion, 1  
 NIA 9044, 24  
 nicotine, 5  
 nicotine sulfate, 5  
 nicotinic acid-isopropylamine  
   derivative, 41  
 Niomil, 2  
 Nitrador, 24  
 nitrochloroform, 82  
 Nitrolime, 89  
 Nitropone C, 24  
 Nix, 9  
 No Bunt, 92  
 Nomersam, 34  
 Nomolt, 14  
 norbormide, 66  
 Noxfire, 6  
 Noxfish, 6  
 NRDC 149, 9  
 Nudrin, 2  
 Nusyn-Noxfish, 6  
 Nuvanol-N, 1  
 OFF, 19  
 Oftanol, 1  
 Ofunack, 1  
 Omite, 13  
 OMPA, 1  
 Ontracac 8000, 47  
 Orthene, 1  
 Ortho Danitol, 9  
 Ortho Diquat, 26  
 Ortho Paraquat, 26  
 Orthocide, 51  
 oryzalin, 38  
 Osaquat super, 26  
 Oust, 50  
 Outflank 9  
 Ovatoxin, 12  
 Oxadiazolinone, 42  
 Oxamyl, 2  
 oxirane, 78  
 oxydemeton-methyl, 1  
 oxydeprofos, 1  
 Paarlan, 38  
 Pamisan, 53  
 Panogen, 53  
 Pansoil, 59  
 Paracide, 77  
 Para-col, 26  
 paradichlorobenzene, 77  
 paraformaldehyde, 79  
 Paraquat, 26  
 parathion, 1  
 Paris Green, 22  
 Parzate, 34  
 Pathclear, 26  
 Patoran, 50  
 Pattonex, 50  
 Pay-off, 9  
 PB-Nox, 6  
 PCNB, 93  
 PCP, 25  
 P.C.Q., 60  
 PDB, 77  
 PDQ, 23  
 PEBC, 34  
 pebulate, 34  
 Pencal, 22  
 Penchlorol, 25  
 pendimethalin, 38  
 Penite, 22  
 Pennamine D, 23  
 Pennant, 27  
 Penncozeb-M, 1  
 Penncozeb, 34  
 Penta, 25  
 Pentac, 3  
 pentachloronitrobenzene, 93  
 pentachlorophenate, 25  
 pentachlorophenol, 25  
 Pentacon, 25  
 Pentagen, 93  
 Penwar, 25  
 Permasect, 9  
 permethrin, 9  
 Perthane, 3  
 Perthrine, 9  
 Pestox, 1  
 Phalton, 51  
 Pharorid, 51  
 phencapton, 1  
 Phenostat, 54  
 phenthoate, 1  
 Phentinoacetate, 54  
 phenyl mercuric acetate, 53  
 phenyl mercury ammonium  
   acetate, 53  
 Phix, 53  
 phorate, 1  
 phosalone, 1  
 Phosdrin, 1  
 phosfolan, 1  
 phosmet, 1  
 phosphamidon, 1  
 phosphine, 85  
 phostoxin, 85  
 Phosvel, 1  
 Phosvin, 62  
 phoxim, 1  
 phthalates, 44  
 phthalthrin, 9  
 Phytar 560, 22  
 Pic-clor, 82

picloram, 46  
 picolinic acid 46  
 Pillarquat, 26  
 Pillarxone, 26  
 pindone, 60  
 pirimicarb, 2  
 pirimiphos-ethyl, 1  
 pirimiphos-methyl, 1  
 Pirimor, 2  
 Pivacin, 60  
 pival, 60  
 pivaldione, 60  
 Pivalyn, 60  
 Place-Pax, 60  
 Planotox, 23  
 Plantgard, 23  
 Plictran, 16  
 PMAA, 53  
 PMAS, 53  
 PMP Tracking Powder, 60  
 Poast, 37  
 Policar, 34  
 Polybor, 11  
 Polymone, 23  
 Polyram M, 34  
 Polytrin, 9  
 Pomarsol forte, 34  
 Pounce, 9  
 PP581, 60  
 Pramex, 9  
 Pramitol, 47  
 Prebane, 47  
 Precor, 17  
 Preeglone, 26  
 Prefar, 1  
 Preglone, 26  
 Prentox, 6  
 Priglone, 26  
 Primagram, 27  
 Primatol, 47  
 Primextra, 27  
 Primicid, 1  
 Primin, 2  
 Princep, 47  
 Proban, 1  
 Prodalumol double, 22  
 Prodan, 10  
 profenofos, 1  
 profluralin, 39  
 Pro-Gibb, 8  
 Prolate, 1  
 prolin, 60  
 promecarb, 2  
 prometon, 47  
 Prometrex, 47  
 prometryn, 47  
 pronamide, 30  
 propachlor, 28  
 Propanex, 28  
 propanil, 28  
 propargite, 13  
 propazine, 47  
 propenal 80  
 propetamphos, 1  
 propoxur, 2  
 propylene oxide, 78  
 propyl thiopyrophosphate, 1  
 prothoate, 1  
 Prowl, 38  
 Proxol, 1  
 prussic acid, 86  
 Purivel, 50  
 Pydrin, 9  
 Pynamin, 9  
 Pynosect, 9  
 Pyradex, 34  
 pyrazophos, 1  
 pyrethrins, 4  
 pyrethroids, 9  
 pyrethrum, 4  
 pyridaphenthion, 1  
 pyriminil, 68  
 Pyrobor, 11  
 Quilan, 39  
 quinalphos, 1  
 Quintox, 69  
 quintozene, 93  
 Racumin, 60  
 Rad-E-Cate, 22  
 radione, 60  
 Rampage, 69  
 Rampart, 1  
 Ramrod, 28  
 Ramucide, 60  
 Randox, 27  
 Rapid, 2  
 Ratak, 60  
 Raticate, 66  
 Ratilan, 60  
 Ratimus, 60  
 Ratomet, 60  
 Raviac, 60  
 RAX, 60  
 red squill, 67  
 Reglone, 26  
 Reglox, 26  
 Regulex, 8  
 Remasan Chloroble M, 34  
 Resisan, 94  
 resmethrin, 9  
 Revenge, 29  
 RH-787, 68  
 Rhodianebe, 34  
 Rhodthane, 3  
 Ridall-Zinc, 62  
 Ridomil, 59  
 Ripcord, 9  
 Riselect, 28  
 Rodent Cake, 60  
 Rodex, 60  
 Rodex-Blox, 60  
 Rodine, 60  
 Rody, 9  
 Ro-Neet, 34  
 ronnel 1  
 Ronstar, 42  
 Rotacide, 6  
 rotenone, 6  
 Rotenone Solution FK-11, 6  
 Roundup, 43  
 Rout (bromacil and diuron), 50  
 Rozol, 60  
 Ruelene, 1  
 Safrotin, 1  
 Safsan, 10  
 Salvo arsenic, 22  
 Salvo 2,4-D, 23  
 Sanspor, 51  
 Santophen, 25  
 Saprol, 59  
 Sarclax, 50  
 Saturn, 34  
 schradan, 1  
 Schweinfurt Green, 22  
 Scout, 9  
 Seedtox, 53  
 Selinon, 24  
 Semeron, 47  
 Sencor, 47  
 Sencoral, 47  
 Sencorex, 47  
 Seritox 50, 23  
 sethoxydim, 37  
 Setrete, 53  
 Sevin, 2  
 Shimmer-ex, 53  
 Shoxin, 66  
 siduron, 50  
 simazine, 47  
 Simazol, 48  
 Sinbar, 49  
 Sinituho, 25  
 Sinox, 24  
 Siperin, 9  
 Skeetal, 7  
 Sodar, 22  
 sodium aluminofluoride, 10  
 sodium arsenate, 22  
 sodium baborate, 11  
 sodium cacodylate, 22  
 sodium chlorate, 90  
 sodium fluoaluminat, 10  
 sodium fluoride, 10  
 sodium fluoroacetate, 64  
 sodium fluosilicate, 10  
 sodium pentaborate, 11  
 sodium pentachloro-  
 phenate, 25  
 sodium silico fluoride, 10  
 sodium tetraborate  
 decahydrate, 11  
 Sofril, 18  
 Sok-Bt, 12  
 Solasan, 34  
 Sometam, 34  
 Sonalan, 39  
 Soprabel, 22  
 Sopranebe, 34  
 Spectracide, 1  
 Spike, 50  
 Spotrete, 34  
 Spra-cal, 22  
 Spring Bak, 34  
 Spritz-Hormin/2,4-D, 23  
 Spritz-Hormit/2,4-D, 23  
 Sprout-Nip, 35  
 Spur, 9  
 S-Seven, 1  
 Stam, 28  
 Stampede, 28  
 Stirofos, 1  
 Stomp, 38  
 Strobane, 3  
 strychnine, 65  
 Subdue, 59  
 Subitex, 24  
 Sul-Cide, 18  
 Sulerex, 50  
 Sulfex, 18  
 sulfometuron methyl, 50  
 sulfotep, 1  
 sulfur, 18  
 sulfur dioxide, 81  
 sulfuryl fluoride, 83  
 sulprofos, 1  
 Sumicidin, 9  
 Sumithion, 1  
 Super Crab-E-Rad-Calar, 22  
 Super D Weedone, 23  
 Super Dal-E-Rad, 22  
 Supernox, 28  
 Superormone Concentre, 23  
 Supracide, 1  
 Surecide, 1  
 Surflan, 38  
 Surpass, 34  
 Surpur, 28  
 Sutan, 34  
 Suzu, 54  
 Swat, 1  
 Sweep, 26  
 Syllit, 58  
 Synthrin, 9  
 Systox, 1  
 2,4,5-T, 23  
 Tag, 53  
 Talan, 24  
 Talbot, 22  
 Talcord, 9

Talon, 60  
 Tamex, 38  
 Tamogam, 60  
 Tantizon, 47  
 Target MSMA, 22  
 Tattoo, 2  
 2,3,5-TBA, 31  
 TBZ, 59  
 TCA, 29  
 TCBA, 31  
 TDE, 3  
 tebuthiuron, 50  
 Tecto, 59  
 teflubenzuron, 14  
 Teknar, 7  
 Telone II, 76  
 temephos, 1  
 Temik, 2  
 1080, 64  
 Tenoran, 50  
 TEPP, 1  
 terbacil, 49  
 terbucarb, 34  
 terbufos, 1  
 terbuthylazine, 47  
 Terbutrex, 47  
 terbutryn, 47  
 terpene polychlorinates, 3  
 Terraclor, 93  
 Terraklene, 26  
 Terraneb, 96  
 Terrazole, 59  
 Terro Ant Killer, 22  
 Terr-O-Gas, 73  
 Tersan, 97  
 tetrachlorvinphos, 1  
 tetraethyl pyrophosphate, 1  
 tetrafluoron, 50  
 teframethrin, 9  
 Tetrapom, 34  
 Thallium, 63  
 thallium sulfate, 63  
 thiabendazole, 59  
 thibenzole, 59  
 Thimer, 34  
 thimet, 1  
 thiobencarb, 34  
 Thiodan, 3  
 Thioknock, 34  
 Thiolux, 18  
 thiometon, 1  
 Thion, 18  
 Thiophal, 51  
 Thiophos, 1  
 thiophthalimides, 51  
 Thiotep, 1  
 Thiotex, 34  
 Thiovit, 18  
 thiram, 34  
 Thiramad, 34  
 Thirasan, 34  
 Thistrol, 23  
 Thiuramin, 34  
 Thuricide, 7  
 Tiezene, 34  
 Tiguvon, 1  
 Tilcarex, 93  
 Tillam, 34  
 Tinestan, 54  
 Tinmate, 54  
 Tirampa, 34  
 TMTD, 34  
 TMTDS, 34  
 T-Nox, 23  
 Tolban, 39  
 Tolkan, 50  
 Toluex, 50  
 Tomarin, 60  
 Tomilon, 50  
 Tomorin, 60  
 Topitox, 60  
 Torak, 1  
 Tordon, 46  
 Tota-col, 26  
 Toxakil, 3  
 toxaphene, 3  
 Toxer Total, 26  
 Tox-Hid, 60  
 TPTA, 54  
 TPTH, 54  
 TPTOH, 54  
 TR-10, 39  
 tralomethrin, 9  
 Trametam, 34  
 Transamine, 23  
 Trans-Vert, 22  
 Treflan, 39  
 triadimefon, 59  
 triallate, 34  
 Triasyn, 56  
 Triazole, 48  
 triazophos, 1  
 Tribac, 31  
 Tribactur, 7  
 Tri-ban, 60  
 Tribunil, 50  
 Tributon, 23  
 tricalcium arsenate, 22  
 Tricarbamix Z, 34  
 trichlorfon, 1  
 trichloroacetic acid, 29  
 trichlorobenzoic acid, 31  
 trichloromethane, 73  
 trichloronate, 1  
 2,4,5 trichlorophenoxy acetic acid, 23  
 triclopyr, 36  
 Tri-Clor, 82  
 tricyclohexyl tin hydroxide, 16  
 trifluralin, 39  
 Trifocide, 24  
 Triforine, 59  
 Trifungol, 34  
 Trimangol, 34  
 Trimaton, 34  
 trimethacarb, 2  
 Trinoxol, 23  
 Tri-PCNB, 93  
 Triphenyl Tin, 54  
 Triple Tin, 54  
 Tripomol, 34  
 Triscabol, 34  
 Trithion, 1  
 Tritoflorol, 34  
 Truban, 59  
 Tuads, 34  
 Tuban, 23  
 Tubothane, 34  
 Tubotin, 54  
 Tuffcide, 95  
 Tupersan, 50  
 Turcam, 2  
 Turf-Cal, 22  
 Turflon, 36  
 U 46, 23  
 Ultracide, 1  
 Unicrop-CIPC, 35  
 Unicrop DNB, 24  
 Unicrop Maneb, 34  
 Unidron, 50  
 Uniroyal DO 14, 13  
 Unisan, 53  
 Uragan, 49  
 Urox B, 49  
 Ustaad, 9  
 Vacor, 68  
 valone, 60  
 Vancide, 34  
 Vapam, 34  
 Vapona, 1  
 Vaitox, 29  
 VC-13 Nematicide, 1  
 Vectal, 47  
 Vectobac, 7  
 Venturol, 58  
 Venzar, 49  
 vernolate, 34  
 Vertac, 24  
 Vi-Cad, 55  
 Vikane, 83  
 Volid, 60  
 Voncaptan, 51  
 Vondodine, 58  
 Vondozeb, Plus, 34  
 Vonduron, 50  
 VPM, 34  
 Vydate L, 2  
 warfarin, 60  
 Warfarin Q, 60  
 Wax Up 38  
 WBA 8107, 60  
 Weed Tox, 23  
 Weed-B-Gon, 23  
 Weed-E-Rad, 22  
 Weed-Hoe, 22  
 Weed-Rhap, 23  
 Weedar, 23  
 Weedatol, 23  
 Weedazol, 48  
 Weedol, 26  
 Weedone, 23  
 Weedtrine-D, 26  
 Weedtrol, 24  
 white arsenic, 22  
 Yasoknock, 64  
 yellow phosphorus, 61  
 Zebtox, 34  
 Zerlate, 34  
 Ziman-Dithane, 34  
 zinc arsenate, 22  
 zinc phosphide, 62  
 Zinc-Tox, 62  
 Zincmate, 34  
 zineb, 34  
 Zinosan, 34  
 ziram, 34  
 Ziramvis, 34  
 Zirasan, 34  
 Zirberk, 34  
 Zirex, 34  
 Ziride, 34  
 Zitox, 34  
 Zolone, 1  
 Zolvis, 18  
 zoocoumarin, 60  
 Zotox, 22  
 ZP, 62  
 ZR-515, 17





